

ANKATEK YAPI MALZ LTD ŐTİ



VARAN POMPA

2024-1 Fiyat Listesi



www.varanpompa.com





Company Profile

VARAN POMPA (Varan Tulumba San. ve Tic. Ltd. Şti.), Founded in 1975, is a sharply developing enterprise located in Çobançeşme, İstanbul, is mainly specialized in producing Water Pumps and Booster Systems reaching 800 different types with flows ranging from 1m³/h up to 1200m³/h, max. heads ranging from 12 m to 400 m.

Varan Pompa, in the past 45 years grew from small workshop into a improving factory. In 1987 The Company moved production facility to its building in Çobançeşme , İstanbul, located at 5 minutes from İstanbul Atatürk Airport and World Trade Center. By 1994, company's administrative and commercial activities moved to its building in Avclar, İstanbul.

We are proud of being the first company in Turkey to have produced peripheral pumps, vibration submersible pumps and pressure tanks for booster systems. Besides, our quality, on-time production and delivery has always been the principal of the company since the establishment.

In recent years with the participation of second generation in administration, the company has aimed to develop industrial pumps and booster systems. Meanwhile Varan Pompa has specialized in pumps and boosters attuned to the needs of clients. Furthermore the company has committed to adopt office automation systems and computer aided design to provide an advantageous platform for technical innovation.

Based on good reputation and quality, the company continues to produce CE, TSE certified pumps and TSEK certified booster systems certificated pumps coupled with CE, TSE, ISO9001 and ISO14001 certified motors complying with IEC, DIN, VDE and UL standards. Since 2009 Varan Pompa has launched fire-fighting pumps and also the models conforming to NFPA 20. Varan Pompa products are sold all over Turkey through 350 dealers and technical services provided by 100 agencies. Varan products are also exported to Iraq, Syria, Algeria, Albania, Serbia, Libia, Turkmenistan, Afghanistan, Cyprus, Kyrgyzstan, Mexico, Saudi Arabia, Georgia, England, Russia, Senegal, Azerbaijani, Bosnia&Herzegovina, Croatia, Romania, Poland, Macedonia, Czech Republic, Kazakhstan, Lithuania, Qatar, U.A.E.

Our main aim will always be your complete satisfaction and Our product selection will always be based on our clients' requirements, where we shall endeavour to offer what we believe to be the most appropriate equipment at reasonable price.

İçindekiler-Index



Paslanmaz Pompalar - Stainless Steel Pumps **05-27**

DWK	Paslanmaz Açık Çarklı Pompalar / S/S Open Impeller Pumps	05
BLC, HCT, DWB, CA, CY	Paslanmaz Çelik Santrifüj Pompalar / S/S Centrifugal Pumps	06-20
CMF, CM, CMI, CVL, CVF	Paslanmaz Çelik Kademeli Pompalar / S/S Multi Stage Pumps	21-27



Döküm Pompalar - Cast Iron Pumps **28-86**

QB	Sürtme Fanlı / Peripheral	28
KS, 2TCP	Çift Kademeli Monoblok / Double Stage Close-coupled	29-30
CS, VS, CPM, THF, HFM	Pis Su Pompası / Waste Water Pump	31-34
JET, SJET	Jet (Kendinden Emişli) / Jet (Self priming)	35
CAS, CES, CES-i (3000 d/d & 1500 d/d)	Salyangoz Monoblok Santrifüj / Volute Casing Close-coupled Centrifugal	36-63
ES (3000 d/d & 1500 d/d)	Salyangoz, Kaplinli Santrifüj / Volute Casing Long-coupled Centrifugal	64-83
BM, HMC, VM	Kademeli Pompalar (Noryl Fan) / Multi-Stages (Noryl Impeller)	84-86



Dalgıç/Drenaj - Submersible/Drainage Pumps **87-96**

VF	Temiz Su Drenaj Pompaları / Clean Water Drainage Pumps	88
QDP, QDS, QDX	Temiz Su Drenaj Pompaları / Clean Water Drainage Pumps	90
WQD, CUT, WQK	Pis Su Drenaj / Waste Water Drainage Pumps	91
4SD,	Derin Kuyu Dalgıç / Deep Well Submersibles	92-93



Hidrofor - Booster Systems **94-109**

Paket	Hidroforlar / Packaged Booster Sets	95-98
HMC, PVM	Noryl Çarklı Dik Pompalı Hidroforlar / Vertical Pump Boosters	99-102
CVL, CVF	Paslanmaz Dik Pompalı Hidroforlar / S/S Vertical Pump Boosters	103-109



Yangın Pompa ve Hidroforları - Fire-Fighting Pumps/Booster Sets **110-112**

PVM		112
-----	--	------------

Yedek Parçalar - Spare Parts **113-122**

Teknik Bilgiler - Technical Information **123-132**

- Fiyatlarımıza K.D.V. dahil değildir.
 - Teslimat yeri fabrika adresimizdir.
 - Özel ambalajlar ekstra ücrete tabidir.
 - Ürünler isteğe bağlı olarak kargo veya ambarla sevk edilebilir.
 - Ürünlerimiz üretim hatalarına karşı 2 yıl garantilidir.
 - Ürünün kullanım amacı harici uygulamalar ürünü garanti kapsamı dışında bırakır.
 - Ürünler fotoğrafa göre farklılık gösterebilir
 - Yetkili Servis tarafından devreye alınmayan ürünler garanti kapsamına girmez.
- (Devreye alma işleminden önce Su ve Elektrik tesisatı kullanıcı tarafından hazırlanmış olmalıdır)

Ürünler
Products



DWK (AÇIK ÇARKLI)

KOMPLE PASLANMAZ ÇELİK (AISI 316 / AISI 304) SANTRİFÜJ POMPALAR

STAINLESS STEEL(AISI 316/AISI 304) CENTRIFUGAL PUMPS (with open impeller)

TİP TYPE	Bağlantı Giriş x Çıkış Inlet x Outlet	MOTOR				m ³ /h	Debi (Q) - Capacity								FİYAT - PRICE (USD)		
		HP	kW	V	A		1	3	6	16	24	28	36	44	MOTOR MİLİNE AKUPLU		GMM.'NA AKUPLU
															AISI 316	AISI 304	AISI 316
DWK037	1¼" x 1"	0.5	0.37	220	2.4	12	10	7							-	\$175	-
DWK037T	1¼" x 1"	0.5	0.37	380	1.1	12	10	7							\$235	\$205	-
DWK100	1.5" x 1.5"	1	0.75	220	5.2	12	11	10	6						-	\$235	-
DWK100T	1.5" x 1.5"	1	0.75	380	1.8	12	11	10	6						\$330	\$280	-
DWK150T	2" x 2"	1.5	1.1	380	2.6	13	12	11	9	6					\$495	\$405	\$855
DWK200T	2" x 2"	2	1.5	380	3.5	15	14	13	12	9	6				\$520	\$425	\$935
DWK300T	2.5" x 2"	3	2.2	380	5.2	18	17	16	15	15	13	10			\$600	\$515	\$970
DWK400T	2.5" x 2"	4	3	380	6.5	22	21	20	18	17	16	14	11		\$675	\$580	\$1.020

TEKNİK ÖZELLİKLER

- Çark: Paslanmaz çelik (AISI 316)
- Partikül büyüklüğü max. Ø19 mm
- Gövde: Paslanmaz Çelik (AISI 316)
- Mil: Paslanmaz çelik (AISI 316)
- Mekanik salmastra (Karbon/Seramik/Viton)
- Çalışma sıcaklığı: +5°C ~ +90°C
- Devir Hızı: 2900d/dak.
- Koruma sınıfı: IP55
- İzolasyon sınıfı: F
- Emme derinliği: 6.5mt.

KULLANIM ALANLARI

- İçme suyu, maden suyu, saf su, Yanıcı ve Patlayıcı içermeyen temiz ve lüfatsız sıvılar.
- Max Ø19 mm partiküllü sıvılar
- Endüstriyel ve kimyasal prosesler
- Deniz suyu
- Aritma tesisleri
- Gıda sanayi (Süt, Meyve ve Salamura Suyu vs.)
- Hafif yağlar
- Soğutma ve sirkülasyon sistemleri
- Balık çiftlikleri

TECHNICAL DATA

- Impeller: S/S (AISI 316)
- Solids up to Ø19 mm
- Pump Body: S/S (AISI 316)
- Shaft: S/S (AISI 316)
- Non-Leakage: Mechanical seal (Carbon/Ceramic/Viton)
- Liquid Temp.: +5°C ~ +90°C
- Speed: 2900 rpm.
- Protection Class: IP55
- Insulation Class: F
- Suction lift: Max 6.5 m.

APPLICATIONS

- Drinking water, mineral and pure water, Non-flammable, non-explosive liquids containing no fibre
- Convey solids up to Ø19 mm
- Industrial and chemical processes
- Sea water
- Water treatment
- Food industry (milk, fruit juices, saltwater)
- Light oil
- Chiller and circulation systems

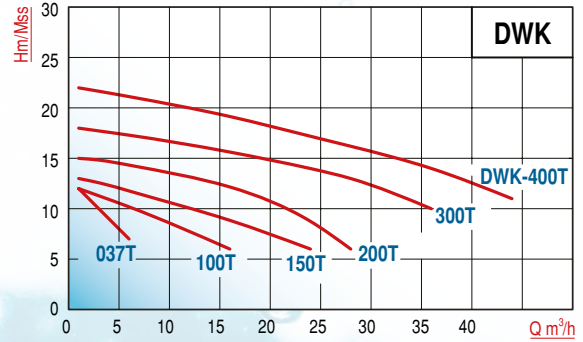
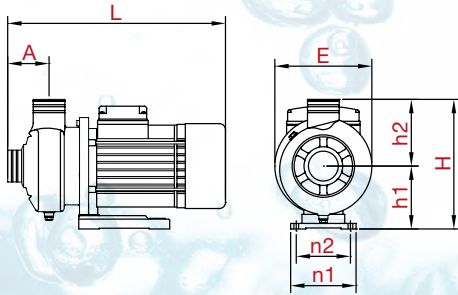

TİP TYPE	Boyutlar - Dimensions (mm)								Ağırlık - Weight
	A	L	h1	h2	H	E	n1	n2	Kg
DWK037	50	265	84	150	177	166	125	100	7
DWK037T	50	265	84	150	177	166	125	100	7
DWK100T	75	335	110	124	216	172	158	120	9
DWK150T	82	378	125	133	258	193	130	108	13
DWK200T	82	378	125	133	258	193	130	108	15
DWK300T	82	415	125	133	258	193	130	108	19
DWK400T	82	432	125	133	258	193	130	108	22

BLC

KOMPLE PASLANMAZ ÇELİK (AISI 316/AISI 304) SANTRİFÜJ POMPALAR

STAINLESS STEEL (AISI 316/AISI 304) CENTRIFUGAL PUMPS

TİP TYPE	Bağlantı		MOTOR				m ³ /h	Debi (Q) - Capacity								FİYAT - PRICE (USD)			
	Giriş x Çıkış Inlet x Outlet	HP	kW	V	A	Hm (mss)		1	2	4	6	8	11	13	18	24	AISI 316	AISI 304	
								16	15	12	9								
BLC70/037T	1 ¼" x 1"	0,5	0,37	380	1,1	Hm (mss)	16	15	12	9						\$245	-		
BLC70/075T		1	0,75				1,8	24	23	20	16	11						\$340	-
BLC120/110T		1,5	1,1				2,6	26	25	22	21	17	12					\$430	\$295
BLC120/150T		2	1,5				3,5	30	29	27	24	21	15					\$500	\$380
BLC120/185T		2,5	1,85				4,1	35	33	30	27	24						\$575	-
BLC200/185T	1.5" x 1"	2,5	1,85	4,1	30	28	27	26	24	21	19				\$585	\$410			
BLC370/185T	2" x 1.5"	2,5	1,85	4,1	24	23,5	23	22	21	20	18	15	9		\$595	\$420			

TEKNİK ÖZELLİKLER

- Fan: Paslanmaz çelik (AISI 316/AISI 304)
- Partikül büyüklüğü max. Ø2 mm
- Gövde: Paslanmaz çelik (AISI 316/AISI 304)
- Mil: Paslanmaz çelik (AISI 316/AISI 304)
- Mekanik salmastra (Karbon/Seramik/Viton)
- Çalışma ısısı: +5°C ~ +90°C
- Devir Hızı: 2900d/dak.
- Koruma sınıfı: IP55
- İzalasyon sınıfı: F
- Emme derinliği: 6.5mt.

TECHNICAL DATA

- Impeller: S/S (AISI 316/AISI 304)
- Solids up to Ø2 mm
- Pump Body: S/S (AISI 316/AISI 304)
- Shaft: S/S (AISI 316/AISI 304)
- Mechanical seal (Carbon/Ceramic/Viton)
- Liquid Temp.: +5°C ~ +90°C
- Speed: 2900 rpm.
- Protection Class: IP55
- Insulation Class: F
- Suction lift: Max 6.5 m.



KULLANIM ALANLARI

- İçme suyu, maden suyu, saf su
- Yanıcı ve Patlayıcı içermeyen temiz ve lifsiz sıvılar.
- Max. Ø2 mm partiküllü sıvılar
- Endüstriyel ve kimyasal prosesler
- Deniz suyu
- Arıtma tesisleri
- Gıda sanayi (Süt, Meyve ve Salamura Suyu vs.)
- Hafif yağlar
- Soğutma ve sirkülasyon sistemleri

APPLICATIONS

- Drinking water, mineral and pure water, Non-flammable, non-explosive liquids containing no fibre
- Convey solids up to Ø2 mm
- Industrial and chemical processes
- Sea water
- Water treatment
- Food industry (milk, fruit juices, saltwater)
- Light oil
- Chiller and circulation systems

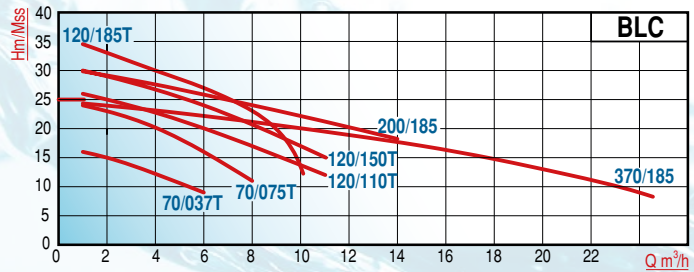
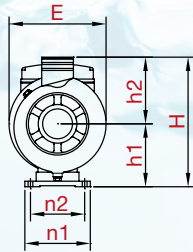
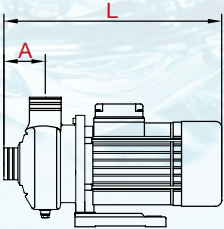

TİP TYPE	Boyutlar - Dimensions (mm)								Ağırlık - Weight Kg
	A	L	h1	h2	H	E	n1	n2	
BLC70/037T	49	265	84	95	179	166	120	100	7,5
BLC70/075T	49	315	110	110	220	213	160	140	10,6
BLC120/110T	49	337	110	110	220	213	160	140	15,6
BLC120/150T	46	373	120	120	240	234	170	150	17
BLC120/185T	46	373	120	120	240	234	170	150	18,5
BLC200/185T	49	354	110	112	222	213	160	140	22
BLC370/185T	85	386	110	142	252	213	160	140	22

HCT

KOMPLE PASLANMAZ ÇELİK (AISI 304) SANTRİFÜJ POMPALAR

STAINLESS STEEL(AISI 304) CENTRIFUGAL PUMPS

TİP TYPE	Bağlantı Giriş x Çıkış Inlet x Outlet	MOTOR				m ³ /h	Debi (Q) - Capacity								FİYAT - PRICE (USD)	
		HP	kW	V	A		1,2	2,4	3,6	4,8	6	7,2	8,4	10,8	12	AISI 304
HCT-18S-E	1 ¼" x 1"	0,5	0,37	380	1,1	16	14	12	9,5	7	4				\$180	
HCT-20S-E		0,75	0,55		1,8	20,5	19	17	14	11	8				\$185	
HCT-26S-E		1,0	0,75		2,6	24	22	19,5	17	14	11	8			\$200	
HCT-30S-E		1,5	1,1		3,5	28	26	24	22	20	18	15,5	10	6	\$255	
HCT-33S-E		2,0	1,5		4,1		29	27	25	23	21	19	13	9,5	\$260	

TEKNİK ÖZELLİKLER

- Fan: Paslanmaz çelik (AISI 304)
- Partikül büyüklüğü max. Ø2 mm
- Gövde: Paslanmaz Çelik (AISI 304)
- Mil: Paslanmaz çelik (AISI 304)
- Mekanik salmastra: Ø16 (Karbon/Seramik/NBR)
- Çalışma sıcaklığı: +5°C ~ +90°C
- Devir Hızı: 2900d/dak.
- Koruma sınıfı: IP44
- İzalasyon sınıfı: B
- Emme derinliği: 6.5mt.

TECHNICAL DATA

- Impeller: S/S (AISI 304)
- Solids up to Ø2 mm
- Pump Body: S/S (AISI 304)
- Shaft: S/S (AISI 304)
- Mechanical seal: Ø16 (Carbon/Ceramic/NBR)
- Liquid Temp.: +5°C ~ +90°C
- Speed: 2900 rpm.
- Protection Class: IP44
- Insulation Class: B
- Suction lift: Max 6.5 m.



KULLANIM ALANLARI

- İçme suyu, saf su
- Yanıcı ve Patlayıcı içermeyen Temiz ve lifsiz sıvılar.
- Max. Ø2 mm partiküllü sıvılar

APPLICATIONS

- Drinking water, pure water,
- Non-flammable, non-explosive liquids containing no fibre
- Convey solids up to Ø 2 mm

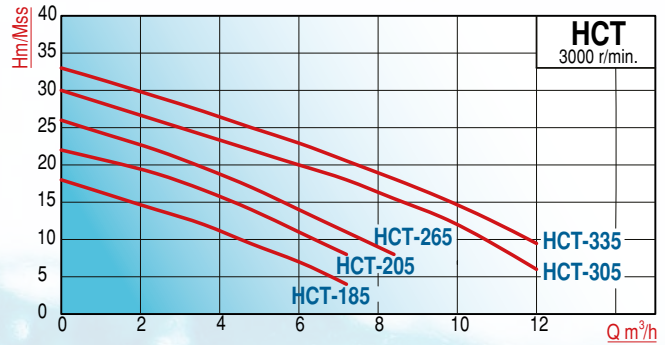
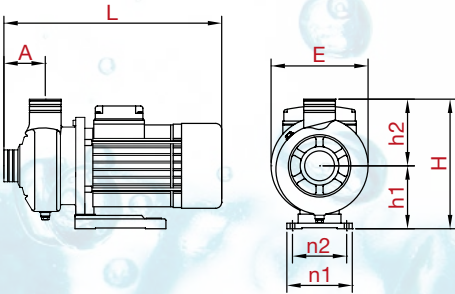

TİP TYPE	Boyutlar - Dimensions (mm)								Ağırlık - Weight	
	A	L	h1	h2	H	E	n1	n2	Kg	
HCT-18S									8	
HCT-20S									9	
HCT-26S									9,7	
HCT-30S									16	
HCT-33S									17,3	

DWB

KOMPLE PASLANMAZ ÇELİK (AISI 316/AISI 304) SANTRİFÜJ POMPALAR

STAINLESS STEEL(AISI 316/AISI 304) CENTRIFUGAL PUMPS

TİP TYPE	Bağlantı Giriş x Çıkış Inlet x Outlet	MOTOR				m ³ /h	Debi (Q) - Capacity					FİYAT - PRICE (USD)		
		HP	kW	V	A		5	10	20	30	40	MOTOR MİLİNE AKUPLE		GMM.'NA AKUPLE
												AISI 316	AISI 304	
DWB250/100T	1.5" x 1.5"	1,33	1	380		17	15	8			-	\$250	-	
DWB300/1.1T	2" x 2"	1.5	1.1	380	2.6	20	18	12	6		\$465	\$415	\$875	
DWB300/1.5T		2	1.5	380	3.5	25	22	16	10		\$510	\$435	\$930	
DWB500/2.2T		3	2.2	380	5.2	25	23	20	16	10	\$635	\$535	\$985	
DWB500/3.0T		4	3	380	6.5	28	26	23	19	12	\$715	\$600	\$1.040	

TEKNİK ÖZELLİKLER

- Çark: Paslanmaz çelik (AISI 316/AISI 304)
- Partikül büyüklüğü max. Ø4 mm
- Gövde: Paslanmaz Çelik (AISI 316/AISI 304)
- Mil: Paslanmaz çelik (AISI 316/AISI 304)
- Mekanik salmastra (Karbon/Seramik/Viton)
- Çalışma ısısı: +5°C ~ +90°C
- Devir Hızı: 2900d/dak.
- Koruma sınıfı: IP55
- İzalasyon sınıfı: F
- Emme derinliği: 6.5mt.

TECHNICAL DATA

- Impeller: S/S (AISI 316/AISI 304)
- Solids up to Ø4 mm
- Pump Body: S/S (AISI 316/AISI 304)
- Shaft: S/S (AISI 316/AISI 304)
- Non-Leakage: Mechanical seal (Carbon/Ceramic/Viton)
- Liquid Temp.: +5°C ~ +90°C
- Speed: 2900 rpm.
- Protection Class: IP55
- Insulation Class: F
- Suction lift: Max 6.5 m.

KULLANIM ALANLARI

- İçme suyu, maden suyu, saf su Yanıcı ve Patlayıcı içermeyen temiz ve lifsiz sıvılar.
- Max. Ø4 mm partiküllü sıvılar
- Endüstriyel ve kimyasal prosesler
- Deniz suyu
- Arıtma tesisleri
- Gıda sanayi (Süt, Meyve ve Salamura Suyu vs.)
- Hafif yağlar
- Soğutma ve sirkülasyon sistemleri

APPLICATIONS

- Drinking water, mineral and pure water, Non-flammable, non-explosive liquids containing no fibre
- Convey solids up to Ø4 mm
- Industrial and chemical processes
- Sea water
- Water treatment
- Food industry (milk, fruit juices, saltwater)
- Light oil
- Chiller and circulation systems

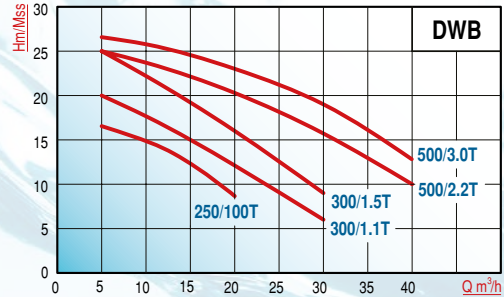
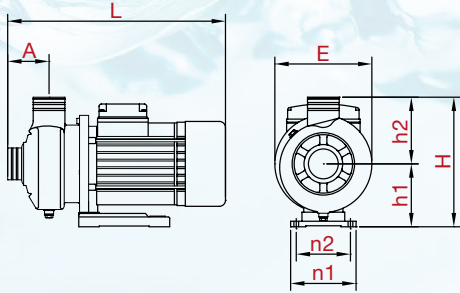

TİP TYPE	Boyutlar - Dimensions (mm)								Ağırlık - Weight Kg
	A	L	h1	h2	H	E	n1	n2	
DWB250/100T									
DWB300/1.1T	82	378	125	133	258	193	130	108	13
DWB300/1.5T	82	378	125	133	258	193	130	108	15
DWB500/2.2T	82	415	125	133	258	193	130	108	19
DWB500/3.0T	82	432	125	133	258	193	130	108	22

CA

KOMPLE PASLANMAZ ÇELİK (AISI 316/AISI 304) SANTRİFÜJ POMPALAR

STAINLESS STEEL(AISI 316/AISI 304) CENTRIFUGAL PUMPS

TİP TYPE	Bağlantı Giriş x Çıkış Inlet x Outlet	MOTOR				m ³ /h	Debi (Q) - Capacity								FİYAT - PRICE (USD)		
		HP	kW	V	A		Hm (mSS)	3	6	9	12	15	18	20	22	AISI 316	AISI 304
CA50-32-160/1.1T	2" x 1¼"	1,5	1,1	380	2,6	Hm (mSS)	22	20	19	16	15	12	10	7	\$700	\$495	
CA50-32-160/1.5T		2	1,5		3,5		26	24	23	21	18	15	12	10	\$730	\$520	
CA50-32-160/2.2T		3	2,2		4,9		31	29	28	26	24	22	20	16	\$845	\$610	
CA50-32-200/3.0T		4	3		6,3		38	37	35	34	32	30	28	26	\$1.120	\$795	
CA50-32-200/4.0T		5,5	4		9,6		52	50	48	45	43	41	39	30	\$1.310	\$955	
CA50-32-200/5.5T		7,5	5,5		11,1		62	60	58	54	52	47	42	37	\$1.385	\$1.010	
CA50-32-200/7.5T		10	7,5		14,9		67	65	64	63	61	59	57	55	\$1.540	\$1.145	

Flanşlar hariçtir. Takım fiyatı: 90 USD

TİP TYPE	Bağlantı Giriş x Çıkış Inlet x Outlet	MOTOR				m ³ /h	Debi (Q) - Capacity								FİYAT - PRICE (USD)			
		HP	kW	V	A		Hm (mSS)	5	10	15	20	25	30	35	40	AISI 316	AISI 304	
CA65-40-125/1.5T	2,5"x1,5"	2	1,5	380	3,5	Hm (mSS)	20	19	18	16	13	10,5			\$745	\$525		
CA65-40-125/2.2T		3	2,2		4,9		27	26	24	22	20	17	14			\$855	\$615	
CA65-40-125/3.0T		4	3		6,3		31	30	29	27	25	22	18			\$1.010	\$730	
CA65-40-160/4.0T		5,5	4		9,6		39	38	37	34	31	28	24	19			\$1.215	\$905
CA65-40-200/5.5T		7,5	5,5		11,1		47	46	45	44	41	38	34	30			\$1.410	\$1.015
CA65-40-200/7.5T		10	7,5		14,9		53	52	51	50	48	45	42	38			\$1.565	\$1.150
CA65-40-200/11T		15	11		21,2		70	69	68	67	66	65	64	60			\$1.950	\$1.465

Flanşlar hariçtir. Takım fiyatı: 105 USD

TİP TYPE	Bağlantı Giriş x Çıkış Inlet x Outlet	MOTOR				m ³ /h	Debi (Q) - Capacity								FİYAT - PRICE (USD)			
		HP	kW	V	A		Hm (mSS)	5	10	20	30	40	50	60	70	AISI 316	AISI 304	
CA65-50-125/3.0T	2.5" x 2"	4	3	380	6,3	Hm (mSS)	27	26	23	20	16	10			\$1.045	\$755		
CA65-50-125/4.0T		5,5	4		9,6		28	27	26	24	21	16			\$1.240	\$920		
CA65-50-160/5.5T		7,5	5,5		11,1		35	34	33	31	28	24	20			\$1.435	\$1.040	
CA65-50-200/7.5T		10	7,5		14,9		42	41	40	38	36	32	27			\$1.595	\$1.175	
CA65-50-200/9.2T		12	9,2		18,3		52	51	50	49	45	41	37			\$1.820	\$1.365	
CA65-50-200/11T		15	11		21,2		57	56	55	53	51	48	42	30			\$1.975	\$1.495
CA65-50-200/15T		20	15		28,6		69	68	67	65	62	60	57	50			\$2.200	-
CA65-50-200/18.5T		25	18,5		34,7		73	72	71	70	68	66	64	59			\$2.905	-

Flanşlar hariçtir. Takım fiyatı: 115 USD

TEKNİK ÖZELLİKLER

- Çark: Paslanmaz çelik (AISI 316)
- Partikül büyüklüğü max.04-09 mm
- Gövde: Paslanmaz Çelik (AISI 316)
- Mil: Paslanmaz çelik (AISI 316)
- Mekanik salmastra (Karbon/Seramik/Viton) Ø25-Ø30
- Çalışma Isısı: +5°C ~ +90°C
- Devir Hızı: 2900d/dak.
- Koruma sınıfı: IP55
- İzalasyon sınıfı: F
- Emme derinliği: 6.5mt.

TECHNICAL DATA

- Impeller: S/S (AISI 316)
- Solids up to Ø4 mm
- Pump Body: S/S (AISI 316)
- Shaft: S/S (AISI 316)
- Non-Leakage: Mechanical seal (Carbon/Ceramic/Viton) Ø25-Ø30
- Liquid Temp.: +5°C ~ +90°C
- Speed: 2900 rpm.
- Protection Class: IP55
- Insulation Class: F
- Suction lift: Max 6.5 m.

KULLANIM ALANLARI

- İçme suyu, maden suyu, saf su
- Yanıcı ve Patlayıcı içermeyen temiz ve lifsiz sıvılar.
- Max. Ø4 mm partiküllü sıvılar
- Endüstriyel ve kimyasal prosesler
- Deniz suyu
- Arıtma tesisleri
- Gıda sanayi (Süt, Meyve ve Salamura Suyu vs.)
- Hafif yağlar
- Soğutma ve sirkülasyon sistemleri

APPLICATIONS

- Drinking water, mineral and pure water,
- Non-flammable, non-explosive liquids containing no fibre
- Convey solids up to Ø4 mm
- Industrial and chemical processes
- Sea water
- Water treatment
- Food industry (milk, fruit juices, saltwater)
- Light oil
- Chiller and circulation systems



CA

KOMPLE PASLANMAZ ÇELİK (AISI 316/AISI 304) SANTRİFÜJ POMPALAR

STAINLESS STEEL(AISI 316/AISI 304) CENTRIFUGAL PUMPS

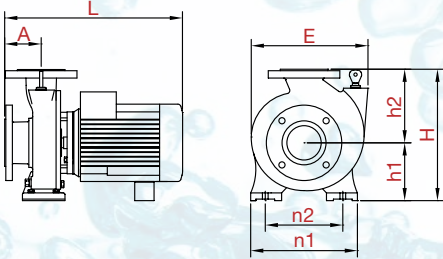
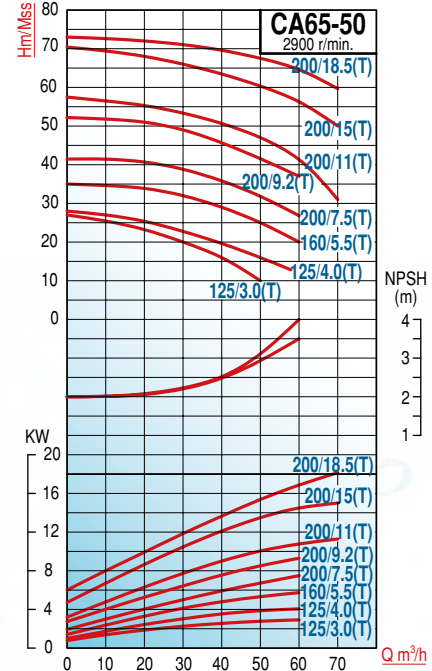
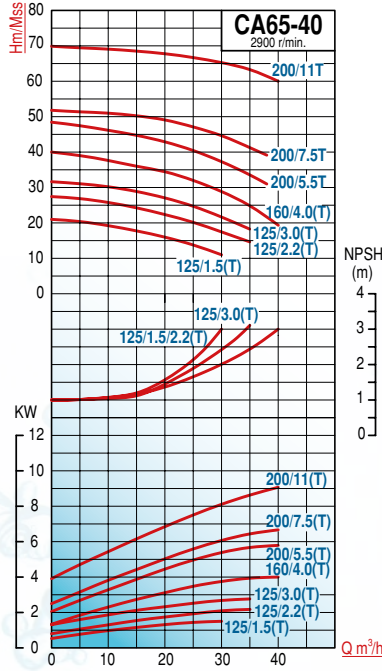
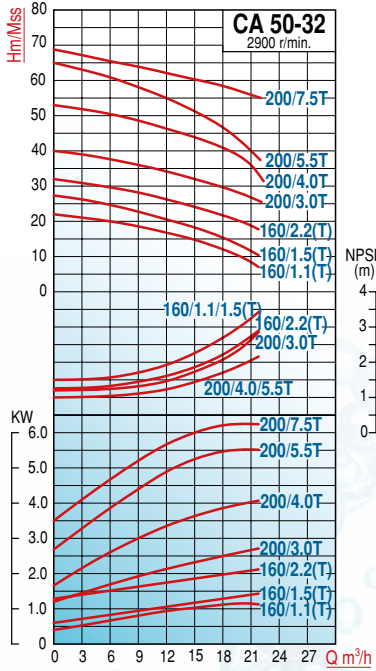

TIP TYPE	Boyutlar - Dimensions (mm)								Ağırlık - Weight
	A	L	h1	h2	H	E	n1	n2	Kg
CA50-32-160/1.1T	80	395	112	143	246	210	190	160	18
CA50-32-160/1.5T	80	395	112	143	246	210	190	160	19
CA50-32-160/2.2T	80	428	112	143	246	210	190	160	24
CA50-32-200/3.0T	80	460	160	180	279	300	240	190	34
CA50-32-200/4.0T	80	498	160	180	302	300	240	190	41
CA50-32-200/5.5T	80	532	160	180	322	300	240	190	53
CA50-32-200/7.5T	80	560	160	180	350	320	240	190	63
CA65-40-125/1.5T	80	395	112	143	255	210	190	160	20
CA65-40-125/2.2T	80	425	112	143	255	210	190	160	25
CA65-40-125/3.0T	80	460	132	160	292	250	240	190	31
CA65-40-160/4.0T	80	498	132	142	292	250	240	190	39
CA65-40-200/5.5T	100	554	160	200	322	300	264	212	53
CA65-40-200/7.5T	100	592	160	200	322	300	264	212	64
CA65-40-200/11T	100	623	160	200	339	300	264	212	81
CA 65-50-125/3.0T	80	455	132	160	295	260	240	190	31
CA 65-50-125/4.0T	80	498	132	160	295	260	240	190	39
CA 65-50-160/5.5T	100	554	160	200	360	300	264	212	53
CA 65-50-200/7.5T	100	595	160	200	360	300	264	212	64
CA 65-50-200/9.2T	100	617	160	200	360	300	264	212	72
CA 65-50-200/11T	100	623	160	200	360	300	264	212	81
CA 65-50-200/15T	100	623	160	200	360	300	264	212	95
CA 65-50-200/18.5T	100	725	160	200	260	350	264	212	132

CA
KOMPLE PASLANMAZ ÇELİK (AISI 316/AISI 304) SANTRİFÜJ POMPALAR

STAINLESS STEEL(AISI 316/AISI 304) CENTRIFUGAL PUMPS

TİP TYPE	Bağlantı Giriş x Çıkış Inlet x Outlet	MOTOR				m ³ /h	Debi (Q) - Capacity								FİYAT/ PRICE (USD)		
		HP	kW	V	A										AISI 316	AISI 304	
							40	50	60	80	100	110	120	130			
CA80-65-125/4.0T	3" x 2½"	5,5	4	380	9,6	19	18	17	13	9					\$1.385	-	
CA80-65-125/5.5T		7,5	5,5		11,1	22	21	20	18	15	13	10				\$1.450	-
CA80-65-125/7.5T		10	7,5		14,9	27	26	25	23	20	18	15				\$1.620	-
CA80-65-125/9.2T		12	9,2		18,3	30	29	28	27	25	23	22	19			\$1.860	\$1.310
CA80-65-160/11T		15	11		21,2	36	35	34	32	29	27	25	22			\$2.140	\$1.500
CA80-65-160/15T		20	15		28,6	44	43	42	39	37	36	34	32			\$2.385	-
CA80-65-200/18.5T		25	18,5		34,7	53	52	51	49	47	45	44	41			\$3.205	-
CA80-65-200/22T		30	22		41	60	59	58	56	54	53	51	49			\$4.155	-
CA80-65-200/30T		40	30		55,4	72	72	71	69	67	66	65	63			\$4.910	-

Flanşlar hariçtir. Takım fiyatı: 140 USD

TİP TYPE	Bağlantı Giriş x Çıkış Inlet x Outlet	MOTOR				m ³ /h	Debi (Q) - Capacity								FİYAT/PRICE (USD)	
		HP	kW	V	A										AISI 316	
							60	80	120	140	160	180	190	200		
CA100-80-160/11T	4"x3"	15	11	380	21,2	26	25	22	20	17	14	11			\$2.165	
CA100-80-160/15T		20	15		28,6	35	33	29	27	24	21	20	18			\$2.420
CA100-80-160/18.5T		25	18,5		34,7	38	37	35	33	30	27	25	22			\$3.215
CA100-80-200/22T		30	22		41	46	44	40	38	35	31	29	26			\$4.255
CA100-80-200/30T		40	30		55,4	57	56	53	50	47	44	42	39			\$5.010
CA100-80-200/37T		50	37		67,9	66	65	61	59	56	53	51	48			\$5.350

Flanşlar hariçtir. Takım fiyatı: 160 USD

TEKNİK ÖZELLİKLER

- Çark: Paslanmaz çelik (AISI 316)
- Partikül büyüklüğü max. Ø18 mm
- Gövde: Paslanmaz Çelik (AISI 316)
- Mil: Paslanmaz çelik (AISI 316)
- Mekanik salmastra (Karbon/Seramik/Viton) Ø25
- Çalışma ısısı: +5°C ~ +90°C
- Devir Hızı: 2900d/dak.
- Koruma sınıfı: IP55
- İzalasyon sınıfı: F
- Emme derinliği: 6.5mt.

TECHNICAL DATA

- Impeller: S/S (AISI 316)
- Solids up to Ø4 mm
- Pump Body: S/S (AISI 316)
- Shaft: S/S (AISI 316)
- Non-Leakage: Mechanical seal (Carbon/Ceramic/Viton) Ø25
- Liquid Temp.: +5°C ~ +90°C
- Speed: 2900 rpm.
- Protection Class: IP55
- Insulation Class: F
- Suction lift: Max 6.5 m.

KULLANIM ALANLARI

- İçme suyu, maden suyu, saf su
- Yanıcı ve Patlayıcı içermeyen temiz ve lifsiz sıvılar.
- Max. Ø4 mm partiküllü sıvılar
- Endüstriyel ve kimyasal prosesler
- Deniz suyu
- Arıtma tesisleri
- Gıda sanayi (Süt, Meyve ve Salamura Suyu vs.)
- Hafif yağlar
- Soğutma ve sirkülasyon sistemleri

APPLICATIONS

- Drinking water, mineral and pure water, Non-flammable, non-explosive liquids containing no fibre
- Convey solids up to Ø4 mm
- Industrial and chemical processes
- Sea water
- Water treatment
- Food industry (milk, fruit juices, saltwater)
- Light oil
- Chiller and circulation systems



CA

KOMPLE PASLANMAZ ÇELİK (AISI 316/AISI 304) SANTRİFÜJ POMPALAR

STAINLESS STEEL(AISI 316/AISI 304) CENTRIFUGAL PUMPS

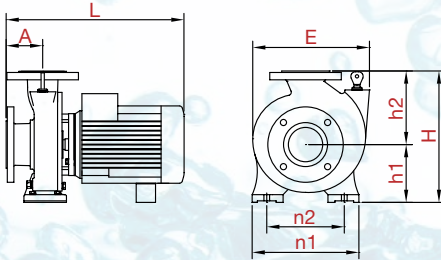
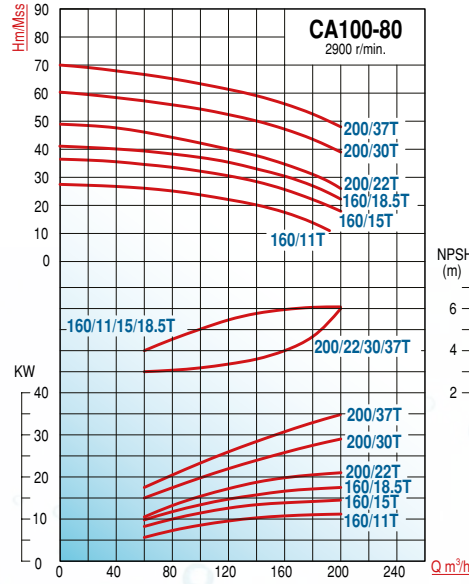
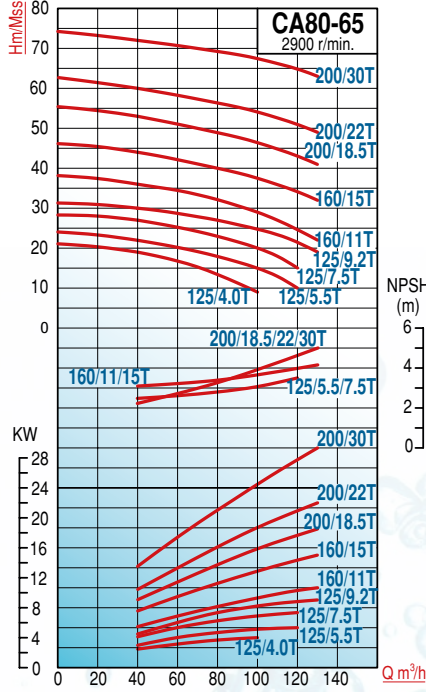

TİP TYPE	Boyutlar - Dimensions (mm)								Ağırlık - Weight
	A	L	h1	h2	H	E	n1	n2	Kg
CA80-65-125/4.0T	100	514	160	180	340	256	250	212	40
CA80-65-125/5.5T	100	530	160	180	340	256	250	212	55
CA80-65-125/7.5T	100	568	160	180	340	256	250	212	70
CA80-65-125/9.2T	100	636	160	180	340	256	250	212	78
CA80-65-160/11T	100	620	160	200	360	300	250	212	90
CA80-65-160/15T	100	662	160	200	360	300	250	212	100
CA80-65-200/18.5T	100	748	180	225	405	300	290	250	140
CA80-65-200/22T	100	776	180	225	405	300	290	250	210
CA80-65-200/30T	100	844	180	225	405	300	290	250	280
CA100-80-160/11T	125	669	180	225	405	256	290	250	91
CA100-80-160/15T	125	711	180	225	405	256	290	250	102
CA100-80-160/18.5T	125	769	180	225	405	256	290	250	142
CA100-80-200/22T	125	811	180	250	430	300	320	280	212
CA100-80-200/30T	125	880	200	250	450	300	320	280	282
CA100-80-200/37T	125	880	200	250	450	300	320	280	300

CY (3000 d/d)

KOMPLE PASLANMAZ ÇELİK (AISI 316) KAPLINLI SANTRİFÜJ POMPALAR

STAINLESS STEEL(AISI 316) CENTRIFUGAL PUMPS

TİP TYPE	Bağlantı	MOTOR				m ³ /h	Debi (Q) - Capacity								FİYAT - PRICE (USD)
	Giriş x Çıkış	HP	kW	V	A		Pompa & Mot. Akuple								
	Inlet x Outlet						Pump & Mot. Coupled								
CY50-32-160/1.1T	2" x 1¼"	1,5	1,1	380	2,4	22	20	19	16	15	12	10	7	\$1.355	
CY50-32-160/1.5T		2	1,5		3,2	26	24	23	21	18	15	12	10	\$1.410	
CY50-32-160/2.2T		3	2,2		4,7	31	29	28	26	24	22	20	16	\$1.475	
CY50-32-200/3.0T		4	3		6,3	38	37	35	34	32	30	28	26	\$1.700	
CY50-32-200/4.0T		5,5	4		9,6	52	50	48	45	43	41	39	30	\$1.810	
CY50-32-200/5.5T		7,5	5,5		11,1	62	60	58	54	52	47	42	37	\$1.875	

Flanşlar hariçtir. Takım fiyatı: 90 USD

TİP TYPE	Bağlantı	MOTOR				m ³ /h	Debi (Q) - Capacity								FİYAT - PRICE (USD)
	Giriş x Çıkış	HP	kW	V	A		Pompa & Mot. Akuple								
	Inlet x Outlet						Pump & Mot. Coupled								
CY65-40-125/1.5T	2½"x1½"	2	1,5	380	3,2	20	19	18	16	13	10,5			\$1.420	
CY65-40-125/2.2T		3	2,2	380	4,7	27	26	24	22	20	17	14		\$1.485	
CY65-40-125/3.0T		4	3	380	6,3	31	30	29	27	25	22	18		\$1.615	
CY65-40-160/4.0T		5,5	4	380	9,6	39	38	37	34	31	28	24	19	\$1.730	
CY65-40-200/5.5T		7,5	5,5	380	11,1	47	46	45	44	41	38	34	30	\$1.900	
CY65-40-200/7.5T		10	7,5	380	14,9	53	52	51	50	48	45	42	38	\$1.985	
CY65-40-200/11T		15	11	380	21,2	70	69	68	67	66	65	64	60	\$2.395	

Flanşlar hariçtir. Takım fiyatı: 105 USD

TİP TYPE	Bağlantı	MOTOR				m ³ /h	Debi (Q) - Capacity								FİYAT - PRICE (USD)
	Giriş x Çıkış	HP	kW	V	A		Pompa & Mot. Akuple								
	Inlet x Outlet						Pump & Mot. Coupled								
CY65-50-125/3.0T	2½" x 2"	4	3	380	6,3	27	26	23	20	16	10			\$1.635	
CY65-50-125/4.0T		5,5	4	380	9,6	28	27	26	24	21	16			\$1.745	
CY65-50-160/5.5T		7,5	5,5	380	11,1	35	34	33	31	28	24	20		\$1.915	
CY65-50-200/7.5T		10	7,5	380	14,9	42	41	40	38	36	32	27		\$2.005	
CY65-50-200/11T		15	11	380	21,2	57	56	55	53	51	48	42	30	\$2.410	
CY65-50-200/15T		20	15	380	28,6	69	68	67	65	62	60	57	50	\$2.865	
CY65-50-200/18.5T		25	18,5	380	34,7	73	72	71	70	68	66	64	59	\$2.980	

Flanşlar hariçtir. Takım fiyatı: 115 USD

TEKNİK ÖZELLİKLER

- Çark: Paslanmaz çelik (AISI 316)
- Partikül büyüklüğü max.04-09mm
- Gövde: Paslanmaz Çelik (AISI 316)
- Mil: Paslanmaz çelik (AISI 316)
- Mekanik salmastra (Karbon/Seramik/Viton) Ø25
- Çalışma ısısı: +5°C ~ +90°C
- Devir Hızı: 2900d/dak.
- Koruma sınıfı: IP55
- İzasyon sınıfı: F
- Emme derinliği: 6.5mt.

TECHNICAL DATA

- Impeller: S/S (AISI 316)
- Solids up to 04 mm
- Pump Body: S/S (AISI 316)
- Shaft: S/S (AISI 316)
- Non-Leakage: Mechanical seal (Carbon/Ceramic/Viton) Ø25
- Liquid Temp.: +5°C ~ +90°C
- Speed: 2900 rpm.
- Protection Class: IP55
- Insulation Class: F
- Suction lift: Max 6.5 m.

KULLANIM ALANLARI

- İçme suyu, maden suyu, saf su Yanıcı ve Patlayıcı içermeyen temiz ve lıfızlı sıvılar.
- Max. 04 mm partiküllü sıvılar
- Endüstriyel ve kimyasal prosesler
- Deniz suyu
- Aritma tesisleri
- Gıda sanayi (Süt, Meyve ve Salamura Suyu vs.)
- Hafif yağlar
- Soğutma ve sirkülasyon sistemleri

APPLICATIONS

- Drinking water, mineral and pure water,
- Non-flammable, non-explosive liquids containing no fibre
- Convey solids up to 04 mm
- Industrial and chemical processes
- Sea water
- Water treatment
- Food industry (milk, fruit juices, saltwater)
- Light oil
- Chiller and circulation systems

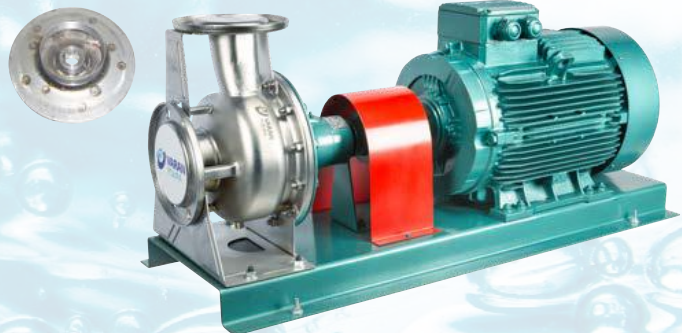

CY (3000 d/d)

KOMPLE PASLANMAZ ÇELİK (AISI 316)KAPLINLİ SANTRİFÜJ POMPALAR

STAINLESS STEEL(AISI 316) CENTRIFUGAL PUMPS

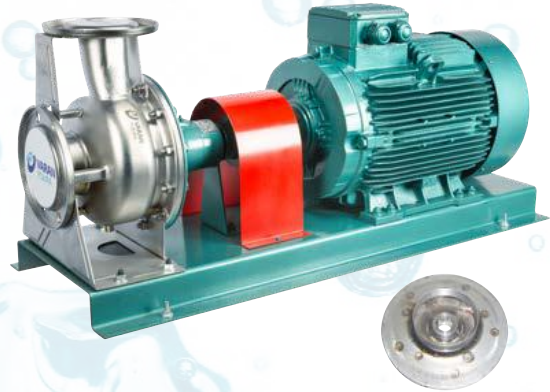
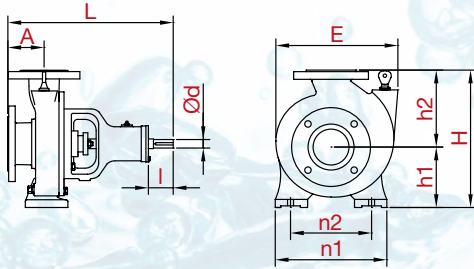
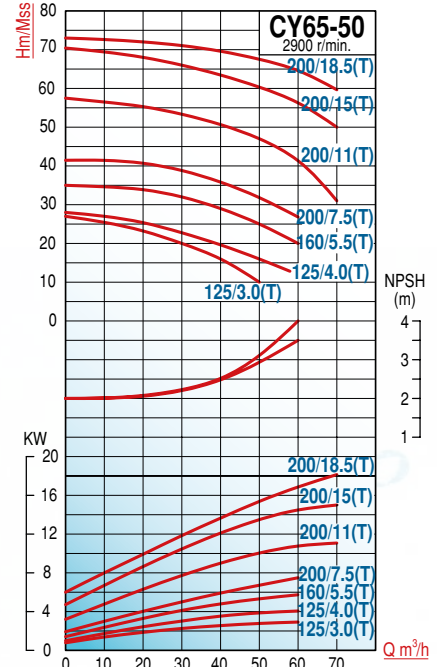
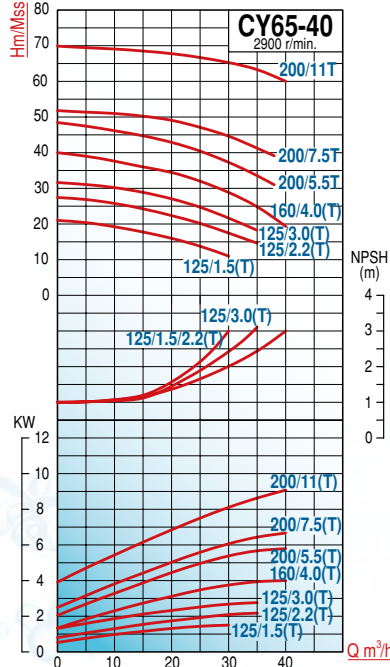
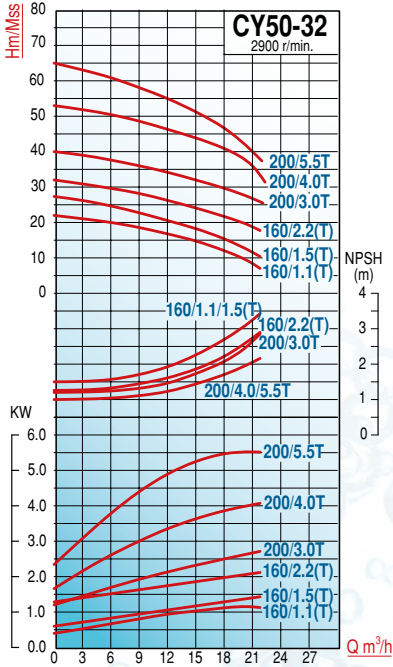

TİP TYPE	Boyutlar - Dimensions (mm)										Tek Pompa	
	A	L	h1	h2	H	E	n1	n2	i	d	Ağırlık - Weight (kg)	
CY50-32-160/1.1T	80	359	112	143	246	210	190	160	71	22	18	
CY50-32-160/1.5T	80	359	112	143	246	210	190	160	71	22	18	
CY50-32-160/2.2T	80	359	112	143	246	210	190	160	71	22	18	
CY50-32-200/3.0T	80	353	160	180	279	300	240	190	62	22	27	
CY50-32-200/4.0T	80	353	160	180	302	300	240	190	62	22	27	
CY50-32-200/5.5T	80	353	160	180	322	300	240	190	62	22	27	
CY65-40-125/1.5T	80	359	112	143	255	210	190	160	71	22	18	
CY65-40-125/2.2T	80	359	112	143	255	210	190	160	71	22	18	
CY65-40-125/3.0T	80	352	132	160	292	250	240	190	71	22	22	
CY65-40-200/4.0T	80	352	132	142	292	250	240	190	71	22	22	
CY65-40-200/5.5T	100	375	160	200	322	300	264	212	62	22	28	
CY65-40-200/7.5T	100	375	160	200	322	300	264	212	62	22	28	
CY65-40-200/11T	100	375	160	200	339	300	264	212	62	22	28	
CY65-50-125/3.0T	80	352	132	160	295	260	240	190	71	22	23	
CY65-50-125/4.0T	80	352	132	160	295	260	240	190	71	22	23	
CY65-50-160/5.5T	100	375	160	200	360	300	264	212	62	22	28	
CY65-50-200/7.5T	100	375	160	200	360	300	264	212	62	22	28	
CY65-50-200/11T	100	375	160	200	360	300	264	212	62	22	28	
CY65-50-200/15T	100	375	160	200	360	300	264	212	62	22	28	
CY65-50-200/18.5T	100	375	160	200	360	350	264	212	62	22	28	

CY (3000 d/d)

KOMPLE PASLANMAZ ÇELİK (AISI 316) KAPLINLI SANTRİFÜJ POMPALAR

STAINLESS STEEL(AISI 316) CENTRIFUGAL PUMPS

TİP TYPE	Bağlantı	MOTOR				m ³ /h Hm (mSS)	Debi (Q) - Capacity								FİYAT - PRICE (USD)
	Giriş x Çıkış Inlet x Outlet	HP	kW	V	A		40	50	60	80	100	110	120	130	Pompa & Mot. Akuple Pump & Mot. Coupled
CY80-65-125/4.0T	3"x 2½"	5,5	4	380	9,6	19	18	17	13	9				\$1.690	
CY80-65-125/5.5T		7,5	5,5	380	11,1	22	21	20	18	15	13	10		\$1.740	
CY80-65-125/7.5T		10	7,5	380	14,9	27	26	25	23	20	18	15		\$1.830	
CY80-65-125/9.2T		12	9,2	380	18,3	30	29	28	27	25	23	22	19	\$2.295	
CY80-65-160/11T		15	11	380	21,2	36	35	34	32	29	27	25	22	\$2.370	
CY80-65-160/15T		20	15	380	28,6	44	43	42	39	37	36	34	32	\$2.685	
CY80-65-200/18.5T		25	18,5	380	34,7	53	52	51	49	47	45	44	41	\$2.975	
CY80-65-200/22T		30	22	380	41	60	59	58	56	54	53	51	49	\$3.350	
CY80-65-200/30T		40	30	380	55,4	72	72	71	69	67	66	65	63	\$4.285	

Flanşlar hariçtir. Takım fiyatı: 140 USD

TİP TYPE	Bağlantı	MOTOR				m ³ /h Hm (mSS)	Debi (Q) - Capacity								FİYAT - PRICE (USD)
	Giriş x Çıkış Inlet x Outlet	HP	kW	V	A		60	80	120	140	160	180	190	200	Pompa & Mot. Akuple Pump & Mot. Coupled
CY100-80-160/11T	4" x 3"	15	11	380	21,6	26	25	22	20	17	14	11		\$2.350	
CY100-80-160/15T		20,0	15	380	28,6	35	33	29	27	24	21	20	18	\$2.660	
CY100-80-160/18.5T		25,0	18,5	380	34,7	38	37	35	33	30	27	25	22	\$2.930	
CY100-80-200/22T		30	22	380	41	46	44	40	38	35	31	29	26	\$3.425	
CY100-80-200/30T		40	30	380	55,4	57	56	53	50	47	44	42	39	\$4.365	
CY100-80-200/37T		50	37	380	68	66	65	61	59	56	53	51	48	\$4.715	

Flanşlar hariçtir. Takım fiyatı: 160 USD

TEKNİK ÖZELLİKLER

- Çark: Paslanmaz çelik (AISI 316)
- Partikül büyüklüğü max. Ø18 mm
- Gövde: Paslanmaz Çelik (AISI 316)
- Mil: Paslanmaz çelik (AISI 316)
- Mekanik salmastra (Karbon/Seramik/Viton) Ø25 & Ø30
- Çalışma ısısı: +5°C ~ +90°C
- Devir Hızı: 2900d/dak.
- Koruma sınıfı: IP55
- İzalasyon sınıfı: F
- Emme derinliği: 6.5mt.

TECHNICAL DATA

- Impeller: S/S (AISI 316)
- Solids up to Ø4 mm
- Pump Body: S/S (AISI 316)
- Shaft: S/S (AISI 316)
- Non-Leakage: Mechanical seal (Carbon/Ceramic/Viton) Ø25 & Ø30
- Liquid Temp.: +5°C ~ +90°C
- Speed: 2900 rpm.
- Protection Class: IP55
- Insulation Class: F
- Suction lift: Max 6.5 m.

APPLICATIONS

- Drinking water, mineral and pure water, Non-flammable, non-explosive liquids containing no fibre
- Convey solids up to Ø4 mm
- Industrial and chemical processes
- Sea water
- Water treatment
- Food industry (milk, fruit juices, saltwater)
- Light oil
- Chiller and circulation systems

KULLANIM ALANLARI

- İçme suyu, maden suyu, saf su
- Yanıcı ve Patlayıcı içermeyen temiz ve lifsiz sıvılar.
- Max. Ø4 mm partiküllü sıvılar
- Endüstriyel ve kimyasal prosesler
- Deniz suyu
- Arıtma tesisleri
- Gıda sanayi (Süt, Meyve ve Salamura Suyu vs.)
- Hafif yağlar
- Soğutma ve sirkülasyon sistemleri

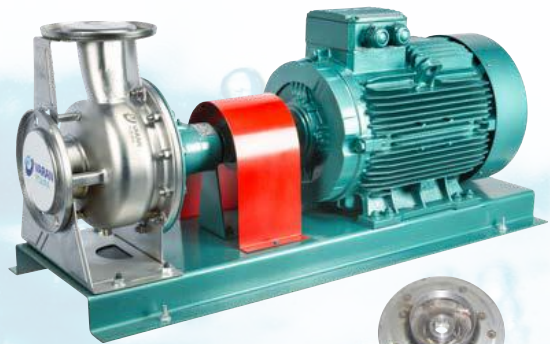

CY (3000 d/d)

KOMPLE PASLANMAZ ÇELİK (AISI 316) KAPLINLİ SANTRİFÜJ POMPALAR

STAINLESS STEEL(AISI 316) CENTRIFUGAL PUMPS

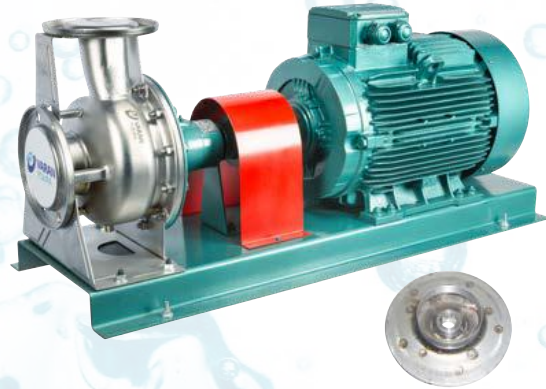
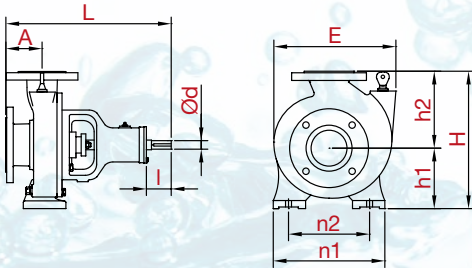
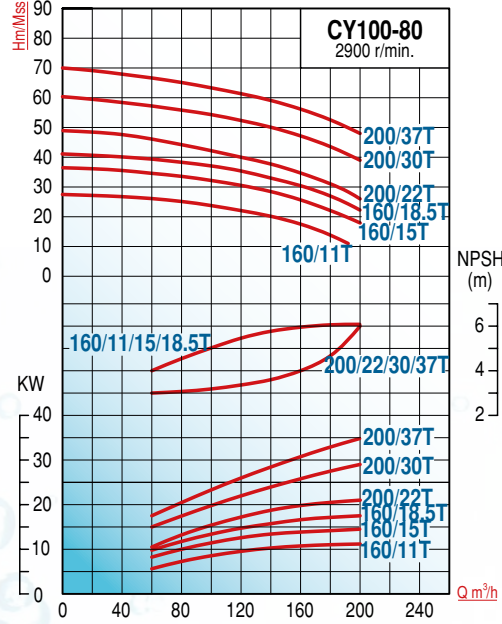
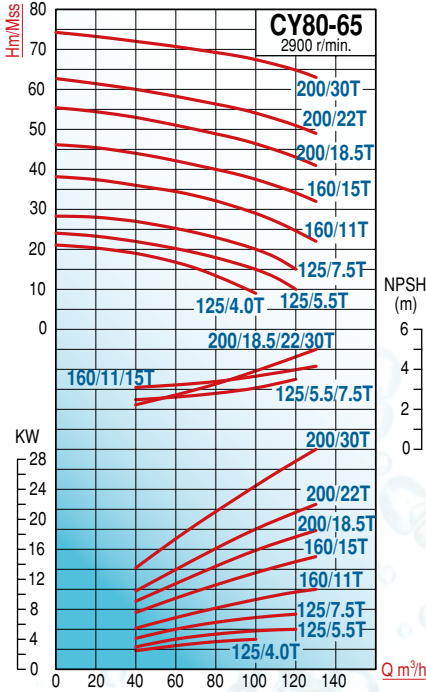

TİP TYPE	Boyutlar - Dimensions (mm)										Tek Pompa	
	A	L	h1	h2	H	E	n1	n2	ı	d	Ağırlık - Weight (kg)	
CY80-65-125/4.0T	100	377	160	180	340	256	250	212	71	22	24	
CY80-65-125/5.5T	100	377	160	180	340	256	250	212	71	22	24	
CY80-65-125/7.5T	100	377	160	180	340	256	250	212	71	22	24	
CY80-65-160/11T	100	377	160	200	360	300	250	212	62	22	29	
CY80-65-160/15T	100	377	160	200	360	300	250	212	62	22	29	
CY80-65-200/18.5T	100	376	180	225	405	300	290	250	62	22	29	
CY80-65-200/22T	100	376	180	225	405	300	290	250	62	22	29	
CY80-65-200/30T	100	376	180	225	405	300	290	250	62	22	30	
CY100-80-160/11T	125	407	180	225	405	256	290	250	71	22	26	
CY100-80-160/15T	125	407	180	225	405	256	290	250	71	22	26	
CY100-80-160/18.5T	125	407	180	225	405	256	290	250	71	22	26	
CY100-80-200/22T	125	412	180	250	430	300	320	280	62	22	31	
CY100-80-200/30T	125	412	200	250	450	300	320	280	62	22	31	
CY100-80-200/37T	125	412	200	250	450	300	320	280	62	22	31	

CY (1500 d/d)

KOMPLE PASLANMAZ ÇELİK (AISI 316) KAPLINLI SANTRİFÜJ POMPALAR

STAINLESS STEEL(AISI 316) CENTRIFUGAL PUMPS

TİP TYPE	Bağlantı		MOTOR				m ³ /h Hm (mss)	Debi (Q) - Capacity										FİYAT - PRICE (USD)	
	Giriş x Çıkış		HP	kW	V	A												Pompa & Mot. Akuple	
	Inlet x Outlet																	Pump & Mot. Coupled	
CY50-32-160/0.25T	2" x 1¼"		0,33	0,25	380	0,85	5,5	5,2	5	4,7	4,3	3,9	3,5	2,8	\$1.305				
CY50-32-160/0.37T			0,5	0,37	380	1	7	6,4	6,3	6,2	5,9	5,7	5	4,2	\$1.320				
CY50-32-200/0.37T			0,5	0,37	380	1	8,7	8,5	8,2	8	7,7	7,4	7	6,5	\$1.485				
CY50-32-200/0.55T			0,75	0,55	380	1,45	12	11,8	11,4	11	10,5	10	9,4	8,4	\$1.525				
CY50-32-200/0.75T			1	0,75	380	1,95	17,3	17	16,7	16,5	15,6	15	14,8	13,6	\$1.605				

Flanşlar hariçtir. Takım fiyatı: 90 USD

TİP TYPE	Bağlantı		MOTOR				m ³ /h Hm (mss)	Debi (Q) - Capacity								FİYAT - PRICE (USD)	
	Giriş x Çıkış		HP	kW	V	A										Pompa & Mot. Akuple	
	Inlet x Outlet															Pump & Mot. Coupled	
CY65-40-125/0.37T	2½" x 1½"		0,5	0,37	380	1	4,8	4,5	4,3	4	3,4	2,6	2	1,8	\$1.325		
CY65-40-125/0.37T			0,5	0,37	380	1	6,3	6,1	5,8	5,5	4,9	4,2	3,6	3,4	\$1.330		
CY65-40-125/0.55T			0,75	0,55	380	1,45	7,1	6,5	6,4	6,1	5,5	4,8	4,3	4,1	\$1.425		
CY65-40-160/0.55T			0,75	0,55	380	1,45	8,5	8,1	7,8	7,5	6,9	6,2	5,6	5,4	\$1.450		
CY65-40-200/1,1T			1,5	1,1	380	2,6	11	10,7	10,4	10,1	9,6	9	8,6	8,3	\$1.540		
CY65-40-200/1.1T			1,5	1,1	380	2,6	12,7	12,5	12,2	11,9	11,2	10,4	9,7	9,4	\$1.675		
CY65-40-200/1.5T			2	1,5	380	3,4	17,8	17,5	17,2	16,9	16,2	15,3	14,6	14,2	\$1.765		

Flanşlar hariçtir. Takım fiyatı: 105 USD

TİP TYPE	Bağlantı		MOTOR				m ³ /h Hm (mss)	Debi (Q) - Capacity								FİYAT - PRICE (USD)	
	Giriş x Çıkış		HP	kW	V	A										Pompa & Mot. Akuple	
	Inlet x Outlet															Pump & Mot. Coupled	
CY65-50-125/0.55T	2½" x 2"		0,75	0,55	380	1,45	4,9	4,7	4,4	4,2	3,8	3	2,6	2	\$1.660		
CY65-50-125/0.55T			0,75	0,55	380	1,45	5,8	5,6	5,4	5,2	4,9	4,1	3,7	3,2	\$1.675		
CY65-50-160/1.1T			1,5	1,1	380	2,6	7,7	7,5	7,2	6,9	6,5	5,6	5	4,5	\$1.905		
CY65-50-200/1.1T			1,5	1,1	380	2,6	9	8,8	8,5	8,2	7,8	6,9	6,3	5,8	\$1.910		
CY65-50-200/1.5T			2	1,5	380	3,4	12,1	11,8	11,4	11	10,5	9,3	8,6	8	\$1.990		
CY65-50-200/1.5T			2	1,5	380	3,4	13	12,7	12,3	11,9	11,5	10,5	9,8	9,1	\$1.995		
CY65-50-200/2.2T			3	2,2	380	4,85	17,7	17,5	17,2	16,8	16,4	15,4	14,8	14	\$2.080		
CY65-50-200/3.0T			4	3	380	6,42	18,6	18	17,5	17,1	16,7	16	15,6	15	\$2.140		

Flanşlar hariçtir. Takım fiyatı: 115 USD

TEKNİK ÖZELLİKLER

- Çark: Paslanmaz çelik (AISI 316)
- Partikül büyüklüğü max. Ø4 mm
- Gövde: Paslanmaz Çelik (AISI 316)
- Mil: Paslanmaz çelik (AISI 316)
- Mekanik salmastra (Karbon/Seramik/Viton) Ø25
- Çalışma ısısı: +5°C ~ +90°C
- Devir Hızı: 2900d/dak.
- Koruma sınıfı: IP55
- İzalasyon sınıfı: F
- Emme derinliği: 6.5mt.

TECHNICAL DATA

- Impeller: S/S (AISI 316)
- Solids up to Ø4 mm
- Pump Body: S/S (AISI 316)
- Shaft: S/S (AISI 316)
- Non-Leakage: Mechanical seal (Carbon/Ceramic/Viton) Ø25
- Liquid Temp.: +5°C ~ +90°C
- Speed: 2900 rpm.
- Protection Class: IP55
- Insulation Class: F
- Suction lift: Max 6.5 m.

KULLANIM ALANLARI

- İçme suyu, maden suyu, saf su
- Yanıcı ve Patlayıcı içermeyen temiz ve lifsiz sıvılar.
- Max. Ø4 mm partiküllü sıvılar
- Endüstriyel ve kimyasal prosesler
- Deniz suyu
- Arıtma tesisleri
- Gıda sanayi (Süt, Meyve ve Salamura Suyu vs.)
- Hafif yağlar
- Soğutma ve sirkülasyon sistemleri

APPLICATIONS

- Drinking water, mineral and pure water, Non-flammable, non-explosive liquids containing no fibre
- Convey solids up to Ø4 mm
- Industrial and chemical processes
- Sea water
- Water treatment
- Food industry (milk, fruit juices, saltwater)
- Light oil
- Chiller and circulation systems

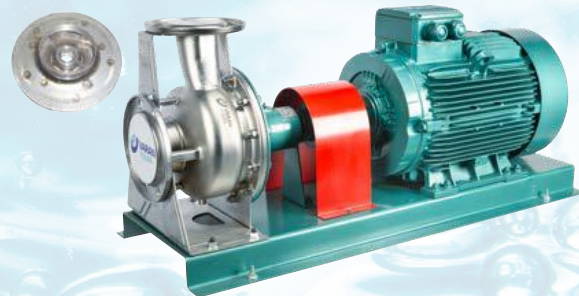

CY (1500 d/d)

KOMPLE PASLANMAZ ÇELİK (AISI 316) KAPLINLİ SANTRİFÜJ POMPALAR

STAINLESS STEEL(AISI 316) CENTRIFUGAL PUMPS

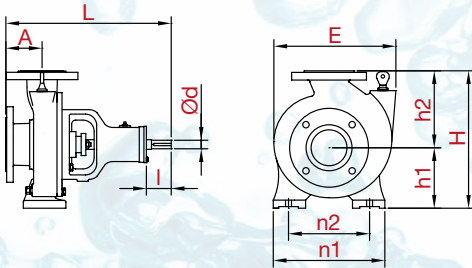
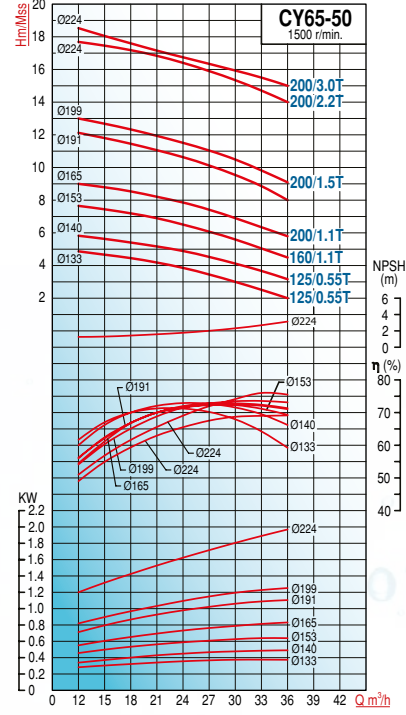
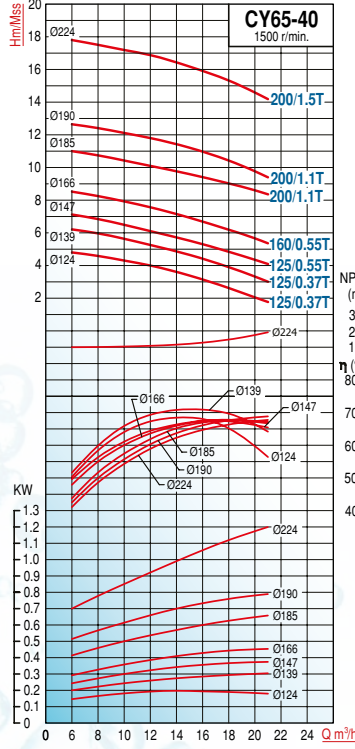
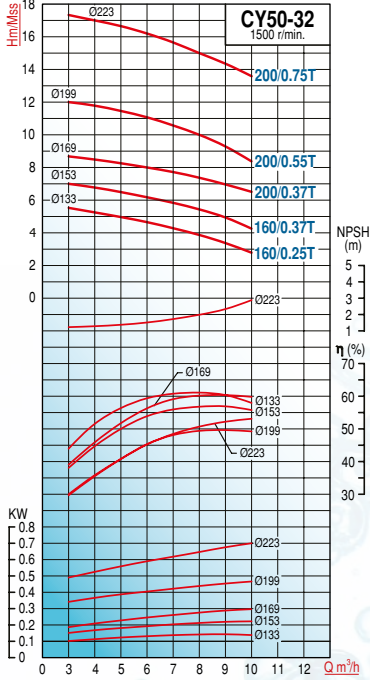

TİP TYPE	Boyutlar - Dimensions (mm)										Tek Pompa	
	A	L	h1	h2	H	E	n1	n2	i	d	Ağırlık - Weight (kg)	
CY50-32-160/0.25T	80	359	112	143	246	210	190	160	71	22	18	
CY50-32-160/0.37T	80	359	112	143	246	210	190	160	71	22	18	
CY50-32-200/0.37T	80	353	160	180	279	300	240	190	62	22	27	
CY50-32-200/0.55T	80	353	160	180	302	300	240	190	62	22	27	
CY50-32-200/0.75T	80	353	160	180	322	300	240	190	62	22	27	
CY65-40-125/0.37T	80	359	112	143	255	210	190	160	71	22	18	
CY65-40-125/0.37T	80	359	112	143	255	210	190	160	71	22	18	
CY65-40-125/0.55T	80	352	132	160	292	250	240	190	71	22	22	
CY65-40-160/0.55T	80	352	132	142	292	250	240	190	71	22	22	
CY65-40-200/1.1T	100	375	160	200	322	300	264	212	62	22	28	
CY65-40-200/1.1T	100	375	160	200	322	300	264	212	62	22	28	
CY65-40-200/1.5T	100	375	160	200	339	300	264	212	62	22	28	
CY65-50-125/0.55T	80	352	132	160	295	260	240	190	71	22	23	
CY65-50-125/0.55T	80	352	132	160	295	260	240	190	71	22	23	
CY65-50-160/1.1T	100	375	160	200	360	300	264	212	62	22	28	
CY65-50-200/1.1T	100	375	160	200	360	300	264	212	62	22	28	
CY65-50-200/1.5T	100	375	160	200	360	300	264	212	62	22	28	
CY65-50-200/1.5T	100	375	160	200	360	300	264	212	62	22	28	
CY65-50-200/2.2T	100	375	160	200	360	300	264	212	62	22	28	
CY65-50-200/3.0T	100	375	160	200	360	350	264	212	62	22	28	

CY (1500 d/d)

KOMPLE PASLANMAZ ÇELİK (AISI 316) KAPLINLİ SANTRİFÜJ POMPALAR

STAINLESS STEEL(AISI 316) CENTRIFUGAL PUMPS

TİP TYPE	Bağlantı Giriş x Çıkış Inlet x Outlet	MOTOR				m ³ /h	Debi (Q) - Capacity								FİYAT - PRICE (USD)	
		HP	kW	V	A		21	24	30	39	48	57	66	72	Pompa & Mot. Akuple Pump & Mot. Coupled	
CY80-65-125/0.55T	3"x 2½"	0,75	0,55	080	1,45	4,6	4,4	4	3,2	2,3	1,4				\$1.620	
CY80-65-125/0.75T		1	0,75		1,95	5,8	5,7	5,2	4,4	3,5	2,5				\$1.680	
CY80-65-125/1.1T		1,5	1,1		2,6	7	6,7	6,3	5,4	4,5	3,5				\$1.730	
CY80-65-125/1.1T		1,5	1,1		2,6	8,1	7,9	7,4	6,3	5,7	4,6				\$1.810	
CY80-65-160/1.5T		2	1,5		3,4	9,2	9	8,5	7,7	6,7	5,7	4,5			\$1.935	
CY80-65-160/2.2T		3	2,2		4,85	11,3	11,1	10,6	9,8	8,8	7,6	6,4	5,5		\$2.010	
CY80-65-200/3.0T		4	3		6,42	12,4	12,4	11,6	10,6	9,5	8,4	7,2	6,3		\$2.095	
CY80-65-200/4.0T		5,5	4		8,2	15	14,8	14,5	14	12,9	11,6	10,1	9		\$2.215	
CY80-65-200/5.5T		7,5	5,5		11,2	18	17,8	17,6	17,1	16,5	15,7	14,5	12		\$2.345	

Flanşlar hariçtir. Takım fiyatı: 140 USD

TİP TYPE	Bağlantı Giriş x Çıkış Inlet x Outlet	MOTOR				m ³ /h	Debi (Q) - Capacity								FİYAT - PRICE (USD)	
		HP	kW	V	A		30	36	60	72	84	96	100	108	Pompa & Mot. Akuple Pump & Mot. Coupled	
CY100-80-160/1.5T	4" x 3"	2	1,5	380	3,4	7	6,8	5,7	5	4,2	3,4	3	2,4		\$1.920	
CY100-80-160/2.2T		3	2,2		4,85	8,7	8,4	7,3	6,7	6	5,2	4,9	4,2		\$2.010	
CY100-80-160/3.0T		4	3		6,42	9,5	9,3	8,3	7,8	7,1	6,2	5,9	5,2		\$2.075	
CY100-80-200/3.0T		4	3		6,42	12,4	12,1	10,7	9,7	8,6	7,3	6,9	5,9		\$2.200	
CY100-80-200/5.5T		7,5	5,5		11,2	14,5	14,3	13,2	12,2	11,2	10,1	9,5	8,8		\$2.470	
CY100-80-200/5.5T		7,5	5,5		11,2	16,5	16,1	14,4	13,5	12,5	11,3	10,9	9,9		\$2.470	

Flanşlar hariçtir. Takım fiyatı: 160 USD

TEKNİK ÖZELLİKLER

- Çark: Paslanmaz çelik (AISI 316)
- Partikül büyüklüğü max. Ø18 mm
- Gövde: Paslanmaz Çelik (AISI 316)
- Mil: Paslanmaz çelik (AISI 316)
- Mekanik salmastra (Karbon/Seramik/Viton) Ø25-Ø30
- Çalışma sıcaklığı: +5°C ~ +90°C
- Devir Hızı: 2900d/dak.
- Koruma sınıfı: IP55
- İzalasyon sınıfı: F
- Emme derinliği: 6.5mt.

TECHNICAL DATA

- Impeller: S/S (AISI 316)
- Solids up to Ø4 mm
- Pump Body: S/S (AISI 316)
- Shaft: S/S (AISI 316)
- Non-Leakage: Mechanical seal (Carbon/Ceramic/Viton) Ø25-Ø30
- Liquid Temp.: +5°C ~ +90°C
- Speed: 2900 rpm.
- Protection Class: IP55
- Insulation Class: F
- Suction lift: Max 6.5 m.

KULLANIM ALANLARI

- İçme suyu, maden suyu, saf su
- Yanıcı ve Patlayıcı içermeyen temiz ve lifsiz sıvılar.
- Max. Ø4 mm partiküllü sıvılar
- Endüstriyel ve kimyasal prosesler
- Deniz suyu
- Arıtma tesisleri
- Gıda sanayi (Süt, Meyve ve Salamura Suyu vs.)
- Hafif yağlar
- Soğutma ve sirkülasyon sistemleri

APPLICATIONS

- Drinking water, mineral and pure water, Non-flammable, non-explosive liquids containing no fibre
- Convey solids up to Ø4 mm
- Industrial and chemical processes
- Sea water
- Water treatment
- Food industry (milk, fruit juices, saltwater)
- Light oil
- Chiller and circulation systems

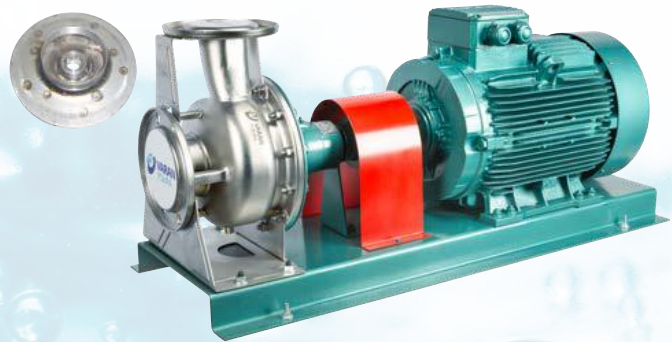

CY (1500 d/d)

KOMPLE PASLANMAZ ÇELİK (AISI 316) KAPLINLİ SANTRİFÜJ POMPALAR

STAINLESS STEEL(AISI 316) CENTRIFUGAL PUMPS

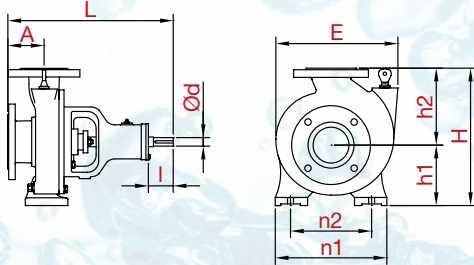
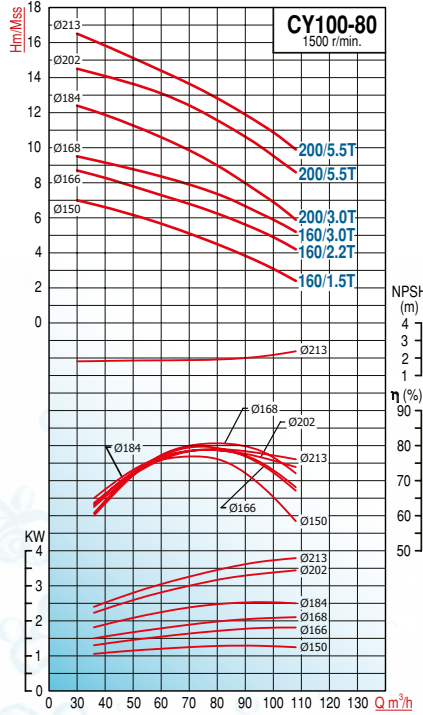
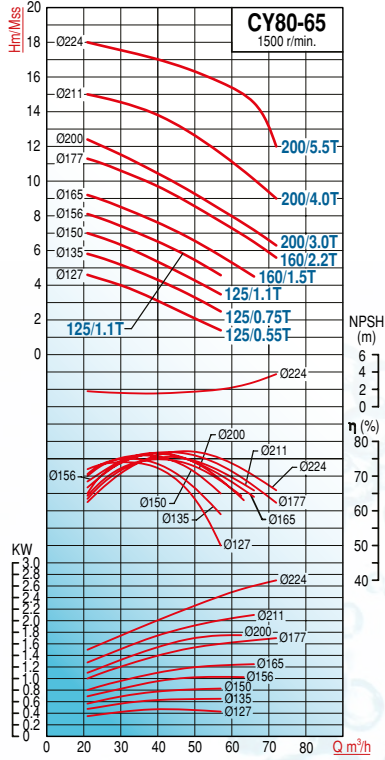

TİP TYPE	Boyutlar - Dimensions (mm)										Tek Pompa
	A	L	h1	h2	H	E	n1	n2	ı	d	Ağırlık - Weight (kg)
CY80-65-125/0.55T	100	377	160	180	340	256	250	212	71	22	24
CY80-65-125/0.75T	100	377	160	180	340	256	250	212	71	22	24
CY80-65-125/1.1T	100	377	160	180	340	256	250	212	71	22	24
CY80-65-125/1.1T	100	377	160	180	340	256	250	212	71	22	24
CY80-65-160/1.5T	100	377	160	200	360	300	250	212	62	22	29
CY80-65-160/2.2T	100	377	160	200	360	300	250	212	62	22	29
CY80-65-200/3.0T	100	376	180	225	405	300	290	250	62	22	29
CY80-65-200/4.0T	100	376	180	225	405	300	290	250	62	22	29
CY80-65-200/5.5T	100	376	180	225	405	300	290	250	62	22	30
CY100-80-160/1.5T	125	407	180	225	405	256	290	250	71	22	26
CY100-80-160/2.2T	125	407	180	225	405	256	290	250	71	22	26
CY100-80-160/3.0T	125	407	180	225	405	256	290	250	71	22	26
CY100-80-200/3.0T	125	412	180	250	430	300	320	280	62	22	31
CY100-80-200/5.5T	125	412	200	250	450	300	320	280	62	22	31
CY100-80-200/5.5T	125	412	200	250	450	300	320	280	62	22	31

CMF

KOMPLE PASLANMAZ ÇELİK (AISI 316) KADEMELİ POMPALAR

STAINLESS STEEL(AISI 316) MULTI-STAGE PUMPS

TİP TYPE	Bağlantı		MOTOR				Kademe Stage	m ³ /h	Debi (Q) - Capacity						FİYAT PRICE (USD)		
	Giriş x Çıkış		HP	kW	V				A		2	5	7	10		15	30
	Inlet	Outlet			Mono	Tri			Mono	Tri							
CMF4-40	1 1/4" x 1"		1	0.75	220	380	5.2	1.9	Hm (mSS)	38	25	16	3			\$365	
CMF8-20	1.5" x 1.5"		1.5	1.1	220	380	6.2	2.4		2	34	28	23	15			\$435
CMF12-25	1.5" x 1.5"		3	2.2	220	380	14	5.2		3	50	48	45	40	30		\$580
CMF16-30	2" x 2"		3	2.2	-	380	-	5.2		3	40	39	38	36	31	9	\$665

TEKNİK ÖZELLİKLER

- Çark: Paslanmaz Çelik (AISI 316)
- Difüzör: Paslanmaz Çelik (AISI 316)
- Gövde: Paslanmaz Çelik (AISI 316)
- Mil: Paslanmaz Çelik (AISI 316)
- Sızdırmazlık: Mekanik salmastra (Karbon/Seramik/Viton) (CMF4): Ø16 (CMF8, CMF12, CMF16): Ø19
- Sıvı sıcaklığı: +5°C ~ +90°C
- Devir Hızı: 2900d/dak.
- Koruma sınıfı: IP 55
- İzolasyon sınıfı: F
- Emme derinliği: 6.5mt.

TECHNICAL DATA

- Impeller: S/S (AISI 316)
- Diffuser: S/S (AISI 316)
- Pump Body: S/S (AISI 316)
- Shaft: S/S (AISI 316)
- Non-Leakage: Mechanical seal (Carbon/Ceramic/Viton) (CMF4): Ø16 (CMF8, CMF12, CMF16): Ø19
- Liquid Temp.: +5°C ~ +90°C
- Speed: 2900 rpm.
- Protection Class: IP55
- Insulation Class: F
- Suction lift: Max 6.5 m.



KULLANIM ALANLARI

- İçme suyu, maden suyu, saf su Yanıcı ve Patlayıcı içermeyen temiz ve lifsiz sular
- Endüstriyel ve kimyasal prosesler
- Deniz suyu
- Arıtma tesisleri
- Gıda sanayi (Süt, Meyve ve Salamura Suyu vs.)
- Hafif yağlar
- Hidrofor sistemleri
- Soğutma sistemleri

APPLICATIONS

- Drinking water, mineral and pure water, Non-flammable, non-explosive liquids containing no granules and fibre
- Industrial and chemical processes
- Sea water
- Water treatment
- Food industry (milk, fruit juices, saltwater)
- Light oil
- Booster systems
- Chiller systems

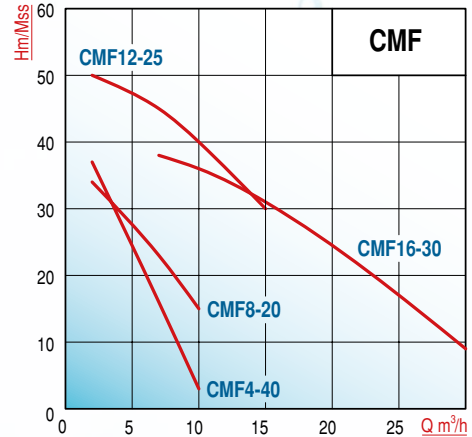
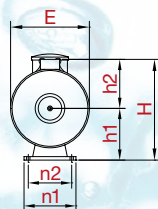
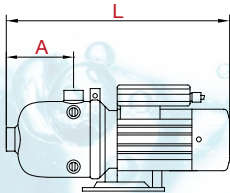

TİP TYPE	Boyutlar - Dimensions (mm)								Ağırlık - Weight Kg
	A	L	h1	h2	H	E	n1	n2	
CMF4-40	130	400	110	98	230	165	130	108	12
CMF8-20	138	420	120	122	250	204	130	108	14
CMF12-25	138	510	120	122	261	204	130	108	18
CMF16-30	162	520	120	122	261	205	130	108	23

CM

KOMPLE PASLANMAZ ÇELİK (AISI 316) KADEMELİ POMPALAR

STAINLESS STEEL(AISI 316) MULTI-STAGE PUMPS

TİP TYPE	Bağlantı		MOTOR				Kademe Stage	Hm m ³ /h (mss)	Debi (Q) - Capacity						FİYAT-PRICE (USD)
	Giriş x Çıkış Inlet x Outlet	HP	kW	V		A			1	3	4	5	7	10	
				Mono	Tri	Mono	Tri								
CM4-60T	1 1/4" x 1"	1,5	1,1	-	380	-	2,4	6	56	51	46	41	26		\$460
CM8-40T	1.5" x 1.5"	3	2,2	-	380	-	5,2	4	73	67	64	60	52	36	\$730

TEKNİK ÖZELLİKLER

- Çark: Paslanmaz Çelik (AISI 316)
- Difüzör: Paslanmaz Çelik (AISI 316)
- Gövde: Paslanmaz Çelik (AISI 316)
- Mil: Paslanmaz Çelik (AISI 316)
- Sızdırmazlık: Mekanik salmastra (Karbon/Seramik/Viton) (CM4): Ø16, (CM8): Ø19
- Sıvı sıcaklığı: +5°C ~ +90°C
- Devir Hızı: 2900d/dak.
- Koruma sınıfı: IP 55
- İzolasyon sınıfı: F
- Emme derinliği: 6.5mt.

TECHNICAL DATA

- Impeller: S/S (AISI 316)
- Diffuser: S/S (AISI 316)
- Pump Body: S/S (AISI 316)
- Shaft: S/S (AISI 316)
- Non-Leakage: Mechanical seal (Carbon/Ceramic/Viton) (CM4): Ø16, (CM8): Ø19
- Liquid Temp.: +5°C ~ +90°C
- Speed: 2900 rpm.
- Protection Class: IP55
- Insulation Class: F
- Suction lift: Max 6.5 m.



CM4

**AISI
316**



CM8

KULLANIM ALANLARI

- İçme suyu, maden suyu, saf su
- Yanıcı ve Patlayıcı içermeyen temiz ve lıfızlı sular
- Endüstriyel ve kimyasal prosesler
- Deniz suyu
- Arıtma tesisleri
- Gıda sanayi (Süt, Meyve ve Salmura Suyu vs.)
- Hafif yağlar
- Hidrofor sistemleri
- Soğutma sistemleri

APPLICATIONS

- Drinking water, mineral and pure water, Non-flammable, non-explosive liquids containing no granules and fibre
- Industrial and chemical processes
- Sea water
- Water treatment
- Food industry (milk, fruit juices, saltwater)
- Light oil
- Booster systems
- Chiller systems

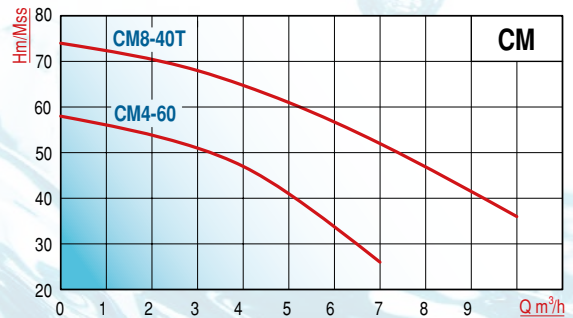
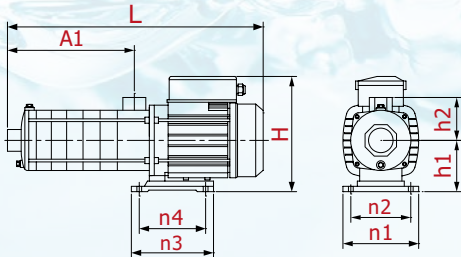

TİP TYPE	Boyutlar - Dimensions (mm)										Ağırlık - Weight Kg
	A	L	h1	h2	H	n1	n2	n3	n4		
CM4-60	217	443	90	72	162	133	108	180	138	11	
CM4-60T	217	443	90	72	162	133	108	180	138	11	
CM8-40T	168	480	118	110	228	130	108	180	138	26	

CMI

KOMPLE PASLANMAZ ÇELİK (AISI 304) KADEMELİ POMPALAR

STAINLESS STEEL(AISI 304) MULTI-STAGE PUMPS

TİP TYPE	Bağlantı	MOTOR						Kademe Stage	m ³ /h	Debi (Q) - Capacity						FİYAT/PRICE (USD)	
	Giriş x Çıkış Inlet x Outlet	HP	kW	V		A				1	2	4	6	8	10	14	220V
CMI4-5	1¼" x 1"	1	0,75	220	380	5,2	1,9	5	Hm (mSS)	48	46	38	23			\$300	\$265
CMI4-7	1¼" x 1"	2	1,5	220	380	7	3,5	7		67	64	55	38			\$370	\$395
CMI8-30	1½" x 1½"	2,5	1,85	220	380	13	4,1	3		55	54	50	44	32	26	\$575	\$495
CMI8-40T	1½" x 1½"	3	2,2	-	380	-	5,2	4		68	67	65	57	43	34		\$525
CMI10-5T	1½" x 1½"	4	3	-	380	-	6,5	5		77,5	77	76,5	75	71	63	46	

TEKNİK ÖZELLİKLER

- Çark: Paslanmaz Çelik (AISI 304)
- Difüzör: Paslanmaz Çelik (AISI 304)
- Gömlek: Paslanmaz Çelik (AISI 304)
- Mil: Paslanmaz Çelik (AISI 304)
- Sızdırmazlık: Mekanik salmastra (Karbon/Sic/Viton)
- Sıvı sıcaklığı: +5°C ~ +90°C
- Devir Hızı: 2900d/dak.
- Koruma sınıfı: IP 55
- İzolasyon sınıfı: F
- Emme derinliği: 6.5mt.

TECHNICAL DATA

- Impeller: S/S (AISI 304)
- Diffuser: S/S (AISI 304)
- Pump Body: Cast iron GG-25
- Shaft: S/S (AISI 304)
- Non-Leakage: Mechanical seal (Carbon/Sic/Viton)
- Liquid Temp.: +5°C ~ +90°C
- Speed: 2900 rpm.
- Protection Class: IP55
- Insulation Class: F
- Suction lift: Max 6.5 m.



KULLANIM ALANLARI

- İçme suyu, maden suyu, saf su Yanıcı ve Patlayıcı içermeyen temiz ve lifsiz sular
- Endüstriyel ve kimyasal prosesler
- Arıtma tesisleri
- Gıda sanayi
- Hafif yağlar
- Hidrofor sistemleri
- Soğutma sistemleri

APPLICATIONS

- Drinking water, mineral and pure water, Non-flammable, non-explosive liquids containing no granules and fibre
- Industrial and chemical processes
- Water treatment
- Food industry
- Light oil
- Booster systems
- Chiller systems

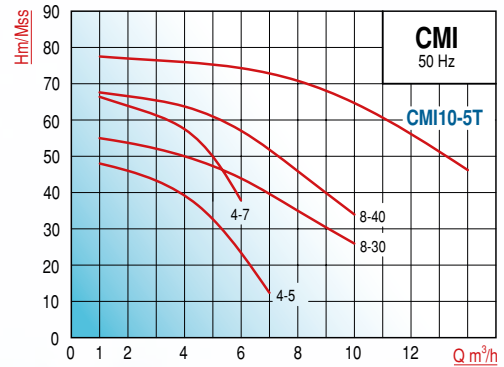
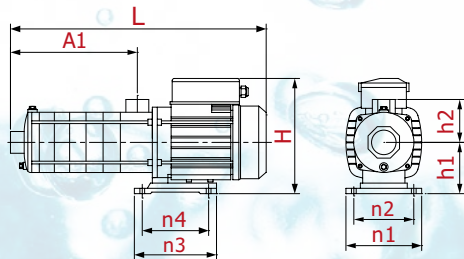

TİP TYPE	Boyutlar - Dimensions (mm)									Ağırlık - Weight
	A	L	h1	h2	H	n1	n2	n3	n4	Kg
CMI4-5	104	378	75	86	188	158	125	155	96	12,5
CMI4-7	140	414	75	86	188	158	125	155	96	15
CMI8-30T	100	408	100	108	217	158	125	136	96	21
CMI8-40T	130	438	100	108	217	158	125	138	96	23
CMI10-5T	190	558	100	108	212	199	160	172	140	26

CVL

KOMPLE PASLANMAZ ÇELİK (AISI 304) KADEMELİ POMPALAR

STAINLESS STEEL(AISI 304) MULTI-STAGE PUMPS

TİP TYPE	Bağlantı		MOTOR				KADEME STAGE	m ³ /h	Debi (Q) - Capacity						FİYAT - PRICE (USD)	
	Giriş x Çıkış		HP	kW	V	A			Pompa + Mot. Akuple							
	Inlet x Outlet								Pump + Mot. Coupled							
CVL3-10	1 ¼" x 1 ¼"		1	0,75	380	1,6	10	Hm (mSS)	1	2	2,5	3	3,5	4	\$770	
CVL3-12	1 ¼" x 1 ¼"		1,5	1,1	380	2,5	12		60	55	50	43	36	28	\$805	
CVL3-15	1 ¼" x 1 ¼"		1,5	1,1	380	2,5	15		72	66	59	52	44	34	\$850	
CVL3-19	1 ¼" x 1 ¼"		2	1,5	380	3	19		90	82	77	69	60	44	\$995	
CVL3-29	1 ¼" x 1 ¼"		3	2,2	380	4,5	29		113	104	98	88	77	58	\$1.225	
									170	156	147	132	118	93		

Flanşlar hariçtir. Takım fiyatı: 80 USD

TİP TYPE	Bağlantı		MOTOR				KADEME STAGE	m ³ /h	Debi (Q) - Capacity						FİYAT - PRICE (USD)	
	Giriş x Çıkış		HP	kW	V	A			Pompa + Mot. Akuple							
	Inlet x Outlet								Pump + Mot. Coupled							
CVL5-10	1 ¼" x 1 ¼"		2	1,6	380	3	10	Hm (mSS)	2	3	4	5	6,5	8	\$905	
CVL5-12	1 ¼" x 1 ¼"		3	2,2	380	4,5	12		62	59	55	50	41	30	\$975	
CVL5-16	1 ¼" x 1 ¼"		3	2,2	380	4,5	16		75	73	68	62	49	36	\$1.070	
CVL5-20	1 ¼" x 1 ¼"		4	3	380	6	20		103	100	94	85	69	48	\$1.250	
CVL5-29	1 ¼" x 1 ¼"		5,5	4	380	7,8	29		129	122	115	105	86	60	\$1.590	
									185	177	168	157	132	87		

Flanşlar hariçtir. Takım fiyatı: 80 USD

TİP TYPE	Bağlantı		MOTOR				KADEME STAGE	m ³ /h	Debi (Q) - Capacity						FİYAT - PRICE (USD)	
	Giriş x Çıkış		HP	kW	V	A			Pompa + Mot. Akuple							
	Inlet x Outlet								Pump + Mot. Coupled							
CVL10-6	1½" x 1½"		3	2,2	380		6	Hm (mSS)	2	6	8	10	12	14	\$1.130	
CVL10-7	1½" x 1½"		4	3	380	6	7		62	58	53	46	38	28	\$1.230	
CVL10-9	1½" x 1½"		4	3	380	6	9		73	67	61	54	43	32	\$1.335	
CVL10-12	1½" x 1½"		5,5	4	380	7,8	12		93	87	81	71	59	42	\$1.545	
CVL10-16	1½" x 1½"		7,5	5,5	380	10,3	16		123	117	108	95	78	55	\$1.980	
									163	154	143	125	102	71		

Flanşlar hariçtir. Takım fiyatı: 105 USD

TİP TYPE	Bağlantı		MOTOR				KADEME STAGE	m ³ /h	Debi (Q) - Capacity						FİYAT - PRICE (USD)	
	Giriş x Çıkış		HP	kW	V	A			Pompa + Mot. Akuple							
	Inlet x Outlet								Pump + Mot. Coupled							
CVL15-5	2" x 2"		5,5	4	380	7,8	5	Hm (mSS)	8	12	15	18	20	24	\$1.355	
CVL15-7	2" x 2"		7,5	5,5	380	10,3	7		66	61	56	50	45	33	\$1.745	
CVL15-9	2" x 2"		10	7,5	380	14,1	9		94	88	80	71	64	50	\$1.910	
CVL15-12	2" x 2"		15	11	380	20,5	12		122	115	106	95	87	66	\$2.710	
CVL15-14	2" x 2"		15	11	380	20,5	14		158	150	140	126	116	89	\$2.810	
									183	172	162	145	133	103		

Flanşlar hariçtir. Takım fiyatı: 105 USD

TİP TYPE	Bağlantı		MOTOR				KADEME STAGE	m ³ /h	Debi (Q) - Capacity						FİYAT - PRICE (USD)	
	Giriş x Çıkış		HP	kW	V	A			Pompa + Mot. Akuple							
	Inlet x Outlet								Pump + Mot. Coupled							
CVL20-5	2" x 2"		7,5	5,5	380	10,3	5	Hm (mSS)	8	12	16	20	24	28	\$1.610	
CVL20-7	2" x 2"		10	7,5	380	14,1	7		68	65	61	55	45	33	\$1.815	
CVL20-10	2" x 2"		15	11	380	20,5	10		96	92	86	77	65	47	\$2.580	
CVL20-14	2" x 2"		20	15	380	28	14		137	132	124	112	98	73	\$2.935	
									191	186	176	161	140	110		

Flanşlar hariçtir. Takım fiyatı: 105 USD

TEKNİK ÖZELLİKLER

- Çark: Paslanmaz Çelik (AISI 304)
- Difüzör: Paslanmaz Çelik (AISI 304)
- Gövde: Paslanmaz Çelik (AISI 304)
- Mil: Paslanmaz Çelik (AISI 304)
- Sızdırmazlık: Mekanik salmastra (Karbon/Silisyum/Viton)
- Sıvı sıcaklığı: +5°C ~ +90°C
- Devir Hızı: 2900d/dak.
- Koruma sınıfı: IP 55
- İzolasyon sınıfı: F
- Emme derinliği: 6.5mtr.

TECHNICAL DATA

- Impeller: S/S (AISI 304)
- Diffuser: S/S (AISI 304)
- Pump Body: S/S (AISI 304)
- Shaft: S/S (AISI 304)
- Non-Leakage: Mechanical seal (Carbon/Silicon/Viton)
- Liquid Temp.: +5°C ~ +90°C
- Speed: 2900 rpm.
- Protection Class: IP55
- Insulation Class: F
- Suction lift: Max 6.5 m.

KULLANIM ALANLARI

- İçme suyu, maden suyu, saf su, yanıcı ve patlayıcı içermeyen temiz ve lifsiz sular
- Endüstriyel ve kimyasal prosesler
- Arıtma tesisleri
- Gıda sanayi (Süt, Meyve ve Salamura Suyu vs.)
- Hafif yağlar
- Hidrofor sistemleri
- Soğutma sistemleri

APPLICATIONS

- Drinking water, mineral and pure water, Non-flammable, non-explosive liquids containing no granules and fibre
- Industrial and chemical processes
- Water treatment
- Food industry (milk, fruit juices, salt-water)
- Light oil
- Booster systems
- Chiller systems

CVL
KOMPLE PASLANMAZ ÇELİK (AISI 304) KADEMELİ POMPALAR

STAINLESS STEEL(AISI 304) MULTI-STAGE PUMPS

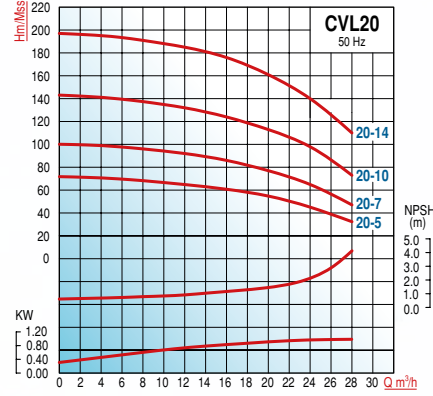
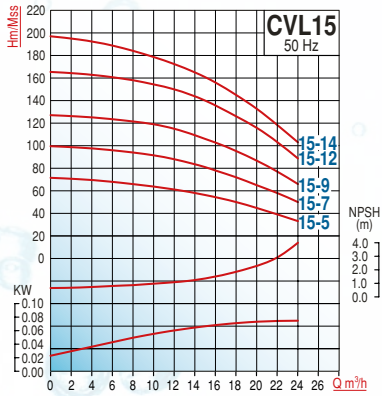
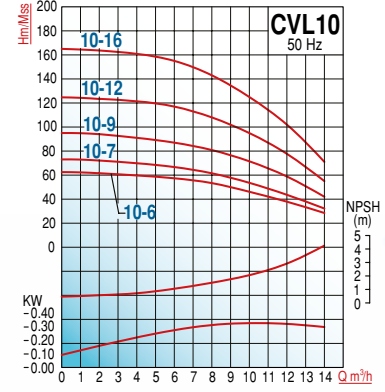
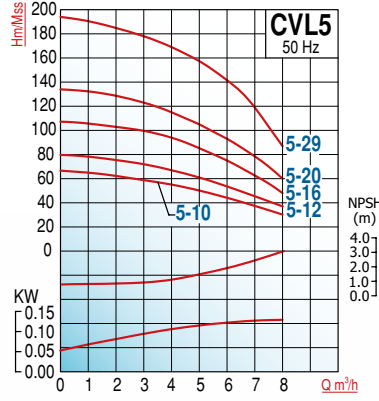
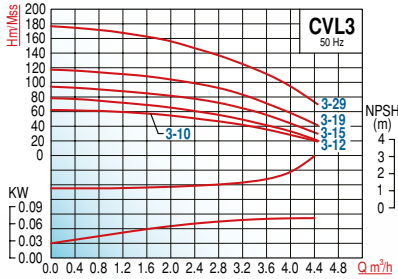

TİP TYPE	Boyutlar - Dimensions (mm)										
	h	H	DN	k1	k2	L	n1	n2	n3	n4	Ød
CVL3-10	75	416	32	125	125	250	150	100	213	180	13
CVL3-12	75	445	32	125	125	250	150	100	213	180	13
CVL3-15	75	514	32	125	125	250	150	100	213	180	13
CVL3-19	75	596	32	125	125	250	150	100	213	180	13
CVL3-29	75	776	32	125	125	250	150	100	213	180	13
CVL5-10	75	524	32	125	125	250	150	100	213	180	13
CVL5-12	75	561	32	125	125	250	150	100	213	180	13
CVL5-16	75	686	32	125	125	250	150	100	213	180	13
CVL5-20	75	794	32	125	125	250	150	100	213	180	13
CVL5-29	75	1052	32	125	125	250	150	100	213	180	13
CVL10-6	90	496	40	140	140	280	200	130	248	215	13,5
CVL10-7	90	513	40	140	140	280	200	130	248	215	13,5
CVL10-9	90	586	40	140	140	280	200	130	248	215	13,5
CVL10-12	90	691	40	140	140	280	200	130	248	215	13,5
CVL10-16	90	833	40	140	140	280	200	130	248	215	13,5
CVL15-5	90	558	50	150	150	300	200	130	248	215	13,5
CVL15-7	90	668	50	150	150	300	200	130	248	215	13,5
CVL15-9	90	758	50	150	150	300	200	130	248	215	13,5
CVL15-12	90	921	50	150	150	300	200	130	248	215	13,5
CVL15-14	90	1011	50	150	150	300	200	130	248	215	13,5
CVL20-5	90	582	50	150	150	300	200	130	248	215	13,5
CVL20-7	90	668	50	150	150	300	200	130	248	215	13,5
CVL20-10	90	830	50	150	150	300	200	130	248	215	13,5
CVL20-14	90	1011	50	150	150	300	200	130	248	215	13,5

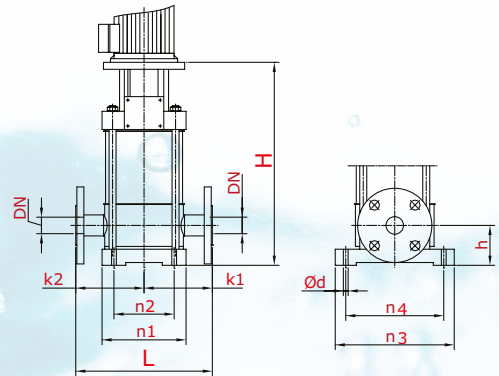

CVF

KOMPLE PASLANMAZ ÇELİK (AISI 304) KADEMELİ POMPALAR

STAINLESS STEEL(AISI 304) MULTI-STAGE PUMPS

TİP TYPE	Bağlantı		MOTOR				KADEME	m ³ /h	Debi (Q) - Capacity						FİYAT - PRICE (USD)	
	Giriş x Çıkış	Inlet x Outlet	HP	kW	V	A			STAGE	Debi (Q) - Capacity						Pompa + Mot. Akuple
	12						20			24	30	36	40	Pump + Mot. Coupled		
CVF32-4	2½" x 2½"	10	7,5	380/360	13,6	4	Hm (mss)	72	66	62	53	42	34	\$2.140		
CVF32-5	2½" x 2½"	15	11		19,6	5		91	83	78	66	53	42	\$2.935		
CVF32-6	2½" x 2½"	15	11		20,5	6		109	101	95	83	65	52	\$3.045		
CVF32-8	2½" x 2½"	20	15		26,7	8		143	134	126	111	88	70	\$3.440		
CVF32-10	2½" x 2½"	25	18,5		32,6	10		179	169	162	142	114	88	\$3.820		
CVF32-12	2½" x 2½"	30	22		39,2	12		214	203	194	171	137	107	\$4.585		

Flanşlar hariçtir. Takım fiyatı: 130 USD

TİP TYPE	Bağlantı		MOTOR				KADEME	m ³ /h	Debi (Q) - Capacity						FİYAT - PRICE (USD)	
	Giriş x Çıkış	Inlet x Outlet	HP	kW	V	A			STAGE	Debi (Q) - Capacity						Pompa + Mot. Akuple
	25						30			35	45	50	55	Pump + Mot. Coupled		
CVF45-3	3" x 3"	15	11	380/360	19,6	3	Hm (mss)	72	70	67	58	53	45	\$2.840		
CVF45-4	3" x 3"	20	15		26,9	4		98	94	87	77	70	61	\$3.090		
CVF45-5	3" x 3"	25	18,5		32,6	5		123	118	112	97	88	77	\$3.385		
CVF45-6	3" x 3"	30	22		39,2	6		147	141	135	118	107	94	\$4.055		
CVF45-9-2	3" x 3"	40	30		54,6	9		209	202	193	169	152	133	\$5.395		

Flanşlar hariçtir. Takım fiyatı: 145 USD

TİP TYPE	Bağlantı		MOTOR				KADEME	m ³ /h	Debi (Q) - Capacity						FİYAT - PRICE (USD)	
	Giriş x Çıkış	Inlet x Outlet	HP	kW	V	A			STAGE	Debi (Q) - Capacity						Pompa + Mot. Akuple
	30						40			50	64	70	80	Pump + Mot. Coupled		
CVF64-3-1	4" x 4"	20	15,0	380/360	26,9	3	Hm (mss)	73	69	63	53	48	39	\$3.030		
CVF64-4-2	4" x 4"	25	18,5		32,6	4		92	87	80	66	60	49	\$3.325		
CVF64-4	4" x 4"	30	22		39,2	4		107	101	94	80	74	61	\$3.875		
CVF64-6-2	4" x 4"	40	30		54,6	6		147	140	130	112	101	81	\$5.045		

Flanşlar hariçtir. Takım fiyatı: 175 USD

TİP TYPE	Bağlantı		MOTOR				KADEME	m ³ /h	Debi (Q) - Capacity						FİYAT - PRICE (USD)	
	Giriş x Çıkış	Inlet x Outlet	HP	kW	V	A			STAGE	Debi (Q) - Capacity						Pompa + Mot. Akuple
	50						70			80	90	100	110	Pump + Mot. Coupled		
CVF90-2	4" x 4"	20	15,0	380 / 660	26,9	2	Hm (mss)	56	49	45	40	35	30	\$3.075		
CVF90-3-2	4" x 4"	25	18,5		32,6	3		68	60	55	49	41	33	\$3.465		
CVF90-3	4" x 4"	30	22		39,2	3		83	73	67	61	54	47	\$3.840		
CVF90-4-2	4" x 4"	40	30		54,6	4		98	87	80	72	62	50	\$4.890		

Flanşlar hariçtir. Takım fiyatı: 175 USD

TEKNİK ÖZELLİKLER

- Çark: Paslanmaz Çelik (AISI 304)
- Difüzör: Paslanmaz Çelik (AISI 304)
- Gövde: Döküm Paslanmaz Çelik (AISI 304)
- Mil: Paslanmaz Çelik (AISI 304)
- Sızdırmazlık: Mekanik salmastra (Karbon/Silisyum/Viton)
- Sıvı sıcaklığı: +5°C ~ +90°C
- Devir Hızı: 2900d/dak.
- Koruma sınıfı: IP 55
- İzolasyon sınıfı: F
- Emme derinliği: 6.5mt.

KULLANIM ALANLARI

- İçme suyu, maden suyu, saf su, yanıcı ve patlayıcı içermeyen temiz ve lifsiz sular
- Endüstriyel ve kimyasal prosesler
- Arıtma tesisleri
- Gıda sanayi (Süt, Meyve ve Salamura Suyu vs.)
- Hafif yağlar
- Hidrofor sistemleri
- Soğutma sistemleri

TECHNICAL DATA

- Impeller: S/S (AISI 304)
- Diffuser: S/S (AISI 304)
- Pump Body: S/S (AISI 304)
- Shaft: S/S (AISI 304)
- Non-Leakage: Mechanical seal (Carbon/Silicon/Viton)
- Liquid Temp.: +5°C ~ +90°C
- Speed: 2900 rpm.
- Protection Class: IP55
- Insulation class: F
- Suction lift: Max 6.5 m.

APPLICATIONS

- Drinking water, mineral and pure water, Non-flammable, non-explosive liquids containing no granules and fibre
- Industrial and chemical processes
- Water treatment
- Food industry (milk, fruit juices, saltwater)
- Light oil
- Booster systems
- Chiller systems



CVF
KOMPLE PASLANMAZ ÇELİK (AISI 304) KADEMELİ POMPALAR

STAINLESS STEEL(AISI 304) MULTI-STAGE PUMPS

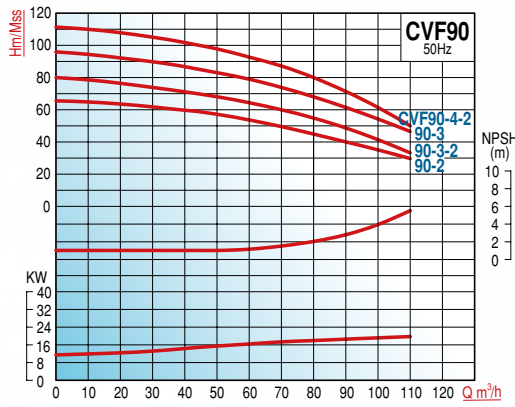
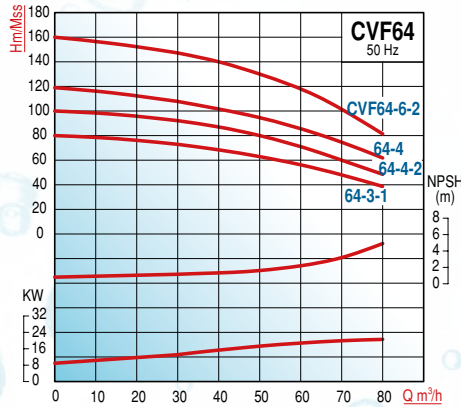
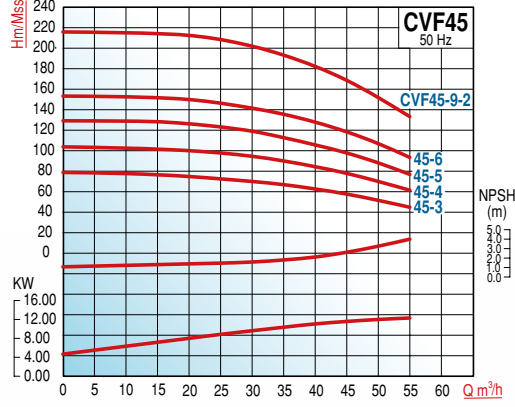
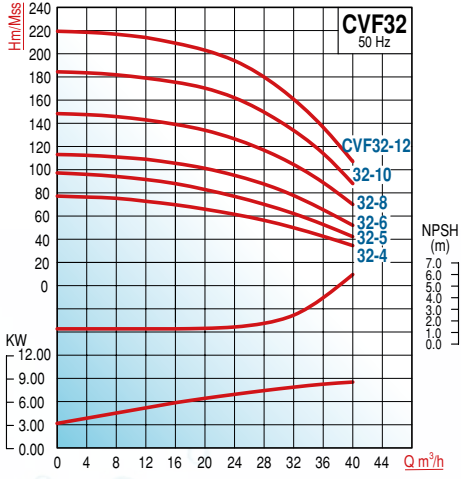

TİP TYPE	Boyutlar - Dimensions (mm)										
	h	H	DN	k1	k2	L	n1	n2	n3	n4	Ød
CVF32-4	105	690	65	160	160	320	226	170	298	240	14
CVF32-5	105	915	65	160	160	320	226	170	298	240	14
CVF32-6	105	985	65	160	160	320	226	170	298	240	14
CVF32-8	105	1125	65	160	160	320	226	170	298	240	14
CVF32-10	105	1265	65	160	160	320	226	170	298	240	14
CVF32-12	105	1405	65	160	160	320	226	170	298	240	14
CVF45-3	140	826	80	182,5	182,5	365	251	190	331	266	14
CVF45-4	140	906	80	182,5	182,5	365	251	190	331	266	14
CVF45-5	140	986	80	182,5	182,5	365	251	190	331	266	14
CVF45-6	140	1066	80	182,5	182,5	365	251	190	331	266	14
CVF45-9-2	140	1306	80	182,5	182,5	365	251	190	331	266	14
CVF64-3-1	140	836	100	182,5	182,5	365	251	190	331	266	14
CVF64-4-2	140	919	100	182,5	182,5	365	251	190	331	266	14
CVF64-4	140	919	100	182,5	182,5	365	251	190	331	266	14
CVF64-6-2	140	1084	100	182,5	182,5	365	251	190	331	266	14
CVF90-2	140	773	100	190	190	380	261	199	348	280	14
CVF90-3-2	140	865	100	190	190	380	261	199	348	280	14
CVF90-3	140	865	100	190	190	380	261	199	348	280	14
CVF90-4-2	140	957	100	190	190	380	261	199	348	280	14

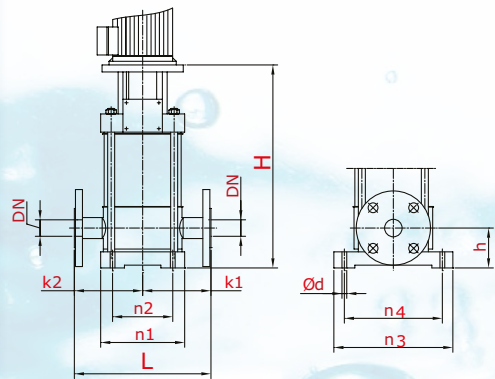

SÜRTME ÇARKLI (PREFERİKAL) POMPALAR

PERIPHERAL PUMPS

TİP TYPE	Bağlantı Giriş x Çıkış Inlet x Outlet	MOTOR						m ³ /h	Debi (Q) - Capacity					FİYAT PRICE (USD)
		HP	kW	V		A			0.6	1	1.5	2	3	
				Mono	Tri	Mono	Tri							
QB60	1"x1"	0,5	0,37	220		2,5		Hm (mSS)	35	29	20	10		\$60
QB60	1"x1"	0,5	0,37		380		1		35	29	20	10		\$65
QB80	1"x1"	1	0,75	220		5,5			60	56	50	40	22	\$100
QB80	1"x1"	1	0,75		380		1,8		60	56	50	40	22	\$110

TEKNİK ÖZELLİKLER

- Çark: Bronz
- Gövde: Pik döküm GG-25 (Gövde iç kısım prinç kaplı)
- Mil: Çelik (C1050 Krom kaplı)
- Sızdırmazlık: Mekanik salmastra (Karbon/Seramik/NBR) Ø12
- Sıvı sıcaklığı: +5°C ~ +60°C
- Devir Hızı: 2900d/dak.
- Koruma sınıfı: IP 44
- İzolasyon sınıfı: F
- Emme derinliği: 6.5mt.

TECHNICAL DATA

- Impeller: Bronze
- Pump Body: GG-25 Cast iron (Brass plated body)
- Shaft: Steel (C1050 Chrome plated)
- Non-Leakage: Mechanical seal (Carbon/Ceramic/NBR) Ø12
- Liquid Temp.: +5°C ~ +60°C
- Speed: 2900 rpm.
- Protection Class: IP44
- Insulation Class: F
- Suction lift: Max 6.5 m.



KULLANIM ALANLARI

- Yüksek basınç
- Hidrofor sistemleri
- Konutlar
- Bahçe sulama
- Endüstri ve inşaatlar
- Besi kazanları

APPLICATIONS

- High pressure
- Booster systems
- Residences
- Irrigation
- Industrial plants, Constructions
- Boilers

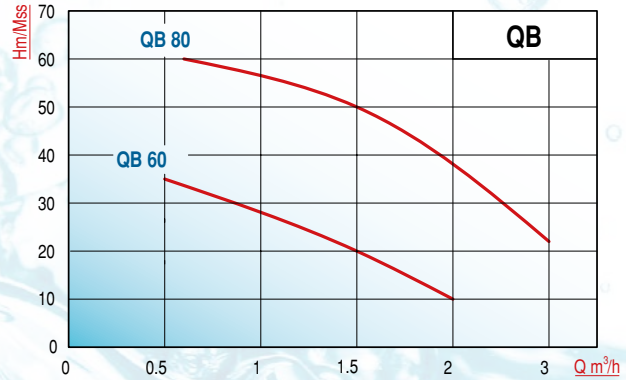
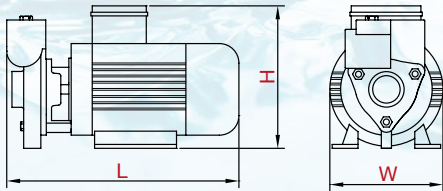

TİP TYPE	Boyutlar - Dimensions (mm)			Ağırlık Weight Kg.
	Boy-L	Yük-H	En-W	
	Length	Height	Width	
QB 60	250	160	125	5.4
QB 80	310	180	130	10

KS

ÇİFT KADEMELİ MONOBLOK POMPALAR

DOUBLE STAGE CLOSE COUPLED PUMPS

TİP TYPE	Bağlantı		MOTOR				m ³ /h	Debi (Q) - Capacity						FİYAT - PRICE (TL)		
	Giriş x Çıkış Inlet x Outlet	HP	kW	V		A		1.5	3	5	7	10	15	MONO	TRİ	
				Mono	Tri	Mono										Tri
KS-115	1"x1"	1.5	1.1	220	380	7.3	2.5	41	38	31	20			Fiyat Sorunuz	19.840 ₺	
KS-12	1"x1"	2	1.5	220	380	11.2	3.18	46	43	37	30			Fiyat Sorunuz	20.855 ₺	
KS-142	1 1/4"x1 1/4"	2	1.5	220	380	11.2	3.18	50	47	43	37	28		Fiyat Sorunuz	21.665 ₺	
KS-143	1 1/4"x1 1/4"	3	2.2	220	380	14.9	4.8	55	53	49	45	38		Fiyat Sorunuz	24.335 ₺	
KS-155	1.5"x1 1/4"	5.5	4.0	-	380	-	8.8	67	64	61	58	52	40	Fiyat Sorunuz	30.550 ₺	
KS-157	1.5"x1.5"	7.5	5.5	-	380/660	-	10.5	70	68	66	62	56	47	Fiyat Sorunuz	32.945 ₺	
KS-255	2"x2"	5.5	4.0	-	380	-	8.8	67	64	61	58	52	40	Fiyat Sorunuz	30.550 ₺	
KS-27	2"x2"	7.5	5.5	-	380/660	-	10.5	70	68	66	62	56	47	Fiyat Sorunuz	32.945 ₺	

TEKNİK ÖZELLİKLER

- MOTOR: Yüksek verimli sınıf
- Çark: Alüminyum/PC
- Gövde: PİK döküm GG-25
- Mil: AISI420 Paslanmaz Çelik
- Sızdırmazlık: Mekanik salmastra (Karbon/Seramik/NBR) (KS-1, KS-14): Ø19, (KS-15, KS-2): Ø25
- Sıvı sıcaklığı: +5°C ~ +60°C
- Devir Hızı: 2900d/dak.
- Koruma sınıfı: IP 54
- İzolasyon sınıfı: F
- Emme derinliği: 6.5mt.

TECHNICAL DATA

- MOTOR: High efficiency class
- Impeller: Aluminium/PC
- Pump Body: GG-25 Cast iron
- Shaft: Stainless Steel (AISI420)
- Non-Leakage: Mechanical seal (Carbon/Ceramic/NBR) (KS-1, KS-14): Ø19, (KS-15, KS-2): Ø25
- Liquid Temp.: +5°C ~ +60°C
- Speed: 2900 rpm.
- Protection Class: IP54
- Insulation Class: F
- Suction lift: Max 6.5 m.

KULLANIM ALANLARI

- Temiz su
- Basıncılı su
- Hidrofor sistemleri
- Konutlar, İş Merkezleri
- Bahçe sulama (Damlama ve Sprink sistemleri)
- Endüstri ve İnşaatlar
- Soğutma sistemleri

APPLICATIONS

- Clean water
- Pressurized water
- Booster systems
- Residences, Business centers
- Irrigation (Drip and Sprinkler systems)
- Industrial plants, Constructions
- Chiller systems



KS-115, KS-12

 KS-155, KS-157
KS-255, KS-27

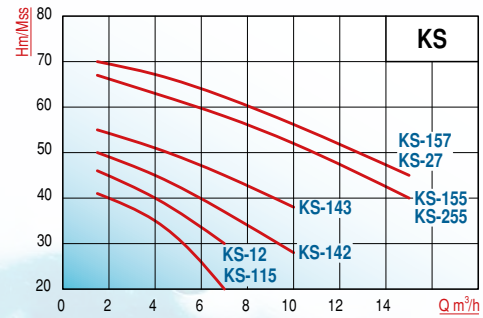
 KS-142, KS-143
KS-255

TİP TYPE	Boyutlar - Dimensions (mm)						Ağırlık - Weight
	A	L	h1	h2	H	E	Kg
KS-115	104	460	96	144	240	195	27
KS-12	104	460	96	144	240	195	29
KS-142	112	470	110	130	240	225	33
KS-143	112	470	110	130	240	225	33
KS-155	90	470	132	168	300	280	40
KS-157	90	515	132	173	305	280	49
KS-255	90	470	132	168	300	280	40
KS-27	90	515	136	169	305	280	49

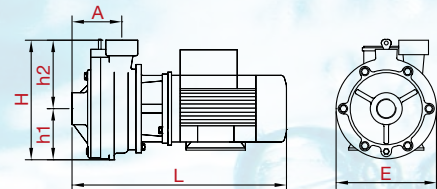

ÇİFT KADEMELİ MONOBLOK POMPALAR

DOUBLE STAGE CLOSE COUPLED PUMPS

TİP TYPE	Bağlantı Giriş x Çıkış Inlet x Outlet	MOTOR						m ³ /h	Debi (Q) - Capacity						FİYAT - PRICE (USD)	
		HP	kW	V		A			1,5	4	6	9	11	15	MONO	TRİ
				Mono	Tri	Mono	Tri									
2HCP25/140H	1¼"x1"	1,5	1,1	220	-	6,8	-	Hm (mSS)	46	40	33				\$260	-
2HCP-160B	1¼"x1"	2	1,5	220	380	10,5	3,8		50	43	34	8			\$305	\$300
2HCP-180	1.5"x1¼"	3	2,2	220	380	11,5	4,5		57	50	41	22	10		\$390	\$375
2HCP-200	1.5"x1¼"	4	3,0	-	380	-	7,5		62	57	52	42	36	10	-	\$420

TEKNİK ÖZELLİKLER

- Çark: Bronz
- Gövde: Pik döküm GG-25
- Mil: Çelik
- Sızdırmazlık: Mekanik salmastra (Karbon/Seramik/NBR) Ø17
- Sıvı sıcaklığı: +5°C ~ +60°C
- Devir Hızı: 2900d/dak.
- Koruma sınıfı: IP 54
- İzolasyon sınıfı: F
- Emme derinliği: 6.5mt.

TECHNICAL DATA

- Impeller: Bronze
- Pump Body: GG-25 Cast iron
- Shaft: Steel
- Non-Leakage: Mechanical seal (Carbon/Ceramic/NBR) Ø17
- Liquid Temp.: +5°C ~ +60°C
- Speed: 2900 rpm.
- Protection Class: IP54
- Insulation Class: F
- Suction lift: Max 6.5 m.

KULLANIM ALANLARI

- Temiz su
- Basıncılı su
- Hidrofor sistemleri
- Konutlar, iş Merkezleri
- Bahçe sulama (Damlama ve Sprink sistemleri)
- Endüstri ve İnşaatlar
- Soğutma sistemleri

APPLICATIONS

- Clean water
- Pressurized water
- Booster systems
- Residences, Business centers
- Irrigation (Drip and Sprinkler systems)
- Industrial plants, Constructions
- Chiller systems

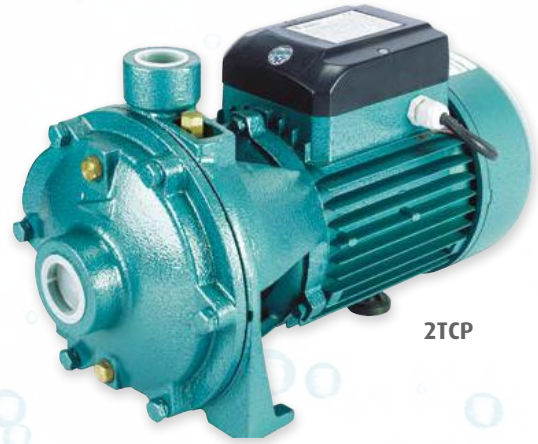

2TCP

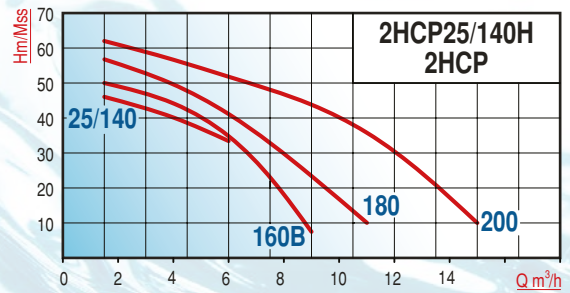
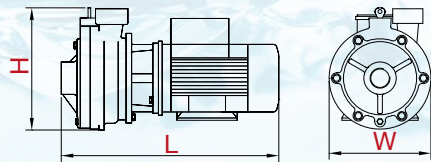

TİP TYPE	Boyutlar - Dimensions (mm)			Ağırlık Weight Kg.
	Boy-L	Yük-H	En-W	
	Length	Height	Width	
2HCP25/140H	445	270	230	22
2HCP-160B	405	270	225	27
2HCP-180	450	290	240	32
2HCP-200	480	320	260	42

CS-1 & CS-15

KOMPAKT MONOBLOK SANTRİFÜJ POMPALAR (KAPALI VE AÇIK ÇARKLI)

COMPACT CLOSE-COUPLED CENTRIFUGAL PUMPS (OPEN AND CLOSED IMPELLER)

TİP TYPE	Bağlantı Giriş x Çıkış Inlet x Outlet	MOTOR						m ³ /h Hm (mSS)	Debi (Q) - Capacity					FİYAT - PRICE (TL)	
		HP	kW	V		A			1.5	3	5	6	8	MONO	TRİ
				Mono	Tri	Mono	Tri								
CS-11	1" x 1"	1	0.75	220	380	4.95	1.8	29	26	21	18	10	Fiyat Sorunuz	15.065 ₺	
CS-115		1.5	1.1	220	380	7.8	2.49	31	29	26	24	20	Fiyat Sorunuz	15.790 ₺	
CS-12		2	1.5	220	380	11.2	3.4	32	31	28	26	23	Fiyat Sorunuz	16.480 ₺	

TİP TYPE	Bağlantı Giriş x Çıkış Inlet x Outlet	MOTOR						m ³ /h Hm (mSS)	Debi (Q) - Capacity					FİYAT - PRICE (TL)	
		HP	kW	V		A			1.5	5	8	12	16	MONO	TRİ
				Mono	Tri	Mono	Tri								
CS-151	1.5" x 1.5"	1	0.75	220	380	4.95	1.8	26	22	17	10	3	Fiyat Sorunuz	15.065 ₺	
CS-155		1.5	1.1	220	380	7.8	2.49	29	25	20	13	6	Fiyat Sorunuz	15.790 ₺	
CS-152		2	1.5	220	380	11.2	3.4	31	28	24	17	9	Fiyat Sorunuz	16.480 ₺	
CS-153		3	2.2	220	380	14.8	4.9	32	30	27	20	12	Fiyat Sorunuz	19.480 ₺	

TEKNİK ÖZELLİKLER

- Çark: PC (CS-1 & CS15) / Alüminyum
- Gövde: Pik döküm GG-25
- Mil: Çelik (AISI 420)
- Sızdırmazlık: Mekanik salmastra (Karbon/Seramik/NBR) Ø19
- Sıvı sıcaklığı: +5°C ~ +60°C
- Devir Hızı: 2900d/dak.
- Frekans: 50Hz
- Koruma sınıfı: IP 54
- İzolasyon sınıfı: F
- Emme derinliği: 6.5mt.

TECHNICAL DATA

- Impeller: PC (CS-1&CS-15) / Aluminium
- Pump Body: GG-25 Cast iron
- Shaft: Steel (AISI 420)
- Non-Leakage: Mechanical seal (Carbon/Ceramic/NBR) Ø19
- Liquid Temp.: +5°C ~ +60°C
- Speed: 2900 rpm.
- Frequency: 50Hz
- Protection Class: IP54
- Insulation Class: F
- Suction lift: Max 6.5 m.

KULLANIM ALANLARI

- Temiz su temini
- Bahçe sulama (Damla ve Sprink sistemleri)
- Endüstri ve İnşaatlar
- Soğutma sistemleri

APPLICATIONS

- Clean water supply
- Irrigation (Drip and Sprinkler systems)
- Industrial plants, Constructions
- Chiller systems

OPSİYONEL

- Açık Çark
- Bronz Çark
- AISI 316 / AISI 304 Çelik Mil

OPTIONAL

- Open Impeller
- Bronze Impeller
- AISI 316 / AISI 304 S/S Shaft



CS-1
CS-15

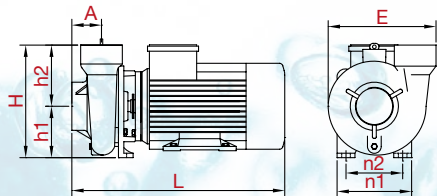

TİP TYPE	Boyutlar - Dimensions (mm)								Ağırlık - Weight Kg
	A	L	h1	h2	H	E	n1	n2	
CS-11	40	355	96	144	240	190	185	142	18
CS-115	40	355	96	144	240	190	185	142	19
CS-12	40	390	96	159	255	200	185	142	24
CS-151	60	365	95	140	235	190	185	142	19
CS-155	60	365	95	140	235	190	185	142	20
CS-152	60	390	95	160	255	200	185	142	24
CS-153	60	380	95	165	260	190	185	142	25

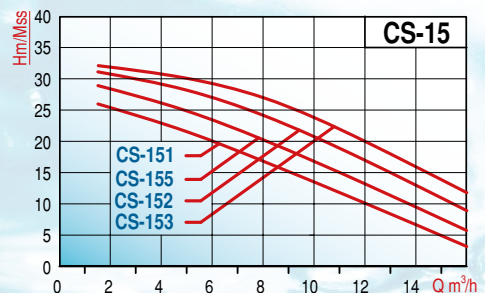
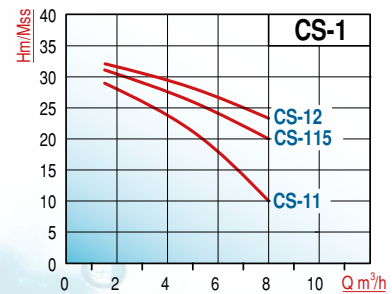

CS-2 & CS-3

KOMPAKT MONOBLOK SANTRİFÜJ POMPALAR (KAPALI VE AÇIK ÇARKLI)

COMPACT CLOSE-COUPLED CENTRIFUGAL PUMPS (OPEN AND CLOSED IMPELLER)

TİP TYPE	Bağlantı Giriş x Çıkış Inlet x Outlet	MOTOR						m ³ /h	Debi (Q) - Capacity					FİYAT - PRICE (TL)	
		HP	kW	V		A			7	14	21	27	30	MONO	TRİ
				Mono	Tri	Mono	Tri								
CS-21	2" x 2"	1	0.75	220	380	4.95	1.8	Hm (mSS)	15	11	5			Fiyat Sorunuz	15.310 ₺
CS-215		1.5	1.1	220	380	7.8	2.5		20	16	10	3		Fiyat Sorunuz	15.925 ₺
CS-22		2	1.5	220	380	11.2	3.4		24	20	14	8	4	Fiyat Sorunuz	16.840 ₺
CS-23		3	2.2	220	380	14.8	4.9		28	25	19	13	9	Fiyat Sorunuz	19.355 ₺

TİP TYPE	Bağlantı Giriş x Çıkış Inlet x Outlet	MOTOR						m ³ /h	Debi (Q) - Capacity					FİYAT - PRICE (TL)	
		HP	kW	V		A			20	30	40	50	60	MONO	TRİ
				Mono	Tri	Mono	Tri								
CS-315	3" x 3"	1.5	1.1	220	380	7.8	2.5	Hm (mSS)	11	9	6	2		Fiyat Sorunuz	16.595 ₺
CS-32		2	1.5	220	380	11.2	3.4		14	12	9	5	1	Fiyat Sorunuz	17.685 ₺
CS-33		3	2.2	220	380	14.8	4.9		17	15	12	9	5	Fiyat Sorunuz	20.100 ₺

TEKNİK ÖZELLİKLER

- Çark: GG-25 PİK (CS-2 & CS-3)
- Gövde: PİK döküm GG-25
- Mil: Çelik (AISI 420)
- Sızdırmazlık: Mekanik salmastra (Karbon/Seramik/NBR) Ø19
- Sıvı sıcaklığı: +5°C ~ +60°C
- Devir Hızı: 2900d/dak.
- Frekans: 50Hz
- Koruma sınıfı: IP 54
- İzolasyon sınıfı: F
- Emme derinliği: 6.5mt.

TECHNICAL DATA

- Impeller: Cast iron GG-25 (CS-2 & CS-3)
- Pump Body: GG-25 Cast iron
- Shaft: Steel (AISI 420)
- Non-Leakage: Mechanical seal (Carbon/Ceramic/NBR) Ø19
- Liquid Temp.: +5°C ~ +60°C
- Speed: 2900 rpm.
- Frequency: 50Hz
- Protection Class: IP54
- Insulation Class: F
- Suction lift: Max 6.5 m.



CS-2



CS-3

KULLANIM ALANLARI

- Temiz su temini
- Bahçe sulama (Damlatma ve Sprink sistemleri)
- Endüstri ve inşaatlar
- Soğutma sistemleri

APPLICATIONS

- Clean water supply
- Irrigation (Drip and Sprinkler systems)
- Industrial plants, Constructions
- Chiller systems

OPSİYONEL

- Açık Çark
- Bronz Çark
- AISI 316 / AISI 304 Çelik Mil

OPTIONAL

- Open Impeller
- Bronze Impeller
- AISI 316 / AISI 304 S/S Shaft

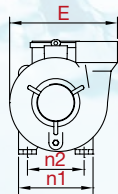
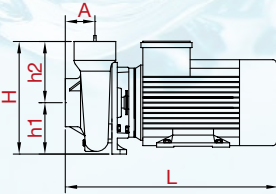

TİP TYPE	Boyutlar - Dimensions (mm)								Ağırlık - Weight
	A	L	h1	h2	H	E	n1	n2	Kg
CS-21	52	370	95	175	270	200	185	142	20
CS-215	52	370	95	175	270	200	185	142	22
CS-22	52	390	95	165	260	210	185	142	26
CS-23	52	395	95	170	265	200	185	142	27
CS-315	64	390	106	164	270	240	185	142	23
CS-32	64	430	106	164	270	240	185	142	28
CS-33	64	430	106	164	270	240	185	142	30

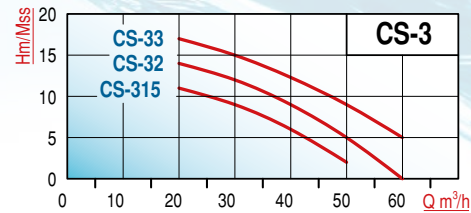
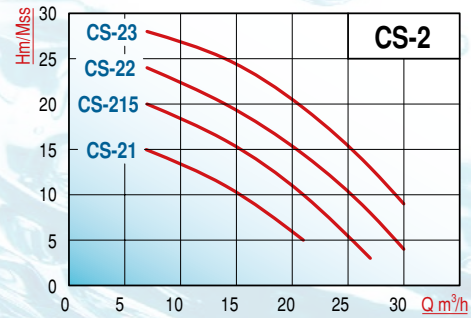

VS (3000 d/d) MONOBLOK SALYANGOZ POMPALAR

VOLUTE CASING CLOSE-COUPLED PUMPS

TİP TYPE	Bağlantı Giriş x Çıkış Inlet x Outlet	MOTOR					m ³ /h Hm (mSS)	Debi (Q) - Capacity						FİYAT - PRICE (TL)						
		HP	kW	V	A			15	25	35	45	55	65	Şasesiz	Şaseli					
	Mono				Tri	Excl. Base								Incl. Base						
VS-253	2.5" x 2.5"	3	2,2	220	380	14,9	-	23	22	15	5	23	22	15	5	Fiyat Sorunuz	Fiyat Sorunuz			
VS-253		3	2,2															-	4,8	
VS-254		4	3															-	6,3	
VS-324	3" x 2.5"	4	3	380	-	6,3	27	26	23	18	10	27	26	23	18	10	23.420 ₺	23.600 ₺		
VS-325		5,5	4																-	8,6

TEKNİK ÖZELLİKLER

- Çark: GG-25 Pik döküm
- Gövde: Pik döküm GG-25
- Mil: AISI420 Paslanmaz Çelik
- Eksenel yük dengeleme delikleri ile dengelenir.
- Sızdırmazlık: Mekanik salmastra (Karbon/Seramik/NBR) Ø25
- Sıvı sıcaklığı: +5°C ~ +60°C
- Devir Hızı: 2900d/dak.
- Koruma sınıfı: IP 54
- İzolasyon sınıfı: F
- Emme derinliği: 6.5mt.

TECHNICAL DATA

- Impeller: GG-25 Cast iron
- Pump Body: GG-25 Cast iron
- Shaft: Stainless Steel (AISI420)
- Axial load is reduced by balance holes
- Non-Leakage: Mechanical seal (Carbon/Ceramic/NBR) Ø25
- Liquid Temp.: +5°C ~ +60°C
- Speed: 2900 rpm.
- Protection Class: IP54
- Insulation Class: F
- Suction lift: Max 6.5 m.



KULLANIM ALANLARI

- Temiz su temini
- Tarımsal sulama (Damlatma ve Sprink sistemleri)
- Endüstri ve inşaatlar
- Soğutma sistemleri
- Sirkülasyon

APPLICATIONS

- Clean water supply
- Irrigation (Drip and Sprinkler systems)
- Industrial plants, Constructions
- Chiller systems
- Circulation

OPSİYONEL

- Açık Çark
- Bronz Çark
- AISI 316 / AISI 304 Çelik Mil

OPTIONAL

- Open Impeller
- Bronze Impeller
- AISI 316 / AISI 304 S/S Shaft

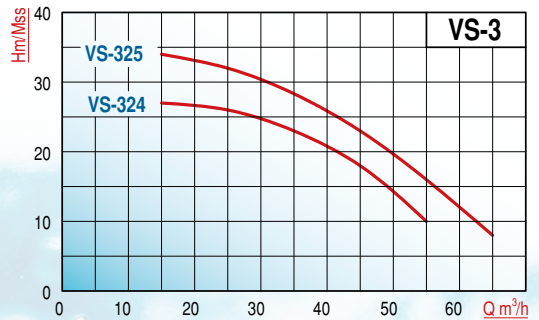
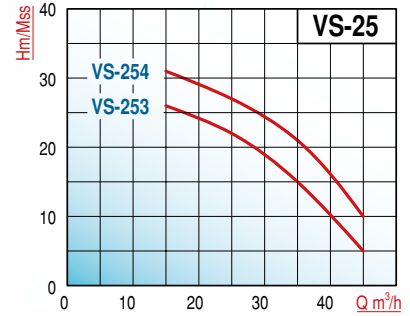
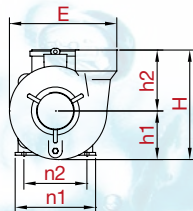
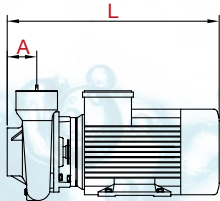

TİP TYPE	Boyutlar - Dimensions (mm)								Ağırlık - Weight
	A	L	h1	h2	H	E	n1	n2	Kg
VS-253	65	440	110	145	255	285	165	140	35
VS-254	65	440	110	145	255	285	165	140	36,5
VS-324	65	500	114	143	257	285	165	140	44,5
VS-325	65	500	114	143	257	285	191	158	46

MONOBLOK SANTRİFÜJ POMPALAR

CENTRIFUGAL PUMPS

TİP TYPE	Bağlantı Giriş x Çıkış Inlet x Outlet	MOTOR						m ³ /h Hm (mSS)	Debi (Q) - Capacity						FİYAT PRICE (USD)
		HP	kW	V		A			2	4	6	15	25	30	
				Mono	Tri	Mono	Tri								
CPM-158	1"x1"	1	0.75	220	-	4.8	-	Hm (mSS)	30	25	18				\$140
THF6C-1	2"x2"	1.5	1.1	220	-	6.8	-				20	19	15	10	\$225

TİP TYPE	Bağlantı Giriş x Çıkış Inlet x Outlet	MOTOR						m ³ /h Hm (mSS)	Debi (Q) - Capacity					FİYAT PRICE (USD)
		HP	kW	V		A			20	35	50	70	80	
				Mono	Tri	Mono	Tri							
HFM-80	3"x3"	2	1,5	220	-	8,6	-	Hm (mSS)	11	8	3			\$270

TEKNİK ÖZELLİKLER

- Çark: Bronz
- Gövde: Pik döküm GG-25
- Mil: Çelik (C1050 Krom kaplı)
- Sızdırmazlık: Mekanik salmastra (Karbon/Seramik/NBR)
CPM: Ø14, THF: Ø17
HFM-80: Ø18, HFM-95: Ø19, HFM-105: Ø22
- Sıvı sıcaklığı: +5°C ~ +60°C
- Devir Hızı: 2900d/dak.
- Frekans: 50Hz
- Koruma sınıfı: IP 54
- İzolasyon sınıfı: F
- Emme derinliği: 6.5mt.

TECHNICAL DATA

- Impeller: Bronze
- Pump Body: GG-25 Cast iron
- Shaft: Steel (C1050 Chrome plated)
- Non-Leakage: Mechanical seal (Carbon/Ceramic/NBR)
CPM: Ø14, THF: Ø17
HFM-80: Ø18, HFM-95: Ø19, HFM-105: Ø22
- Liquid Temp.: +5°C ~ +60°C
- Speed: 2900 rpm.
- Frequency: 50Hz
- Protection Class: IP54
- Insulation Class: F
- Suction lift: Max 6.5 m.

KULLANIM ALANLARI

- Temiz su temini
- Bahçe sulama (Damlama ve Sprink sistemleri)
- Endüstri ve İnşaatlar
- Soğutma sistemleri

APPLICATION AREAS

- Clean water supply
- Irrigation (Drip and Sprinkler systems)
- Industrial plants, Constructions
- Chiller systems

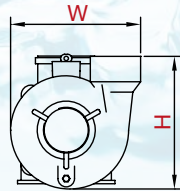
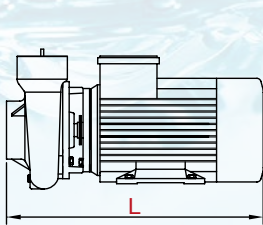

TİP TYPE	Boyutlar - Dimensions (mm)			Ağırlık Weight Kg.
	Boy-L	Yük-H	En-W	
	Length	Height	Width	
CPM-158	320	240	195	13.5
THF 6C-1	385	260	210	18
HFM-80	405	310	245	30.5
HFM-105	485	340	275	39

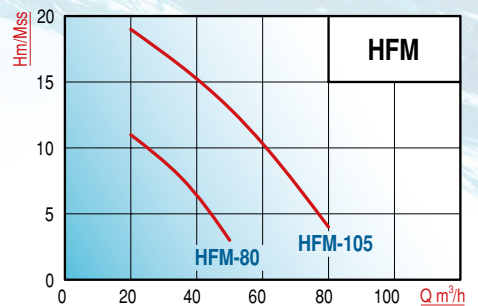
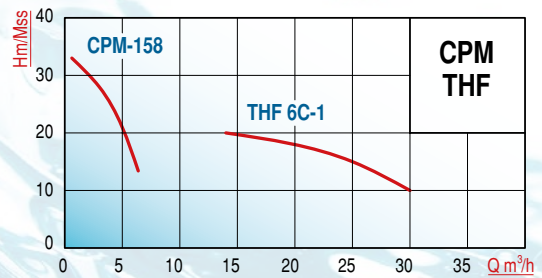

JET POMPALAR (Kendinden Emişli)

JET PUMPS (Self-priming)

TİP TYPE	Bağlantı		MOTOR				m ³ /h	Debi (Q) - Capacity					FİYAT PRICE (USD)	
	Giriş x Çıkış Inlet x Outlet	HP	kW	V		A		0.5	1	2	3	5		
				Mono	Tri	Mono								Tri
JET100B	1"x1"	1	0.80	220	-	4.8	-	42	39	30	20		\$135	
JET180A	1¼"x1"	1.5	1.1	220	-	9	-	60	57	52	45	20	\$225	
SJET-100C PASLANMAZ JET	1"x1"	1	0.80	220	-	3.8	-	42	38	24			\$145	

TEKNİK ÖZELLİKLER

- Çark: Bronz
- Difüzör: PC
- Gövde: Pik döküm GG-25
- Ejektörlü
- Emme derinliği: 8 mt.
- Kendinden emişli (İlk çalıştırmada gövde tamamen su dolu olmalıdır. 2-3dk içerisinde su emilecektir.)
- Mil: Çelik (C1050 Krom kaplı)
- Sızdırmazlık: Mekanik salmastra (Karbon/Seramik/NBR) (JET100, SG): Ø14, JET180: Ø16
- Sıvı sıcaklığı: +5°C ~ +60°C
- Devir Hızı: 2900d/dak.
- Koruma sınıfı: IP 54
- İzolasyon sınıfı: F

KULLANIM ALANLARI

- Temiz su temini
- Hidrofor sistemleri
- Bahçe sulama (Damlama ve Sprink sistemleri)
- Endüstri ve İnşaatlar
- Evler

TECHNICAL DATA

- Impeller: Bronz
- Diffuser: PC
- Pump Body: GG-25 Cast iron
- Built-in ejector
- Suction lift: Max 8 m.
- Self-priming (Pump Body should be completely filled with water before first run of the pump, pump will suct within 2-3 min. from. max 8 meters depth)
- Shaft: Steel (C1050 Chrome plated)
- Non-Leakage: Mechanical seal (Carbon/Ceramic/NBR) (JET100, SG): Ø14, JET180: Ø16
- Liquid Temp.: +5°C ~ +60°C
- Speed: 2900 rpm.
- Protection Class: IP54
- Insulation Class: F

APPLICATIONS

- Clean water supply
- Booster systems
- Irrigation (Drip and Sprinkler systems)
- Industry, Constructions
- Residences

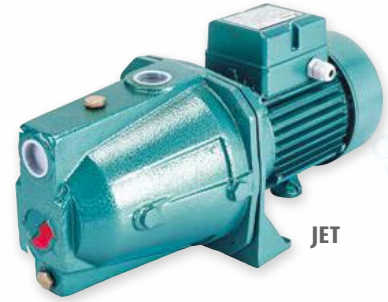

JET



SJET

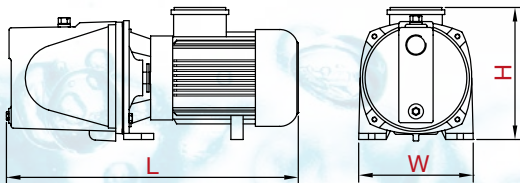

TİP TYPE	Boyutlar - Dimensions (mm)			Ağırlık Weight Kg.
	Boy-L	Yük-H	En-W	
	Length	Height	Width	
JET 100B	445	220	175	15
JET 180A	510	245	210	23
SJET-100A	375	220	195	8

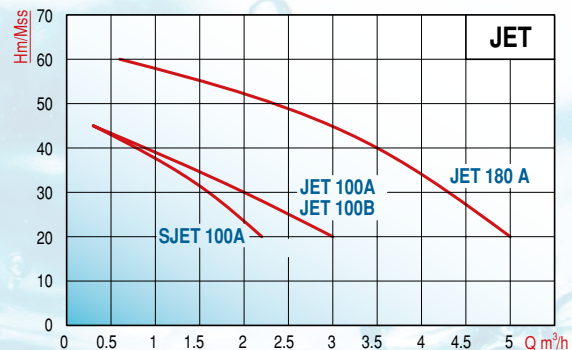

CAS (3000 d/d) MONOBLOK SALYANGOZ POMPALAR

VOLUTE CASING CLOSE-COUPLED PUMPS

TİP TYPE	Bağlantı		MOTOR				m ³ /h	Debi (Q) - Capacity							FİYAT - PRICE (TL)	
	Giriş x Çıkış Inlet x Outlet	HP	kW	V	A	20		30	40	50	60	70	Şasesiz			
													Excl. Base	Şaseli		
CAS-4	3" x 2.5"	4	3	380	6.3	Hm (mSS)	27	25	20	13	5		30.340 ₺	30.585 ₺		
CAS-5.5		5.5	4	380	8.6		31	29	25	19	11		33.155 ₺	33.395 ₺		
CAS-7.5		7.5	5.5	380/660	10.3		36	34	31	26	20		34.410 ₺	34.650 ₺		
CAS-10		10	7.5	380/660	14.2		46	44	41	35	26	10	36.925 ₺	37.170 ₺		
CAS-15		15	11	380/660	21		57	55	52	48	40	19	48.745 ₺	48.990 ₺		
CAS-20		20	15	380/660	28		67	66	63	58	50	28	58.820 ₺	59.065 ₺		

Flanşlar hariçtir. Takım fiyatı (Flange Set): 2.060 TL

TEKNİK ÖZELLİKLER

- MOTOR: Yüksek verimli sınıf
- Çark: GG-25 Pik döküm/Bronz (Opsiyonel)
- Gövde: Pik döküm GG-25
- Mil: X20Cr13 (AISI420), Opsiyonel: AISI316 çelik
- Eksenel yük dengeleme delikleri ile dengelenir.
- Flanşlar: Giriş DN80 (PN 16) - Çıkış DN65 (PN 40) (Flanşlar opsiyoneldir.)
- Sızdırmazlık: Mekanik salmastra (Karbon/Seramik/NBR) Ø25
- Sıvı sıcaklığı: +5°C ~ +60°C
- Devir Hızı: 2900d/dak.
- Koruma sınıfı: IP 54
- İzolasyon sınıfı: F
- Emme derinliği: 6.5mt.

TECHNICAL DATA

- MOTOR: High efficiency class
- Impeller: GG-25 Cast iron /Bronze (Optional)
- Pump Body: GG-25 Cast iron
- Pump Shaft: X20Cr13 (AISI420) steel, Optional: AISI316 stainless steel.
- Axial load is reduced by balance holes
- Flanges: Inlet DN80 (PN 16) Outlet DN65 (PN 40) (Flanges are optional)
- Non-Leakage: Mechanical seal (Carbon/Ceramic/NBR) Ø25
- Liquid Temp.: +5°C ~ +60°C
- Speed: 2900 rpm.
- Protection Class: IP54
- Insulation Class: F
- Suction lift: Max 6.5 m.



KULLANIM ALANLARI

- Temiz su temini
- Tarımsal sulama (Damla ve Sprink sistemleri)
- Buhar kazanları besli,
- Kondens sistemleri
- Endüstri ve İnşaatlar
- Soğutma sistemleri
- Sirkülasyon
- Yangın söndürme

APPLICATIONS

- Clean water supply
- Irrigation (Drip and Sprinkler systems)
- Boiler feeding
- Condens systems
- Industrial plants, Constructions
- Chiller systems
- Circulation
- Fire fighting

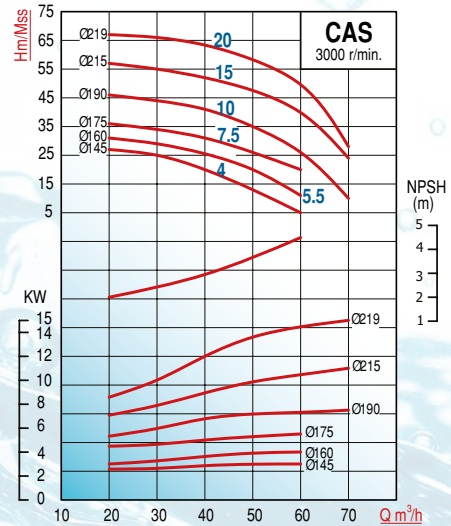
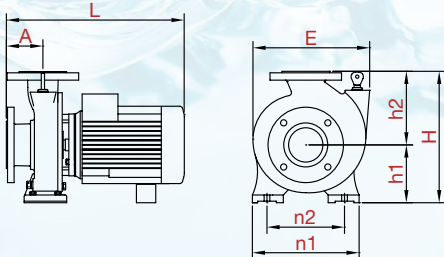

TİP TYPE	Boyutlar - Dimensions (mm)								Ağırlık - Weight
	A	L	h1	h2	H max	E	n1	n2	Kg
CAS-4	92	470	165	191	356	280	278	207	61
CAS-5.5	92	470	165	191	356	280	278	207	63
CAS-7.5	92	515	165	191	356	280	278	207	71
CAS-10	92	515	165	191	356	280	278	207	83
CAS-15	92	570	165	191	356	280	278	207	97
CAS-20	92	630	165	191	356	280	278	207	100

CES SERİSİ (3000 d/d & 1500 d/d) (TS EN 733) MONOBLOK SALLYANGOZ POMPALAR

VOLUTE CASING CLOSE-COUPLED PUMPS



TEKNİK ÖZELLİKLER

- Motor: IE3 Sınıfı (Yüksek Verimli, Enerji Tasarruflu)
- Kapasite: 15 - 320 m³/h
- Basma Yüksekliği: 15 - 130 m
- Devir Hızı: 3000 d/d, 1500 d/d
- Sıvı Sıcaklığı: -10 °C ~ +105 °C
- Flanşlar TS EN 1092 - 2 / PN 16' ya uygundur.
- Giriş Flanşları: DN65 - DN125
- Çıkış Flanşları: DN 40 - DN100
- İzolasyon sınıfı: F
- Koruma sınıfı: IP55
- Emme derinliği: 6.5m't.
- Pompa Mili IEC ölçülerine uygun Genel maksat tip motorlara geçme şekilde akuplaj yapılmıştır. Bu şekil akuplaj Pompa ve Motor milinin aynı hızada olmasını sağlar. Böylece çarkın dinamik ve statik olarak dengede çalışması sağlanır.
- Yataklama: Pompa Mili, Arapça denge rulmanı ve motor rulmanları tarafından yataklanır.
- Eksenal yük dengeleme delikleri ile dengelenir.

MALZEME ÖZELLİKLERİ

- Çark: PİK GG-25 PİK Döküm
- Gövde: GG-25 PİK Döküm
- Mil: X20Cr13 (AISI420), Opsiyonel: AISI316 çelik
- Sızdırmazlık: Mekanik salmastra (Karbon-Silisyum/Viton)
- Aşınma Halkası: GG-25 PİK Döküm

KULLANIM ALANLARI

- Temiz su temini
- Endüstriyel tesisler
- Hidrofor sistemleri
- Yangın söndürme sistemleri
- Buhar kazanları besli, kondens sistemleri
- Soğutma sistemleri
- Yağmurlama ve sprinkler sulama
- Sirkülasyon

OPSİYONEL

- Açık Çark
- Bronz Çark
- AISI 316 / AISI 304 Çelik Mil

TECHNICAL DATA

- Motor: IE3 Class (High Efficiency, Energy Saving)
- Capacity: 15 - 320 m³/h
- Total Head: 15 - 130
- Rotation Speed: 3000 rpm, 1500 rpm
- Liquid Temp.: -10°C ~ +105°C
- Suction and discharge flanges conform to EN 1092-2 / PN 16
- Inlet Flanges: DN65 - DN125
- Outlet Flanges: DN40 - DN100
- Insulation Class: F
- Protection Class: IP55
- Suction lift: Max 6.5 m.
- CES series are designed to be driven by IEC standard motor. Pump shaft and motor shaft are close-coupled design. This way of coupling ensures the alignment of pump and motor. Therefore impeller runs in good balance both dynamically and statically.
- Bearing: Pump Shaft is supported by the ball bearing on pump support also by the ball bearings on electric motor.
- Axial load is reduced by balance holes

MATERIAL SPECIFICATIONS

- Impellers: Cast iron GG-25
- Body: Cast iron GG-25
- Pump Shaft: X20Cr13 (AISI420) steel, Optional: AISI316 stainless steel.
- Non-Leakage: Mechanical seal (Carbon -Sic/Viton)
- Wear Ring: Cast iron GG-25

APPLICATIONS

- Clean water supply
- Industry
- Booster systems
- Fire fighting systems
- Boiler feeding, condens systems
- Chiller systems
- Irrigation, sprinkler systems
- Circulation

OPTIONAL

- Open Impeller
- Bronze Impeller
- AISI 316 / AISI 304 S/S Shaft

CES40 (3000 d/d)

MONOBLOK SALLYANGOZ POMPALAR

VOLUTE CASING CLOSE-COUPLED PUMPS

TİP TYPE	Bağlantı Giriş x Çıkış Inlet x Outlet	MOTOR						m ³ /h	Debi (Q) - Capacity						FİYAT - PRICE (TL)			
		HP	kW	IEC	V	A	d/d		m ³ /h						Tek Pompa Bare Pump	Şasesiz Excl. Base	Şaseli Incl. Base	
									10	15	20	30	40	50				
CES40-16 04002	2.5"x1.5"	5,5	4	100L	380	8	3000	Hm(mSS)	32	31	29	24			24.260 ₺	37.560 ₺	38.235 ₺	
CES40-16 05502		7,5	5,5	112M	380/660	10,9			40	39	38	34	23			24.260 ₺	38.900 ₺	39.575 ₺
CES40-16 07502		10	7,5	112M		14,1			48	47	46	44	37	22			24.260 ₺	42.570 ₺
CES40-16 11002		15	11	132M	21	53			52	51	49	44	34			25.620 ₺	53.035 ₺	53.710 ₺

Flanşlar hariçtir. Takım fiyatı: 1.515 TL

TİP TYPE	Bağlantı Giriş x Çıkış Inlet x Outlet	MOTOR						m ³ /h	Debi (Q) - Capacity						FİYAT - PRICE (TL)				
		HP	kW	IEC	V	A	d/d		m ³ /h						Tek Pompa Bare Pump	Şasesiz Excl. Base	Şaseli Incl. Base		
									15	25	35	40	45	50					
CES40-20 04002	2.5"x1.5"	5,5	4	100L	380	8	3000	Hm (mSS)	37	20	5				28.880 ₺	39.405 ₺	40.080 ₺		
CES40-20 05502		7,5	5,5	112M	380/660	10,9			44	35	20	15				28.880 ₺	40.745 ₺	41.420 ₺	
CES40-20 07502		10	7,5	112M		14,1			49	46	40	34	24				28.880 ₺	44.410 ₺	45.085 ₺
CES40-20 11002		15	11	132M	21	58			57	53	50	45	38				30.030 ₺	54.560 ₺	55.235 ₺
CES40-20 15002		20	15	160L	28	69			68	66	64	60	54				30.030 ₺	62.585 ₺	63.450 ₺

Flanşlar hariçtir. Takım fiyatı: 1.515 TL

TİP TYPE	Bağlantı Giriş x Çıkış Inlet x Outlet	MOTOR						m ³ /h	Debi (Q) - Capacity						FİYAT - PRICE (TL)					
		HP	kW	IEC	V	A	d/d		m ³ /h						Tek Pompa Bare Pump	Şasesiz Excl. Base	Şaseli Incl. Base			
									10	20	30	40	50	60						
CES40-26 15002	2.5"x1.5"	20	15	160L	380/660	28	3000	Hm (mSS)	70	68	63	57	49		34.010 ₺	70.345 ₺	71.210 ₺			
CES40-26 18502		25	18,5	160L		34			78	76	71	65	59	51			34.010 ₺	74.600 ₺	75.465 ₺	
CES40-26 22002		30	22	160L		40,5			90	88	83	76	69	60				34.010 ₺	84.665 ₺	85.530 ₺
CES40-26 30002		40	30	200L		54.6			98	97	93	87	80	71				35.310 ₺	116.015 ₺	117.150 ₺

Flanşlar hariçtir. Takım fiyatı: 1.515 TL

TİP TYPE	Bağlantı Giriş x Çıkış Inlet x Outlet	MOTOR						m ³ /h	Debi (Q) - Capacity						FİYAT - PRICE (TL)				
		HP	kW	IEC	V	A	d/d		m ³ /h						Tek Pompa Bare Pump	Şasesiz Excl. Base	Şaseli Incl. Base		
									10	20	30	35	40	50					
CES40-32 30002	2.5"x1.5"	40	30	200L	380/660	54.6	3000	Hm (mSS)	105	103	99	97	94		41.005 ₺	121.165 ₺	122.300 ₺		
CES40-32 37002		50	37	200L		68			130	129	124	121	118	110			41.005 ₺	130.650 ₺	131.785 ₺
CES40-32 45002		60	45	200L		83,8			143	142	137	134	131	123				41.005 ₺	138.540 ₺

Flanşlar hariçtir. Takım fiyatı: 1.515 TL



CES40 (3000 d/d) MONOBLOK SALYANGOZ POMPALAR

VOLUTE CASING CLOSE-COUPLED PUMPS

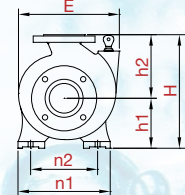
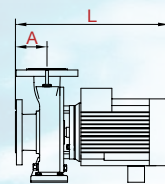
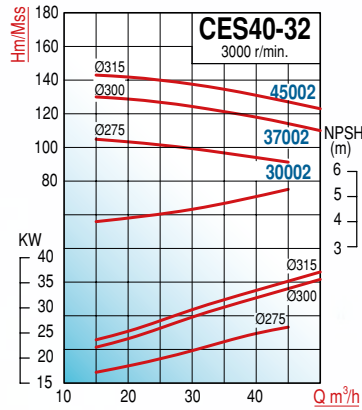
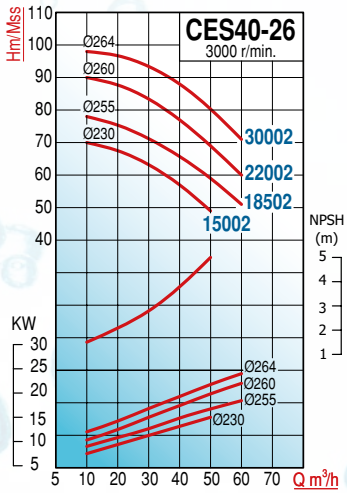
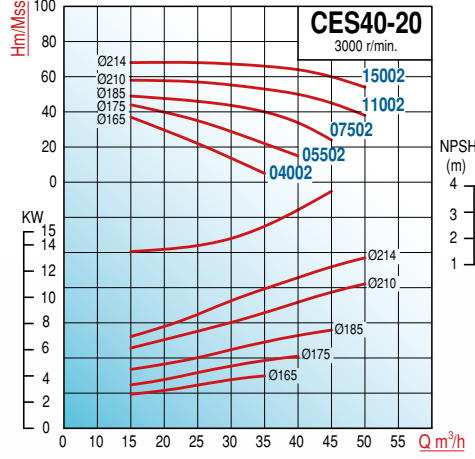
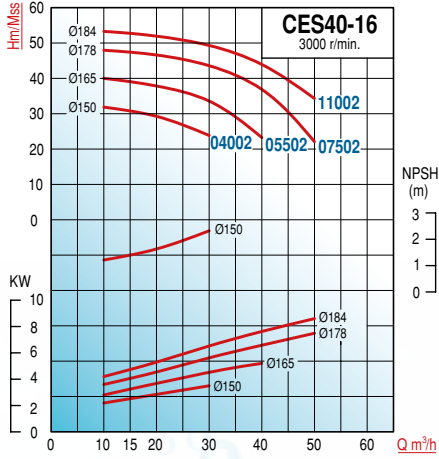

TİP TYPE	Boyutlar - Dimensions (mm)								Ağırlık - Weight
	A	L	h1	h2	H	E	n1	n2	Kg
CES40-16 04002	80	549	132	160	292	246	240	190	50
CES40-16 05502	80	568	132	160	292	246	240	190	56
CES40-16 07502	80	568	132	160	292	246	240	190	56
CES40-16 11002	80	721	132	160	292	246	240	190	81
CES40-20 04002	100	608	160	180	340	276	265	212	61
CES40-20 05502	100	651	160	180	340	276	265	212	65
CES40-20 07502	100	651	160	180	340	276	265	212	71
CES40-20 11002	100	713	160	180	340	276	265	212	92
CES40-20 15002	100	779	160	180	380	350	265	212	132
CES40-26 15002	100	794	180	225	405	350	320	250	144
CES40-26 18502	100	794	180	225	405	350	320	250	159
CES40-26 22002	100	794	180	225	405	350	320	250	158
CES40-26 30002	100	885	180	225	461	400	320	250	208
CES40-32 30002	125	908	200	250	461	400	345	280	231
CES40-32 37002	125	908	200	250	461	400	345	280	250
CES40-32 45002	125	908	200	250	461	400	345	280	287

CESS50 (3000 d/d) MONOBLOK SALYANGOZ POMPALAR

VOLUTE CASING CLOSE-COUPLED PUMPS

TİP TYPE	Bağlantı Giriş x Çıkış Inlet x Outlet	MOTOR						m ³ /h Hm (mSS)	Debi (Q) - Capacity						FİYAT - PRICE (TL)			
		HP	kW	IEC	V	A	d/d		Debi (Q) - Capacity						Tek Pompa Bare Pump	Şasesiz Excl. Base	Şaseli Incl. Base	
									20	30	40	50	60	70				
CESS50-16 05502	2.5" x 2"	7,5	5,5	112M	380/660	10,9	3000	Hm (mSS)	29	28	26	22			24.795 ₺	39.435 ₺	40.110 ₺	
CESS50-16 07502		10	7,5	112M		14,1			37	36	34	31	26			24.795 ₺	43.100 ₺	43.775 ₺
CESS50-16 11002		15	11	132M		21			47	47	45	42	39	35			26.150 ₺	53.570 ₺

Flanşlar hariçtir. Takım fiyatı: 1.620 TL

TİP TYPE	Bağlantı Giriş x Çıkış Inlet x Outlet	MOTOR						m ³ /h Hm (mSS)	Debi (Q) - Capacity						FİYAT - PRICE (TL)			
		HP	kW	IEC	V	A	d/d		Debi (Q) - Capacity						Tek Pompa Bare Pump	Şasesiz Excl. Base	Şaseli Incl. Base	
									30	40	50	60	75	90				
CESS50-20 11002	2.5" x 2"	15	11	132M	380/660	21	3000	Hm (mSS)	46	45	43	40	34		30.710 ₺	55.170 ₺	55.845 ₺	
CESS50-20 15002		20	15	160L		28			54	53	51	48	42	34		30.710 ₺	63.195 ₺	64.060 ₺
CESS50-20 18502		25	18,5	160L		34			61	60	59	56	51	43		32.020 ₺	72.805 ₺	73.670 ₺
CESS50-20 22002		30	22	160L		40,5			66	65	64	62	57	50		32.020 ₺	82.865 ₺	83.730 ₺

Flanşlar hariçtir. Takım fiyatı: 1.620 TL

TİP TYPE	Bağlantı Giriş x Çıkış Inlet x Outlet	MOTOR						m ³ /h Hm (mSS)	Debi (Q) - Capacity						FİYAT - PRICE (TL)			
		HP	kW	IEC	V	A	d/d		Debi (Q) - Capacity						Tek Pompa Bare Pump	Şasesiz Excl. Base	Şaseli Incl. Base	
									30	40	55	70	85	105				
CESS50-26 18502	2.5" x 2"	25	18,5	160L	380/660	34	3000	Hm (mSS)	67	65	60	54	45		34.425 ₺	74.980 ₺	75.845 ₺	
CESS50-26 22002		30	22	160L		40,5			75	73	68	62	53		34.425 ₺	85.040 ₺	85.905 ₺	
CESS50-26 30002		40	30	200L		54,6			93	91	86	79	70	55		35.725 ₺	116.395 ₺	117.530 ₺
CESS50-26 37002		50	37	200L		68			101	99	94	87	79	64		35.725 ₺	125.880 ₺	127.015 ₺

Flanşlar hariçtir. Takım fiyatı: 1.620 TL

TİP TYPE	Bağlantı Giriş x Çıkış Inlet x Outlet	MOTOR						m ³ /h Hm (mSS)	Debi (Q) - Capacity						FİYAT - PRICE (TL)		
		HP	kW	IEC	V	A	d/d		Debi (Q) - Capacity						Tek Pompa Bare Pump	Şasesiz Excl. Base	Şaseli Incl. Base
									30	45	60	75	90	105			
CESS50-32 30002	2.5"x2"	40	30	200L	380/660	54,6	3000	Hm (mSS)	88	87	83	72	52		41.615 ₺	121.720 ₺	122.855 ₺
CESS50-32 37002		50	37	200L		68			99	98	95	87	68		41.615 ₺	131.205 ₺	132.340 ₺
CESS50-32 45002		60	45	200L		83,8			112	111	107	99	84	52		41.615 ₺	139.095 ₺

Flanşlar hariçtir. Takım fiyatı: 1.620 TL



CES50 (3000 d/d) MONOBLOK SALYANGOZ POMPALAR

VOLUTE CASING CLOSE-COUPLED PUMPS

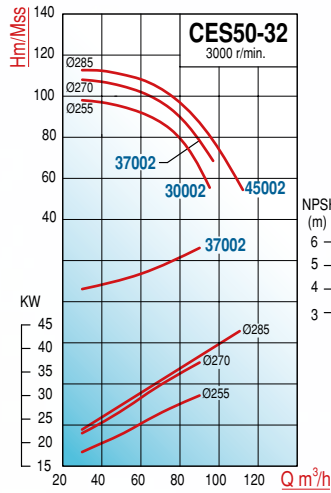
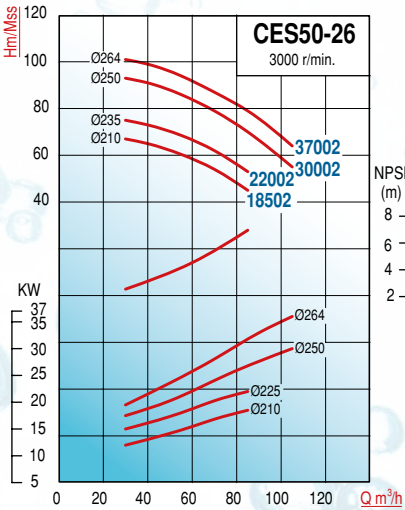
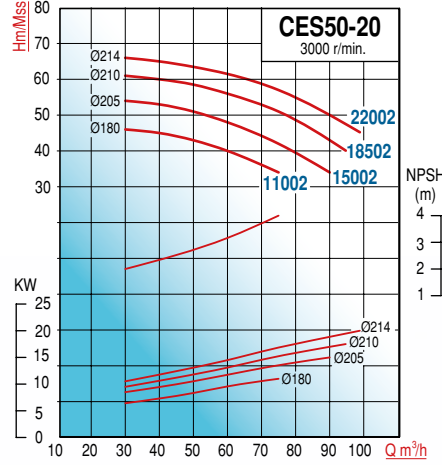
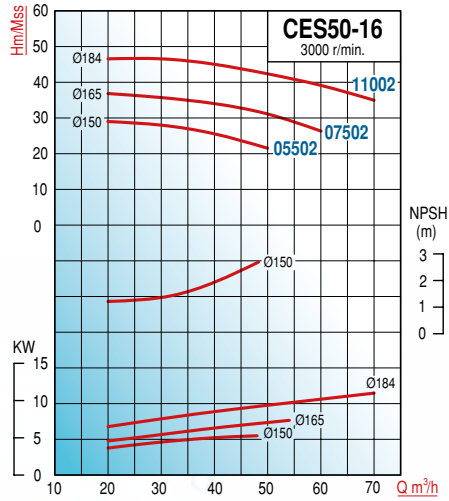

TİP TYPE	Boyutlar - Dimensions (mm)								Ağırlık - Weight	
	A	L	h1	h2	H	E	n1	n2	Kg	
CES50-16 05502	100	589	160	180	340	271	265	212	61	
CES50-16 07502	100	589	160	180	340	271	265	212	61	
CES50-16 11002	100	748	160	180	340	271	265	212	88	
CES50-20 11002	100	718	160	200	360	307	265	212	99	
CES50-20 15002	100	784	160	200	360	350	265	212	136	
CES50-20 18502	100	784	160	200	360	350	265	212	151	
CES50-20 22002	100	784	160	200	360	350	265	212	150	
CES50-26 18502	100	796	180	225	405	350	320	250	162	
CES50-26 22002	100	796	180	225	405	350	320	250	161	
CES50-26 30002	100	887	180	225	461	400	320	250	212	
CES50-26 37002	100	887	180	225	461	400	320	250	231	
CES50-32 30002	125	912	225	280	505	417	345	280	235	
CES50-32 37002	125	912	225	280	505	417	345	280	254	
CES50-32 45002	125	912	225	280	505	417	345	280	287	

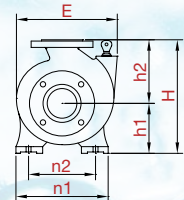
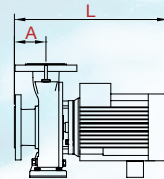

CES65 (3000 d/d)

MONOBLOK SALYANGOZ POMPALAR

VOLUTE CASING CLOSE-COUPLED PUMPS

TİP TYPE	Bağlantı Giriş x Çıkış Inlet x Outlet	MOTOR						m ³ /h	Debi (Q) - Capacity						FİYAT - PRICE (TL)			
		HP	kW	IEC	V	A	d/d		Hm (mSS)	Debi (Q) - Capacity						Tek Pompa Bare Pump	Şasesiz Excl. Base	Şaseli Incl. Base
										20	45	90	115	120	130			
CES65-13 04002	3" x 2.5"	5,5	4	100L	380	8	3000	Hm (mSS)	15	13	9	4	2		28.010 ₺	38.620 ₺	39.295 ₺	
CES65-13 05502		7.5	5,5	112M	380/660	10.9			18	16	12	7	5	1	28.010 ₺	39.960 ₺	40.635 ₺	
CES65-13 07502		10	7.5	112M		14.1			21	20	16	11	9	2	28.010 ₺	43.625 ₺	44.300 ₺	
CES65-13 11002		15	11	132M		21			24	23	20	15	13	6	28.445 ₺	55.565 ₺	56.240 ₺	

Flanşlar hariçtir. Takım fiyatı (Flange Set): 2.060 TL

TİP TYPE	Bağlantı Giriş x Çıkış Inlet x Outlet	MOTOR						m ³ /h	Debi (Q) - Capacity						FİYAT - PRICE (TL)			
		HP	kW	IEC	V	A	d/d		Hm (mSS)	Debi (Q) - Capacity						Tek Pompa Bare Pump	Şasesiz Excl. Base	Şaseli Incl. Base
										30	60	90	110	125	140			
CES65-16 07502	3" x 2.5"	10	7.5	112M	380/660	14.1	3000	Hm (mSS)	30	26	18	13	7		29.665 ₺	45.120 ₺	45.795 ₺	
CES65-16 11002		15	11	132M		21			36	33	26	22	17	5	30.780 ₺	55.235 ₺	55.910 ₺	
CES65-16 15002		20	15	160L		28			42	38	33	27	22	16	30.780 ₺	63.260 ₺	64.125 ₺	

Flanşlar hariçtir. Takım fiyatı (Flange Set): 2.060 TL

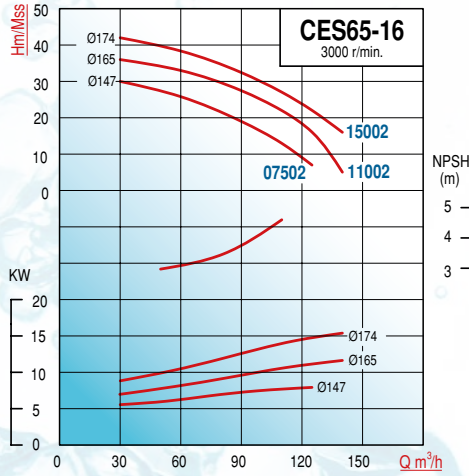
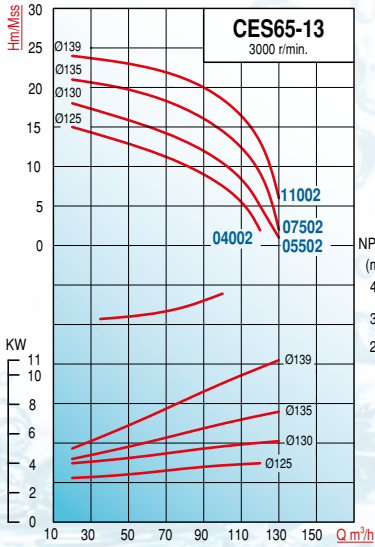

TİP TYPE	Boyutlar - Dimensions (mm)								Ağırlık - Weight
	A	L	h1	h2	H	E	n1	n2	Kg
CES65-13 04002	100	575	160	180	340	284	280	212	58
CES65-13 05502	100	575	160	180	340	284	280	212	64
CES65-13 07502	100	620	160	180	340	284	280	212	69
CES65-13 11002	100	681	160	180	340	284	280	212	87
CES65-16 07502	100	649	160	200	360	295	280	212	73
CES65-16 11002	100	709	160	200	360	295	280	212	94
CES65-16 15002	100	777	160	200	380	350	280	212	131

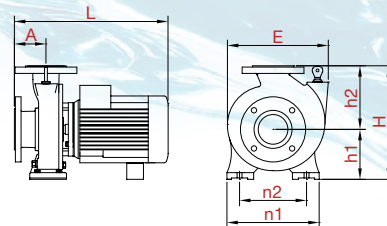

CES65 (3000 d/d) MONOBLOK SALYANGOZ POMPALAR

VOLUTE CASING CLOSE-COUPLED PUMPS

TİP TYPE	Bağlantı Giriş x Çıkış Inlet x Outlet	MOTOR						m ³ /h	Debi (Q) - Capacity						FİYAT - PRICE (TL)		
		HP	kW	IEC	V	A	d/d		Debi (Q) - Capacity						Tek Pompa Bare Pump	Şasesiz Excl. Base	Şaseli Incl. Base
									80	100	125	140	150	155			
CES65-20 15002	3" x 2.5"	20	15	160L	380/660	28	3000	Hm (mss)	33	31	27	20	11	2	33.750 ₺	70.115 ₺	70.975 ₺
CES65-20 18502		25	18,5	160L		34			44	40	34	28	22	15	33.750 ₺	74.370 ₺	75.235 ₺
CES65-20 22002		30	22	160L		40,5			48	44	38	32	26	17	33.750 ₺	84.430 ₺	85.295 ₺
CES65-20 30002		40	30	200L		56,6			57	53	48	43	36	25	35.145 ₺	115.865 ₺	117.000 ₺
CES65-20 37002		50	37	200L		68			63	61	56	50	44	31	35.145 ₺	125.350 ₺	126.485 ₺

Flanşlar hariçtir. Takım fiyatı (Flange Set): 2.060 TL

TİP TYPE	Bağlantı Giriş x Çıkış Inlet x Outlet	MOTOR						m ³ /h	Debi (Q) - Capacity						FİYAT - PRICE (TL)		
		HP	kW	IEC	V	A	d/d		Debi (Q) - Capacity						Tek Pompa Bare Pump	Şasesiz Excl. Base	Şaseli Incl. Base
									30	50	125	150	155	160			
CES65-26 22002	3" x 2.5"	30	22	160L	380/660	40,5	3000	Hm (mss)	59	58	43	25	17	2	36.460 ₺	86.880 ₺	88.015 ₺
CES65-26 30002		40	30	200L		54,6			65	64	52	39	32	12	37.840 ₺	118.300 ₺	119.435 ₺
CES65-26 37002		50	37	200L		68			81	80	67	55	50	40	37.840 ₺	127.785 ₺	128.920 ₺
CES65-26 45002		60	45	200L		83,8			91	90	88	72	66	60	37.840 ₺	135.680 ₺	136.815 ₺

Flanşlar hariçtir. Takım fiyatı (Flange Set): 2.060 TL

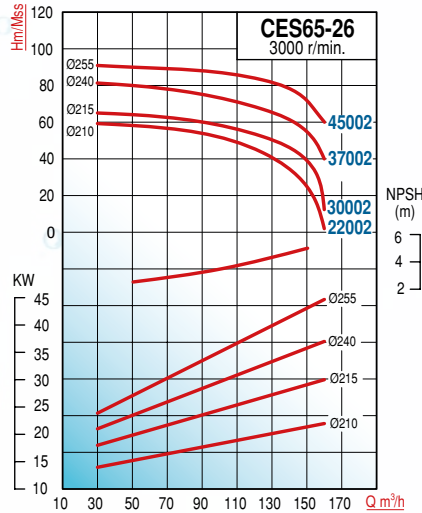
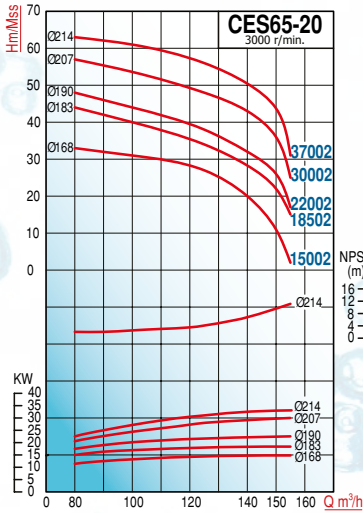

TİP TYPE	Boyutlar - Dimensions (mm)								Ağırlık - Weight
	A	L	h1	h2	H	E	n1	n2	Kg
CES65-20 15002	100	785	180	225	405	350	320	250	144
CES65-20 18502	100	785	180	225	405	350	320	250	159
CES65-20 22002	100	785	180	225	405	350	320	250	158
CES65-20 30002	100	867	180	225	461	400	320	250	210
CES65-20 37002	100	917	180	225	461	400	320	250	239
CES65-26 22002	100	756	200	250	450	354	360	280	169
CES65-26 30002	100	887	200	250	461	400	360	280	220
CES65-26 37002	100	887	200	250	461	400	360	280	220
CES65-26 45002	100	887	200	250	461	400	360	280	253

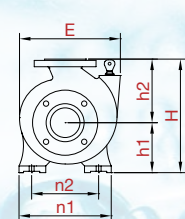
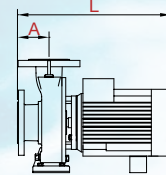

CES80 (3000 d/d)

MONOBLOK SALYANGOZ POMPALAR

VOLUTE CASING CLOSE-COUPLED PUMPS

TİP TYPE	Bağlantı Giriş x Çıkış Inlet x Outlet	MOTOR						Debi (Q) - Capacity m ³ /h	FİYAT - PRICE (TL)									
		HP	kW	IEC	V	A	d/d		Tek Pompa									
									Bare Pump	Şasesiz Excl. Base	Şaseli Incl. Base							
CES80-16 11002	4" x 3"	15	11	132M	380/660	21	3000	Hm (mSS)	70	100	130	160	190	220	31.845 ₺	56.195 ₺	57.060 ₺	
CES80-16 15002		20	15	160L					26,7	30	29	28	25	20	13	31.845 ₺	64.220 ₺	65.085 ₺
CES80-16 18502		25	18.5	160L					32,6	34	33	32	29	25	18	33.415 ₺	74.070 ₺	74.935 ₺
CES80-16 22002		30	22	160L					40,5	38	37	36	33	29	23	33.415 ₺	84.130 ₺	84.995 ₺

Flanşlar hariçtir. Takım fiyatı (Flange Set): 2.645 TL

TİP TYPE	Bağlantı Giriş x Çıkış Inlet x Outlet	MOTOR						Debi (Q) - Capacity m ³ /h	FİYAT - PRICE (TL)									
		HP	kW	IEC	V	A	d/d		Tek Pompa									
									Bare Pump	Şasesiz Excl. Base	Şaseli Incl. Base							
CES80-20 18502	4" x 3"	25	18.5	160L	380/660	32,6	3000	Hm (mSS)	90	120	150	180	210	240	35.455 ₺	75.910 ₺	77.045 ₺	
CES80-20 22002		30	22	160L					40,5	47	46	44	40	33	35.455 ₺	85.970 ₺	87.105 ₺	
CES80-20 30002		40	30	200L					54,6	53	52	50	46	40	32	36.920 ₺	117.475 ₺	118.610 ₺
CES80-20 37002		50	37	200L					67,5	58	57	55	52	47	40	36.920 ₺	126.960 ₺	128.095 ₺
CES80-20 45002		60	45	200L					83,8	64	63	62	59	54	46	36.920 ₺	134.850 ₺	135.985 ₺

Flanşlar hariçtir. Takım fiyatı (Flange Set): 2.645 TL

TİP TYPE	Bağlantı Giriş x Çıkış Inlet x Outlet	MOTOR						Debi (Q) - Capacity m ³ /h	FİYAT - PRICE (TL)									
		HP	kW	IEC	V	A	d/d		Tek Pompa									
									Bare Pump	Şasesiz Excl. Base	Şaseli Incl. Base							
CES80-26 30002	4" x 3"	40	30	200L	380/660	54,6	3000	Hm (mSS)	70	100	130	160	190	220	39.085 ₺	119.430 ₺	120.835 ₺	
CES80-26 37002		50	37	200L					68	64	63	61	57	49	35	39.470 ₺	129.265 ₺	130.670 ₺
CES80-26 45002		60	45	200L					83,8	70	69	67	63	57	48	39.470 ₺	137.155 ₺	138.560 ₺

Flanşlar hariçtir. Takım fiyatı (Flange Set): 2.645 TL

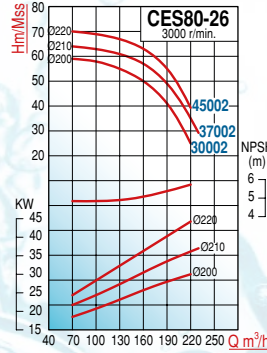
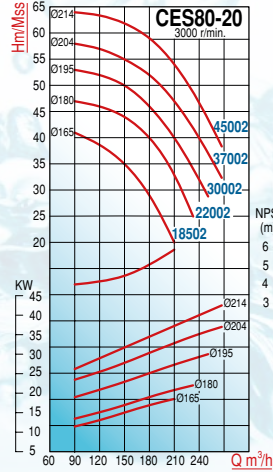
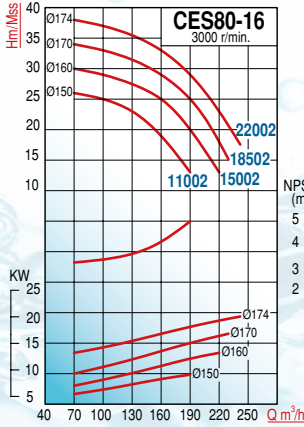

TİP TYPE	Boyutlar - Dimensions (mm)								Ağırlık - Weight Kg
	A	L	h1	h2	H	E	n1	n2	
CES80-16 11002	125	785	180	225	405	350	320	250	144
CES80-16 15002	125	785	180	225	405	350	320	250	159
CES80-16 18502	125	785	180	225	405	350	320	250	158
CES80-16 22002	125	867	180	225	461	400	320	250	210
CES80-16 30002	125	756	200	250	450	354	360	280	169
CES80-20 18502	125	887	200	250	461	400	360	280	220
CES80-20 22002	125	887	200	250	461	400	360	280	220
CES80-20 30002	125	887	200	250	461	400	360	280	220
CES80-20 37002	125	887	200	250	461	400	360	280	220
CES80-20 45002	125	887	200	250	461	400	360	280	253
CES80-26 30002	125	887	200	250	461	400	360	280	220
CES80-26 37002	125	887	200	250	461	400	360	280	220
CES80-26 45002	125	887	200	250	461	400	360	280	253

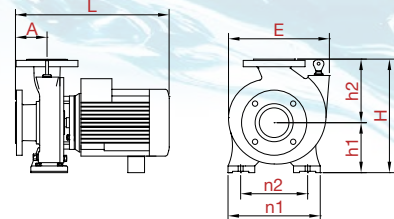

CES100 (3000 d/d)

MONOBLOK SALYANGOZ POMPALAR

VOLUTE CASING CLOSE-COUPLED PUMPS

TİP TYPE	Bağlantı Giriş x Çıkış Inlet x Outlet	MOTOR						m ³ /h	Debi (Q) - Capacity						FİYAT - PRICE (TL)		
		HP	kW	IEC	V	A	d/p		Debi (Q) - Capacity						Tek Pompa Bare Pump	Şasesiz Excl. Base	Şaseli Incl. Base
									120	160	200	240	280	320			
CES100-20 30002	5" x 4"	40	30	200L	380/660	54,6	3000	Hm (mSS)	43	41	38	34.5	30	24	39.140 ₺	119.480 ₺	120.615 ₺
CES100-20 37002		50	37	200L		67,5			49	47	44	40.5	36	30	39.140 ₺	128.965 ₺	130.100 ₺
CES100-20 45002		60	45	200L		83,8			55	53	51	47	42	35	39.140 ₺	136.855 ₺	137.990 ₺

Flanşlar hariçtir. Takım fiyatı (Flange Set): 3.235 TL

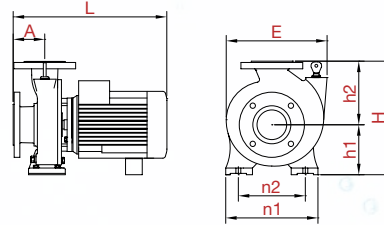
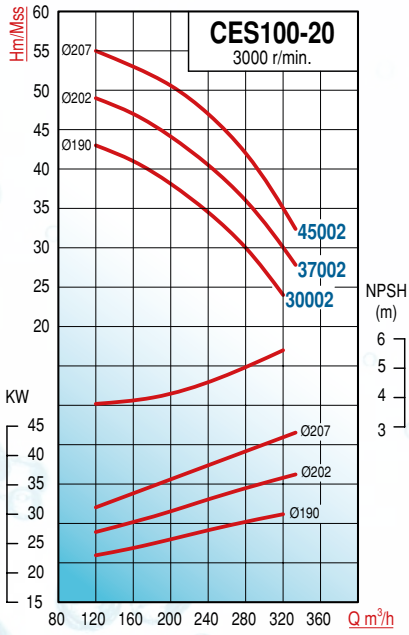

TİP TYPE	Boyutlar - Dimensions (mm)							Ağırlık - Weight	
	A	L	h1	h2	H	E	n1	n2	Kg
CES100-20 30002	125	904	200	280	480	400	360	280	224
CES100-20 37002	125	904	200	280	480	400	360	280	224
CES100-20 45002	125	904	200	280	480	400	360	280	257

CES40 (1500 d/d) MONOBLOK SALYANGOZ POMPALAR

1500 d/d

VOLUTE CASING CLOSE-COUPLED PUMPS

TİP TYPE	Bağlantı Giriş x Çıkış Inlet x Outlet	MOTOR						m ³ /h	Debi (Q) - Capacity						FİYAT - PRICE (TL)		
		HP	kW	IEC	V	A	d/d		Debi (Q) - Capacity						Tek Pompa Bare Pump	Şasesiz Excl. Base	Şaseli Incl. Base
									4	8	12	15	18	23			
CES40-16 00554	2.5"x1.5"	0,75	0,55	80M	380	1,45	1500	Hm (mSS)	8,5	8	7,5	6,5	2		24.010 ₺	29.620 ₺	30.295 ₺
CES40-16 00754		1	0,75	80M		1,9			11	10,5	10	9	8	3	24.010 ₺	30.980 ₺	31.655 ₺
CES40-16 01104		1,5	1,1	80M		2,6			12,5	12	11,5	11	10,5	8,5	24.010 ₺	32.375 ₺	33.050 ₺

Flanşlar hariçtir. Takım fiyatı (Flange Set): 1.515 TL

TİP TYPE	Bağlantı Giriş x Çıkış Inlet x Outlet	MOTOR						m ³ /h	Debi (Q) - Capacity						FİYAT - PRICE (TL)		
		HP	kW	IEC	V	A	d/d		Debi (Q) - Capacity						Tek Pompa Bare Pump	Şasesiz Excl. Base	Şaseli Incl. Base
									8	12	14	16	18	20			
CES40-20 00754	2.5"x1.5"	1	0,75	80M	380	1,9	1500	Hm (mSS)	10	9,5	9	8	7		27.505 ₺	31.640 ₺	32.320 ₺
CES40-20 01104		1,5	1,1	80M		2,6			13,5	13	12,5	11,5	10,5	9	27.505 ₺	33.115 ₺	33.795 ₺
CES40-20 01504		2	1,5	90L		3,5			16	15,5	15	14	13	11,5	27.505 ₺	34.545 ₺	35.220 ₺

Flanşlar hariçtir. Takım fiyatı (Flange Set): 1.515 TL

TİP TYPE	Bağlantı Giriş x Çıkış Inlet x Outlet	MOTOR						m ³ /h	Debi (Q) - Capacity						FİYAT - PRICE (TL)		
		HP	kW	IEC	V	A	d/d		Debi (Q) - Capacity						Tek Pompa Bare Pump	Şasesiz Excl. Base	Şaseli Incl. Base
									9	12	15	18	23	25			
CES40-26 01104	2.5"x1.5"	1,5	1,1	80M	380	1,9	1500	Hm (mSS)	12	11,5	11	10			30.220 ₺	35.570 ₺	36.435 ₺
CES40-26 01504		2	1,5	90L		3,5			16	15	14,5	13,5	11		30.220 ₺	36.995 ₺	37.860 ₺
CES40-26 02204		3	2,2	90L		4,8			20	19,5	19	18	15,5		30.220 ₺	39.120 ₺	39.985 ₺
CES40-26 03004		4	3	100L		6,6			24,5	24	23,5	22,5	19,5	18	30.220 ₺	40.650 ₺	41.515 ₺

Flanşlar hariçtir. Takım fiyatı (Flange Set): 1.515 TL

TİP TYPE	Bağlantı Giriş x Çıkış Inlet x Outlet	MOTOR						m ³ /h	Debi (Q) - Capacity						FİYAT - PRICE (TL)		
		HP	kW	IEC	V	A	d/d		Debi (Q) - Capacity						Tek Pompa Bare Pump	Şasesiz Excl. Base	Şaseli Incl. Base
									10	14	18	22	26	30			
CES40-32 02204	2.5"x1.5"	3	2,2	90L	380	5,1	1500	Hm (mSS)	20	19	17	14			36.130 ₺	44.575 ₺	45.440 ₺
CES40-32 03004		4	3	100L		6,6			26	25	23	20,5	16		36.130 ₺	46.105 ₺	46.970 ₺
CES40-32 04004		5,5	4	100L	380/660	8,3			31	30	28,5	26	23	17	36.130 ₺	50.525 ₺	51.390 ₺
CES40-32 05504		7,5	5,5	112M		14,1			38	37	35	32	28	23	36.130 ₺	53.620 ₺	54.485 ₺

Flanşlar hariçtir. Takım fiyatı (Flange Set): 1.515 TL



CES40 (1500 d/d)

MONOBLOK SALYANGOZ POMPALAR

VOLUTE CASING CLOSE-COUPLED PUMPS

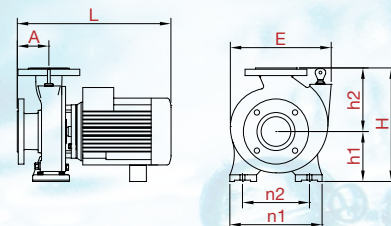
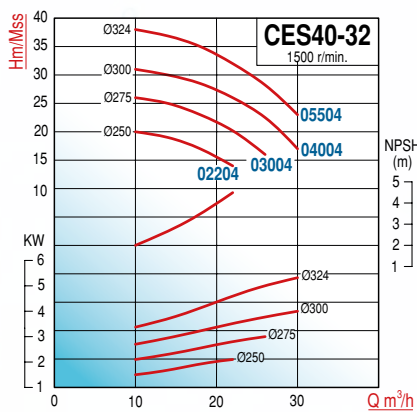
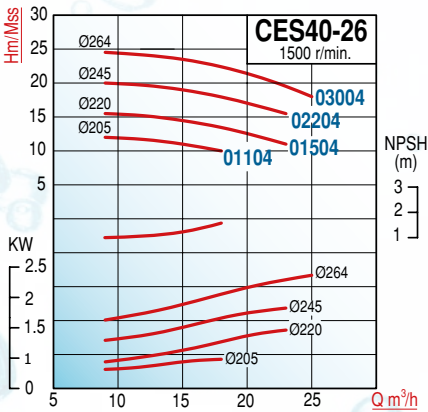
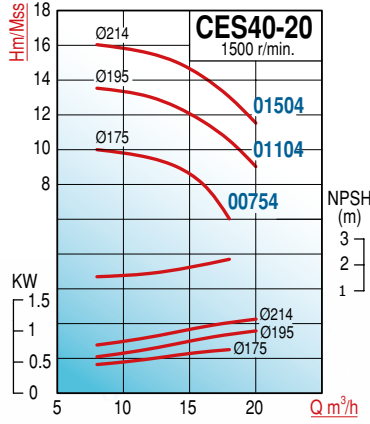
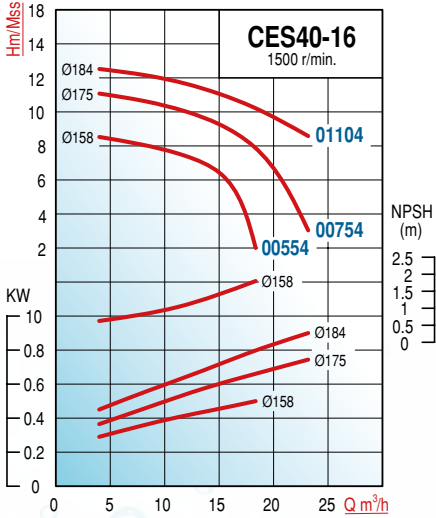
1500 d/d

TİP TYPE	Boyutlar - Dimensions (mm)							
	A	h1	h2	H	E	n1	n2	L
CES40-16 00554	80	132	160	292	246	240	190	472
CES40-16 00754	80	132	160	292	246	240	190	472
CES40-16 01104	80	132	160	292	246	240	190	472
CES40-20 00754	100	160	175	340	277	265	212	486
CES40-20 01104	100	160	175	340	277	265	212	486
CES40-20 01504	100	160	175	340	277	265	212	509
CES40-26 01104	100	180	225	405	350	320	250	487
CES40-26 01504	100	180	225	405	350	320	250	510
CES40-26 02204	100	180	225	405	350	320	250	539
CES40-26 03004	100	180	225	405	350	320	250	535
CES40-32 02204	125	200	250	461	400	345	280	593
CES40-32 03004	125	200	250	461	400	345	280	593
CES40-32 04004	125	200	250	461	400	345	280	621
CES40-32 05504	125	200	250	461	400	345	280	668

CE550 (1500 d/d) MONOBLOK SALYANGOZ POMPALAR

1500 d/d

VOLUTE CASING CLOSE-COUPLED PUMPS

TİP TYPE	Bağlantı Giriş x Çıkış Inlet x Outlet	MOTOR						d/d	m ³ /h	Debi (Q) - Capacity						FİYAT - PRICE (TL)		
		HP	kW	IEC	V	A	Hm (mSS)			Debi (Q) - Capacity						Tek Pompa Bare Pump	Şasesiz Excl. Base	Şaseli Incl. Base
										5	10	15	20	25	30			
CE550-16 00754	2.5"x 2"	1	0,75	80M	380	1,9	1500	Hm (mSS)	8,5	8	8	7	6		22.175 ₺	29.150 ₺	30.015 ₺	
CE550-16 01104		1,5	1,1	90L		2,6			10	10	9,5	9	8,5	7,5	22.175 ₺	30.540 ₺	31.405 ₺	
CE550-16 01504		2	1,5	90L		3,5			11,5	11,5	11	10,5	9,5	9	22.175 ₺	31.965 ₺	32.830 ₺	

Flanşlar hariçtir. Takım fiyatı (Flange Set): 1.620 TL

TİP TYPE	Bağlantı Giriş x Çıkış Inlet x Outlet	MOTOR						d/d	m ³ /h	Debi (Q) - Capacity						FİYAT - PRICE (TL)		
		HP	kW	IEC	V	A	Hm (mSS)			Debi (Q) - Capacity						Tek Pompa Bare Pump	Şasesiz Excl. Base	Şaseli Incl. Base
										15	20	25	30	35	40			
CE550-20 01104	2.5"x2"	1,5	1,1	90L	380	2,6	1500	Hm (mSS)	10,5	10	9	8			28.385 ₺	33.910 ₺	34.585 ₺	
CE550-20 01504		2	1,5	90L		3,5			12,5	12	11,5	10,5	9,5	28.385 ₺	35.340 ₺	36.015 ₺		
CE550-20 02204		3	2,2	90L		5,1			15	14,5	14	13,5	12,5	11	28.385 ₺	37.460 ₺	38.140 ₺	

Flanşlar hariçtir. Takım fiyatı (Flange Set): 1.620 TL

TİP TYPE	Bağlantı Giriş x Çıkış Inlet x Outlet	MOTOR						d/d	m ³ /h	Debi (Q) - Capacity						FİYAT - PRICE (TL)		
		HP	kW	IEC	V	A	Hm (mSS)			Debi (Q) - Capacity						Tek Pompa Bare Pump	Şasesiz Excl. Base	Şaseli Incl. Base
										15	25	30	35	40	50			
CE550-26 02204	2.5"x2"	3	2,2	90L	380	4,8	1500	Hm (mSS)	15,5	14,5	13	11			30.640 ₺	39.500 ₺	40.365 ₺	
CE550-26 03004		4	3	100L		6,6			19,5	19	18	16,5	14,5	30.640 ₺	41.030 ₺	41.895 ₺		
CE550-26 04004		5,5	4	100L	380/660	8,3			22,5	22	21,5	21	20	17	30.640 ₺	44.125 ₺	44.990 ₺	
CE550-26 05504		7,5	5,5	112M		14,1			24,5	24	23,5	23	22	19	30.640 ₺	47.220 ₺	48.085 ₺	

Flanşlar hariçtir. Takım fiyatı (Flange Set): 1.620 TL

TİP TYPE	Bağlantı Giriş x Çıkış Inlet x Outlet	MOTOR						d/d	m ³ /h	Debi (Q) - Capacity						FİYAT - PRICE (TL)		
		HP	kW	IEC	V	A	Hm (mSS)			Debi (Q) - Capacity						Tek Pompa Bare Pump	Şasesiz Excl. Base	Şaseli Incl. Base
										15	25	35	45	55	65			
CE550-32 04004	2.5"x2"	5,5	4	100L	380	8,3	1500	Hm (mSS)	25	24	22	19,5	16		36.680 ₺	51.025 ₺	51.890 ₺	
CE550-32 05504		7,5	5,5	112M		14,1			29	28	26,5	24	21	36.680 ₺	54.120 ₺	54.985 ₺		
CE550-32 07504		10	7,5	132M	380/660	15,7			34	33	31	29	26	22	37.795 ₺	58.135 ₺	59.000 ₺	
CE550-32 11004		15	11	132M		21,6			37	36	34,5	32	29,5	25	37.795 ₺	69.525 ₺	70.390 ₺	

Flanşlar hariçtir. Takım fiyatı (Flange Set): 1.620 TL



CES50 (1500 d/d) MONOBLOK SALYANGOZ POMPALAR

VOLUTE CASING CLOSE-COUPLED PUMPS

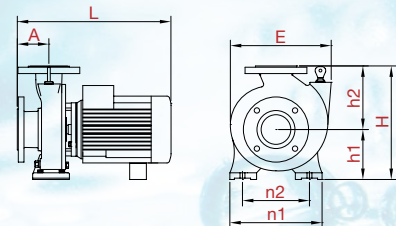
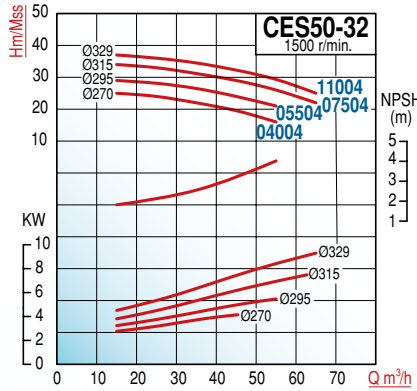
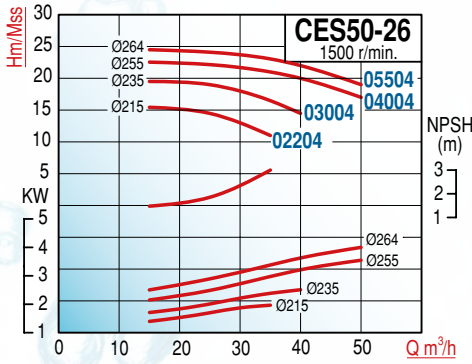
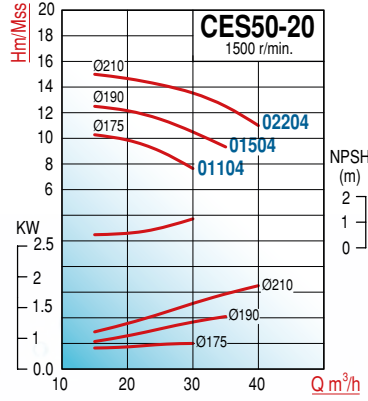
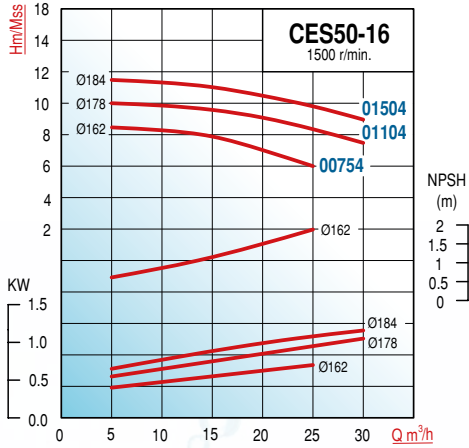
1500 d/d

TİP TYPE	Boyutlar - Dimensions (mm)							
	A	h1	h2	H	E	n1	n2	L
CES50-16 00754	100	160	180	340	271	265	212	513
CES50-16 01104	100	160	180	340	271	265	212	513
CES50-16 01504	100	160	180	340	271	265	212	554
CES50-20 01104	100	160	200	360	303	265	212	490
CES50-20 01504	100	160	200	360	303	265	212	513
CES50-20 02204	100	160	200	360	303	265	212	541
CES50-20 02204	100	180	225	405	350	320	250	540
CES50-26 03004	100	180	225	405	350	320	250	536
CES50-26 04004	100	180	225	405	350	320	250	564
CES50-26 05504	100	180	225	405	350	320	250	611
CES50-32 04004	125	225	280	505	417	345	280	624
CES50-32 05504	125	225	280	505	417	345	280	671
CES50-32 07504	125	225	280	505	417	345	280	692
CES50-32 11004	125	225	280	505	417	345	280	719

CES65 (1500 d/d)

MONOBLOK SALYANGOZ POMPALAR

1500 d/d

VOLUTE CASING CLOSE-COUPLED PUMPS

TİP TYPE	Bağlantı Giriş x Çıkış Inlet x Outlet	MOTOR						m ³ /h	Debi (Q) - Capacity						FİYAT - PRICE (TL)		
		HP	kW	IEC	V	A	d/d		15	30	45	60	75	90	Tek Pompa	Şasesiz	Şaseli
		Bare Pump	Excl. Base	Incl. Base													
CES65-20 01504	3"x2.5"	2	1,5	90L	380	3,5	1500	Hm (mSS)	9	8,5	7	5			30.060 ₺	36.855 ₺	37.770 ₺
CES65-20 02204		3	2,2	90L		5,1		11	10,5	9,5	7,5			30.060 ₺	38.975 ₺	39.895 ₺	
CES65-20 03004		4	3	100L		6,6		14	13,5	12,5	11	8,5			30.060 ₺	40.505 ₺	41.425 ₺
CES65-20 04004		5,5	4	100L		8,3		16	15,5	14,5	13	11	8		30.060 ₺	43.600 ₺	44.520 ₺

Flanşlar hariçtir. Takım fiyatı (Flange Set): 2.060 TL

TİP TYPE	Bağlantı Giriş x Çıkış Inlet x Outlet	MOTOR						m ³ /h	Debi (Q) - Capacity						FİYAT - PRICE (TL)		
		HP	kW	IEC	V	A	d/d		20	35	45	55	65	75	Tek Pompa	Şasesiz	Şaseli
		Bare Pump	Excl. Base	Incl. Base													
CES65-26 03004	3"x2.5"	4	3	100L	380/660	6,6	1500	Hm (mSS)	16	15,5	14,5	12,5			32.535 ₺	42.740 ₺	43.605 ₺
CES65-26 04004		5,5	4	100L		8,3		19,5	19	17,5	16	14		32.535 ₺	45.835 ₺	46.700 ₺	
CES65-26 05504		7,5	5,5	112M		14,1		22,5	22	21	20	19	17,5	32.535 ₺	48.930 ₺	49.795 ₺	
CES65-26 07504		10	7,5	132M		15,7		25	24,5	24	23	22	20	34.035 ₺	54.740 ₺	55.605 ₺	

Flanşlar hariçtir. Takım fiyatı (Flange Set): 2.060 TL

TİP TYPE	Bağlantı Giriş x Çıkış Inlet x Outlet	MOTOR						m ³ /h	Debi (Q) - Capacity						FİYAT - PRICE (TL)		
		HP	kW	IEC	V	A	d/d		30	45	60	75	90	105	Tek Pompa	Şasesiz	Şaseli
		Bare Pump	Excl. Base	Incl. Base													
CES65-32 05504	3"x2.5"	7,5	5,5	112M	380/660	14,1	1500	Hm (mSS)	22	21	19	15			39.285 ₺	56.475 ₺	57.340 ₺
CES65-32 07504		10	7,5	132M		15,7		27,5	27	25,5	22,5	15		40.445 ₺	60.530 ₺	61.395 ₺	
CES65-32 11004		15	11	132M		22,8		34	33	31	28	22,5	13	40.445 ₺	71.920 ₺	72.785 ₺	
CES65-32 15004		15	20	132M		29,8		37,5	36,5	35	32,5	27,5	20	42.975 ₺	84.100 ₺	84.965 ₺	

Flanşlar hariçtir. Takım fiyatı (Flange Set): 2.060 TL

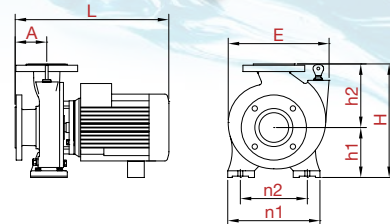
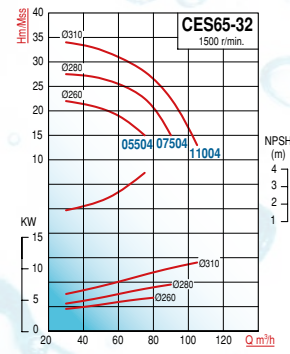
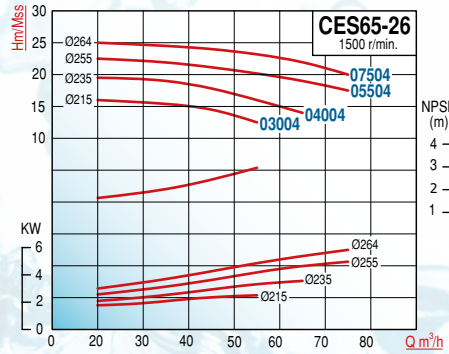
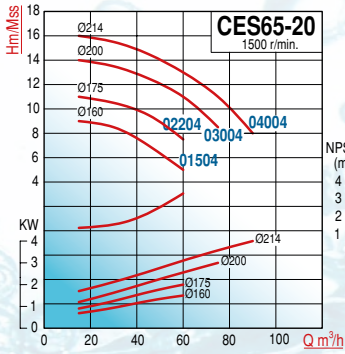

TİP TYPE	Boyutlar - Dimensions (mm)							
	A	h1	h2	H	E	n1	n2	L
CES65-20 01504	100	180	225	405	320	320	250	517
CES65-20 02204	100	180	225	405	320	320	250	545
CES65-20 03004	100	180	225	405	320	320	250	542
CES65-20 04004	100	180	225	405	320	320	250	586
CES65-26 03004	100	200	250	450	354	360	280	535
CES65-26 04004	100	200	250	450	354	360	280	563
CES65-26 05504	100	200	250	450	354	360	280	610
CES65-26 07504	100	200	250	450	354	360	280	665
CES65-32 05504	125	225	280	505	415	400	315	679
CES65-32 07504	125	225	280	505	415	400	315	708
CES65-32 11004	125	225	280	505	415	400	315	735

CES80 (1500 d/d) MONOBLOK SALYANGOZ POMPALAR

VOLUTE CASING CLOSE-COUPLED PUMPS

1500 d/d

TİP TYPE	Bağlantı Giriş x Çıkış Inlet x Outlet	MOTOR					d/d	m ³ /h	Debi (Q) - Capacity						FİYAT - PRICE (TL)		
		HP	kW	IEC	V	A			40	55	70	85	100	115	Tek Pompa Bare Pump	Şasesiz Excl. Base	Şaseli Incl. Base
CES80-20 03004	4"x3"	4	3	100L	380	6,6	1500	Hm (mSS)	11	10,5	10	9	7,5		31.620 ₺	41.920 ₺	42.785 ₺
CES80-20 04004		5,5	4	100L	380/	8,3			13	12,5	12	11,5	10,5		31.620 ₺	45.010 ₺	45.875 ₺
CES80-20 05504		7,5	5,5	112M	660	14,1			15,5	15	14,5	14	13	12	31.620 ₺	48.110 ₺	48.975 ₺

Flaşlar hariçtir. Takım fiyatı (Flange Set): 2.645 TL

TİP TYPE	Bağlantı Giriş x Çıkış Inlet x Outlet	MOTOR					d/d	m ³ /h	Debi (Q) - Capacity						FİYAT - PRICE (TL)		
		HP	kW	IEC	V	A			40	60	80	100	115	130	Tek Pompa Bare Pump	Şasesiz Excl. Base	Şaseli Incl. Base
CES80-26 04004	4"x3"	5,5	4	100L	380/	8,3	1500	Hm (mSS)	15	14,5	13,5				34.165 ₺	47.310 ₺	48.175 ₺
CES80-26 05504		7,5	5,5	112M		11,4			17,5	17	16	15	13		34.165 ₺	50.405 ₺	51.270 ₺
CES80-26 07504		10	7,5	132M		15,7			21,5	21	20	18,5	16,5	14	35.670 ₺	56.215 ₺	57.080 ₺
CES80-26 11004		15	11	132M		21,6			24,5	24	23,5	22	20,5	18,5	35.670 ₺	67.600 ₺	68.465 ₺

Flaşlar hariçtir. Takım fiyatı (Flange Set): 2.645 TL

TİP TYPE	Bağlantı Giriş x Çıkış Inlet x Outlet	MOTOR					d/d	m ³ /h	Debi (Q) - Capacity						FİYAT - PRICE (TL)		
		HP	kW	IEC	V	A			40	60	80	100	130	160	Tek Pompa Bare Pump	Şasesiz Excl. Base	Şaseli Incl. Base
CES80-32 07504	4"x3"	10	7,5	132M	380/	15,7	1500	Hm (mSS)	23	22	20	16			38.795 ₺	59.040 ₺	59.905 ₺
CES80-32 11004		15	11	132M		21,6			30	29	27	25	19		38.795 ₺	70.430 ₺	71.295 ₺
CES80-32 15004		20	15	160L		29,8			35	34	33	31	27	21	41.325 ₺	82.610 ₺	83.475 ₺
CES80-32 18504		25	18,5	160L		35,8			37,5	37	36	35	32	26	41.325 ₺	89.185 ₺	90.050 ₺

Flaşlar hariçtir. Takım fiyatı (Flange Set): 2.645 TL

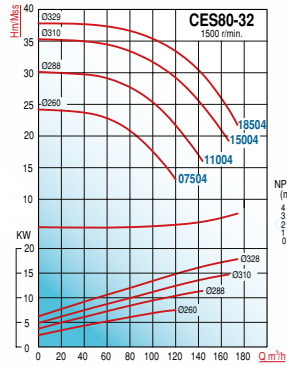
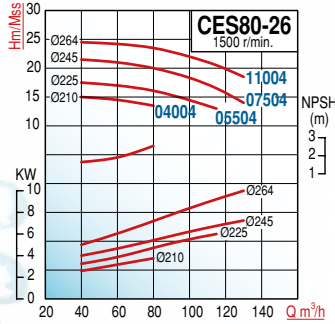
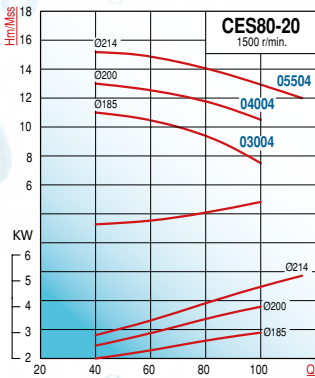

TİP TYPE	Boyutlar - Dimensions (mm)							
	A	h1	h2	H	E	n1	n2	L
CES80-20 03004	125	180	250	430	385	345	280	567
CES80-20 04004	125	180	250	430	385	345	280	611
CES80-20 05504	125	180	250	430	385	345	280	611
CES80-26 04004	125	200	280	480	420	400	315	589
CES80-26 05504	125	200	280	480	420	400	315	636
CES80-26 07504	125	200	280	480	420	400	315	691
CES80-26 11004	125	200	280	480	420	400	315	718
CES80-32 07504	125	250	315	565	445	400	315	717
CES80-32 11004	125	250	315	565	445	400	315	717
CES80-32 15004	125	250	315	565	445	400	315	821
CES80-32 18504	125	250	315	565	445	400	315	874

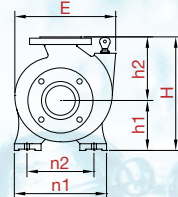
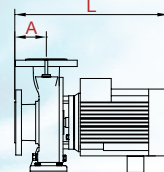

CES100 (1500 d/d)

MONOBLOK SALYANGOZ POMPALAR

1500 d/d

VOLUTE CASING CLOSE-COUPLED PUMPS

TİP TYPE	Bağlantı Giriş x Çıkış Inlet x Outlet	MOTOR						d/d	m ³ /h	Debi (Q) - Capacity						FİYAT - PRICE (TL)		
		HP	kW	IEC	V	A	50			80	110	140	160	180	Tek Pompa	Şasesiz	Şaseli	
		Bare Pump	Excl. Base	Incl. Base														
CES100-20 03004	5"x4"	4	3	100L	380	6,6	1500	Hm (mSS)	9,5	9	8	6,5			33.840 ₺	43.925 ₺	44.790 ₺	
CES100-20 04004		5,5	4	100L	380/	8,3			12	11,5	10,5	8,5	7			33.840 ₺	47.015 ₺	47.880 ₺
CES100-20 05504		7,5	5,5	112M	660	14,1			14	13,5	13	11,5	10	8,5			33.840 ₺	50.115 ₺

Flanşlar hariçtir. Takım fiyatı (Flange Set): 3.235 TL

TİP TYPE	Bağlantı Giriş x Çıkış Inlet x Outlet	MOTOR						d/d	m ³ /h	Debi (Q) - Capacity						FİYAT - PRICE (TL)				
		HP	kW	IEC	V	A	75			100	125	150	175	200	Tek Pompa	Şasesiz	Şaseli			
		Bare Pump	Excl. Base	Incl. Base																
CES100-26 05504	5"x4"	7,5	5,5	112M	380/660	14,1	1500	Hm (mSS)	15	14	12					36.390 ₺	52.415 ₺	53.280 ₺		
CES100-26 07504		10	7,5	132M		15,7			17,5	17	16	14					37.890 ₺	58.225 ₺	59.090 ₺	
CES100-26 11004		15	11	132M		21,6			21,5	21	20,5	19,5	18					37.890 ₺	69.610 ₺	70.475 ₺
CES100-26 15004		20	15	160L		29,8			25	24,5	24	23	22	20				39.995 ₺	81.410 ₺	82.275 ₺

Flanşlar hariçtir. Takım fiyatı (Flange Set): 3.235 TL

TİP TYPE	Bağlantı Giriş x Çıkış Inlet x Outlet	MOTOR						d/d	m ³ /h	Debi (Q) - Capacity						FİYAT - PRICE (TL)					
		HP	kW	IEC	V	A	100			125	150	175	200	220	Tek Pompa	Şasesiz	Şaseli				
		Bare Pump	Excl. Base	Incl. Base																	
CES100-32 11004	5"x4"	15	11	132M	380/660	21,6	1500	Hm (mSS)	23	21	18	16				40.295 ₺	71.785 ₺	72.650 ₺			
CES100-32 15004		20	15	160L		29,8			26	25	24	22	17					42.825 ₺	83.965 ₺	85.100 ₺	
CES100-32 18504		25	18,5	160L		35,8			32	29	28	26	24	23					42.825 ₺	90.535 ₺	91.670 ₺
CES100-32 22004		30	22	160L		42,1			35	33	32	30	27	26					43.155 ₺	107.610 ₺	108.745 ₺
CES100-32 30004		40	30	200L		57,3			36	35	33	32	29	27					44.455 ₺	121.495 ₺	122.630 ₺

Flanşlar hariçtir. Takım fiyatı (Flange Set): 3.235 TL

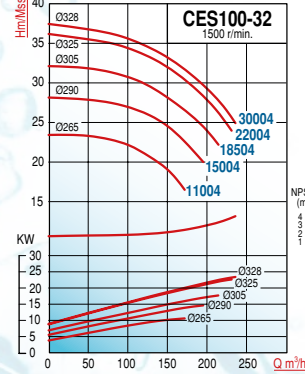
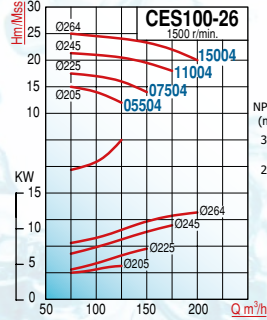
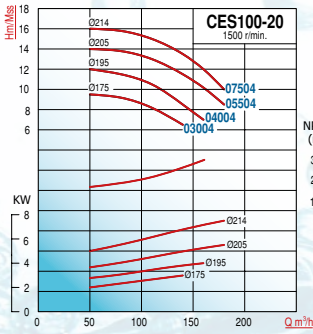

TİP TYPE	Boyutlar - Dimensions (mm)							
	A	h1	h2	H	E	n1	n2	L
CES100-20 03004	125	200	280	480	385	360	280	574
CES100-20 04004	125	200	280	480	385	360	280	618
CES100-20 05504	125	200	280	480	385	360	280	618
CES100-26 05504	140	225	280	505	420	400	315	660
CES100-26 07504	140	225	280	505	420	400	315	715
CES100-26 11004	140	225	280	505	420	400	315	742
CES100-26 15004	140	225	280	505	420	400	315	846
CES100-32 11004	140	250	315	565	485	400	315	728
CES100-32 15004	140	250	315	565	485	400	315	831
CES100-32 18504	140	250	315	565	485	400	315	884
CES100-32 22004	140	250	315	565	485	400	315	884
CES100-32 30004	140	250	315	565	485	400	315	920

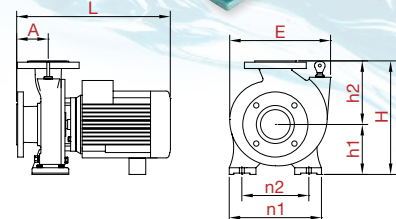

CES-i SERİSİ (3000 d/d & 1500 d/d) HAT TIPI (INLINE) SANTRİFÜJ POMPALAR

INLINE CENTRIFUGAL PUMPS



TEKNİK ÖZELLİKLER

- Motor: IE3 Sınıfı (Yüksek Verimli, Enerji Tasarruflu)
- Kapasite: 10 - 150 m³/h
- Basma Yüksekliği: 5 - 46 m
- Devir Hızı: 3000 d/d ve 1500 d/d
- Sıvı Sıcaklığı: -10 °C ~ +105 °C
- Flanslar TS EN 1092 - 2 / PN 16' ya uygundur.
- Giriş Flansları: DN50 - DN100
- Çıkış Flansları: DN50 - DN100
- İzolasyon sınıfı: F
- Koruma sınıfı: IP55
- Pompa Mili IEC ölçülerine uygun Genel maksat tip motorlara geçme şeklinde akuplaj yapılmıştır. Bu şekil akuplaj Pompa ve Motor milinin aynı hızda olmasını sağlar. Böylece çarkın dinamik ve statik olarak dengede çalışması sağlanır.
- Yataklama: Pompa Mili, Arapça (3000 d/d)denge rulmanı ve motor rulmanları tarafından yataklanır.
- Eksenel yük dengeleme delikleri ile dengelenir.

MALZEME ÖZELLİKLERİ

- Çark: PİK GG-25 PİK Döküm
- Gövde: GG-25 PİK Döküm
- Mil: X20Cr13 (AISI420) Opsiyonel: AISI316 çelik
- Sızdırmazlık: Mekanik salmastra (Karbon-Silisyum/Viton)
- Aşınma Halkası: GG-25 PİK Döküm

KULLANIM ALANLARI

- Soğutma & Isıtma sistemleri
- Sirkülasyon
- Buhar kazanları besli, kondens sistemleri
- Endüstriyel tesisler
- Hidrofor sistemleri
- Yangın söndürme sistemleri

OPSİYONEL

- Açık Çark
- Bronz Çark
- AISI 316 / AISI 304 Çelik Mil

TECHNICAL DATA

- Motor: IE3 Class (High Efficiency, Energy Saving)
- Capacity: 10 - 150 m³/h
- Total Head: 5 - 46
- Rotation Speed: 3000 rpm and 1500 rpm
- Liquid Temp.: -10°C ~ +105°C
- Suction and discharge flanges conform to EN 1092-2 / PN 16
- Inlet Flanges: DN50 - DN100
- Outlet Flanges: DN50 - DN100
- Insulation Class: F
- Protection Class: IP55
- CES series are designed to be driven by IEC standard motor. Pump shaft and motor shaft are close-coupled design. This way of coupling ensures the alignment of pump and motor. Therefore impeller runs in good balance both dynamically and statically.
- Bearing: Pump Shaft is supported by the ball bearing on pump support also by the ball bearings on electric motor (3000 d/d)
- Axial load is reduced by balance holes

MATERIAL SPECIFICATIONS

- Impellers: Cast iron GG-25
- Body: Cast iron GG-25
- Pump Shaft: X20Cr13 (AISI420) steel, Optional: AISI316 stainless steel.
- Non-Leakage: Mechanical seal (Carbon/Sic/Viton)
- Wear Ring: Cast iron GG-25

APPLICATIONS

- Chiller & Heating systems
- Circulation
- Boiler feeding, condens systems
- Industry
- Booster systems
- Fire fighting systems

OPTIONAL

- Open Impeller
- Bronze Impeller
- AISI 316 / AISI 304 S/S Shaft

CES-i40 (3000 d/d) HAT TIPI (INLINE) SANTRİFÜJ POMPALAR

INLINE CENTRIFUGAL PUMPS

TİP TYPE	Bağlantı Giriş x Çıkış Inlet x Outlet	MOTOR				m ³ /h Hm (mss)	Debi (Q) - Capacity						FİYAT - PRICE (TL)				
		HP	kW	V	A		d/d	1	10	12	15	20	25	Tek Pompa	Şasesiz	Şaseli	
								Bare Pump	Excl. Base	Incl. Base							
CES-i40-13 01102	1,5" x 1,5"	1,5	1,1	380/660	2,4	3000	18	15	13,5	10,5			27.310 ₺	30.380 ₺	30.485 ₺		
CES-i40-13 01502		2	1,5		3,3		21	19	17,5	15	9,5			27.310 ₺	31.690 ₺	31.795 ₺	
CES-i40-13 02202		3	2,2		4,3		27	25,5	25	23	18	12,5			27.410 ₺	33.645 ₺	33.750 ₺
CES-i40-13 03002		4	3		6,3		30	29	28	26,5	22,5	17			27.410 ₺	35.230 ₺	35.330 ₺

Flanşlar hariçtir. Takım fiyatı (Flange Set): 1.325 TL

TİP TYPE	Bağlantı Giriş x Çıkış Inlet x Outlet	MOTOR				m ³ /h Hm (mss)	Debi (Q) - Capacity						FİYAT - PRICE (TL)				
		HP	kW	V	A		d/d	10	12	14	18	20	22	Tek Pompa	Şasesiz	Şaseli	
								Bare Pump	Excl. Base	Incl. Base							
CES-i40-16 03002	1,5" x 1,5"	4	3	380/660	6,3	3000	32	31	28	22			28.275 ₺	36.950 ₺	37.055 ₺		
CES-i40-16 04002		5,5	4		7,75		40	39	37	33	30	26			28.275 ₺	38.855 ₺	38.955 ₺
CES-i40-16 05502		7,5	5,5		10,35		48	47	46	42	40	37			28.275 ₺	40.195 ₺	40.300 ₺

Flanşlar hariçtir. Takım fiyatı (Flange Set): 1.325 TL

TİP TYPE	Bağlantı Giriş x Çıkış Inlet x Outlet	MOTOR				m ³ /h Hm (mss)	Debi (Q) - Capacity						FİYAT - PRICE (TL)				
		HP	kW	V	A		d/d	10	20	25	30	35	40	Tek Pompa	Şasesiz	Şaseli	
								Bare Pump	Excl. Base	Incl. Base							
CES-i40-20 04002	1,5" x 1,5"	5,5	4	380/660	7,75	3000	38	31	22				26.115 ₺	39.300 ₺	39.405 ₺		
CES-i40-20 05502		7,5	5,5		10,35		48	43	38	31				26.115 ₺	40.640 ₺	40.745 ₺	
CES-i40-20 07502		10	7,5		13,65		56	52	48	43	34				26.115 ₺	42.985 ₺	43.085 ₺
CES-i40-20 11002		15	11		19,7		62	59	55	52	46	36			28.300 ₺	55.720 ₺	55.820 ₺

Flanşlar hariçtir. Takım fiyatı (Flange Set): 1.325 TL

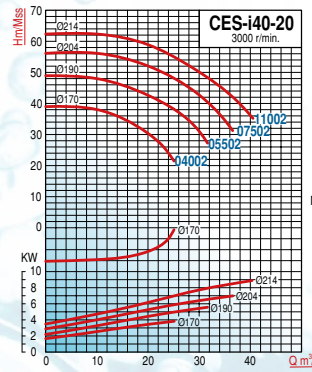
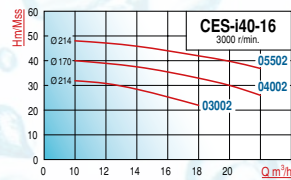
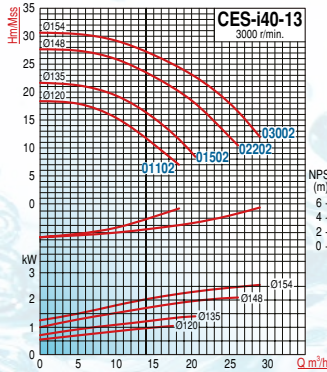

TİP TYPE	Boyutlar - Dimensions (mm)								Çark Çapı mm
	A	DN	h1	h2	H	E	g1	g2	
CES-i40-13 01102	75	40	160	140	300	208	108	100	120
CES-i40-13 01502	75	40	160	140	300	208	108	100	130
CES-i40-13 02202	75	40	160	140	300	208	108	100	147
CES-i40-13 03002	75	40	160	140	300	208	108	100	154
CES-i40-16 03002	75	40	180	160	340	232	122	110	155
CES-i40-16 04002	75	40	180	160	340	232	122	110	170
CES-i40-16 05502	75	40	180	160	340	232	122	110	214
CES-i40-20 04002	75	40	200	180	380	275	140	135	170
CES-i40-20 05502	75	40	200	180	380	275	140	135	190
CES-i40-20 07502	75	40	200	180	380	275	140	135	204
CES-i40-20 11002	75	40	200	180	380	275	140	135	214

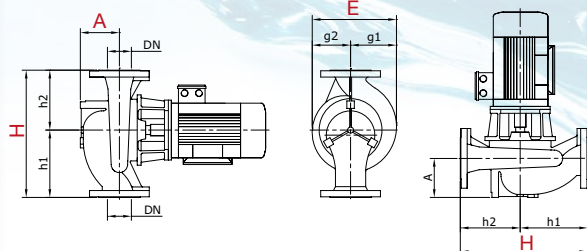

CES-i50 (3000 d/d) HAT TIPI (INLINE) SANTRİFÜJ POMPALAR

INLINE CENTRIFUGAL PUMPS

TİP TYPE	Bağlantı Giriş x Çıkış Inlet x Outlet	MOTOR					m ³ /h	Debi (Q) - Capacity						FİYAT - PRICE (TL)		
		HP	kW	V	A	d/d		10	15	20	25	30	40	Tek Pompa	Şasesiz	Şaseli
														Bare Pump	Excl. Base	Incl. Base
CES-i50-13 01502	2" x 2"	2	1,5	380/660	3,3	3000	Hm (mSS)	18	16	14	10			27.110 ₺	32.360 ₺	32.460 ₺
CES-i50-13 02202		3	2,2		4,3			23	22	20	17	14	27.110 ₺	33.375 ₺	33.480 ₺	
CES-i50-13 03002		4	3		6,3			27	26	24	22	20	27.110 ₺	34.960 ₺	35.060 ₺	
CES-i50-13 04002		5,5	4		8			30	29	28	27	25	19	27.230 ₺	37.800 ₺	37.900 ₺
CES-i50-13 05502		7,5	5,5		10,9			33	32	31	30	28	23	27.230 ₺	39.135 ₺	39.240 ₺
CES-i50-16 03002	2" x 2"	4	3	380/660	6,3	3000	Hm (mSS)	26	24	20	5			26.700 ₺	38.095 ₺	38.195 ₺
CES-i50-16 04002		5,5	4		8			33	32	30	20		26.700 ₺	39.995 ₺	40.100 ₺	
CES-i50-16 05502		7,5	5,5		10,9			40	39	38	34	19	26.700 ₺	41.340 ₺	41.440 ₺	
CES-i50-16 07502		10	7,5		14,1			48	47	45	42	36	16	26.700 ₺	45.005 ₺	45.110 ₺
CES-i50-16 11002		15	11		19,6			52	51	50	47	40	24	28.225 ₺	55.640 ₺	55.740 ₺
CES-i50-20 04002	2" x 2"	5,5	4	380	8	3000	Hm (mSS)	37	20	5				29.635 ₺	39.970 ₺	40.070 ₺
CES-i50-20 05502		7,5	5,5		10,9			44	35	20	15		29.635 ₺	41.310 ₺	41.410 ₺	
CES-i50-20 07502		10	7,5		14,1			49	46	40	34	24	29.635 ₺	43.650 ₺	43.755 ₺	
CES-i50-20 11002		15	11		19,6			58	57	53	50	45	38	32.050 ₺	56.385 ₺	56.490 ₺
CES-i50-20 15002		20	15		28			69	68	66	64	60	54	33.390 ₺	65.615 ₺	65.720 ₺
CES-i50-26 11002	2" x 2"	15	11	380/660	19,6	3000	Hm (mSS)	59	57	53	45			33.100 ₺	57.335 ₺	57.520 ₺
CES-i50-26 15002		20	15		28			70	68	63	57	49	35.640 ₺	67.655 ₺	67.845 ₺	
CES-i50-26 18502		25	18,5		34			78	76	71	65	59	51	35.640 ₺	76.080 ₺	76.270 ₺
CES-i50-26 22002		30	22		40,5			90	88	83	76	69	60	35.640 ₺	86.140 ₺	86.330 ₺
CES-i50-26 30002		40	30		54,6			98	97	93	87	80	71	36.940 ₺	117.490 ₺	117.680 ₺

Flanşlar hariçtir. Takım fiyatı (Flange Set): 1.445 TL

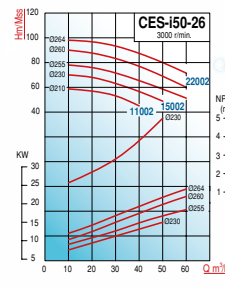
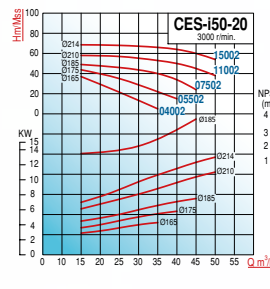
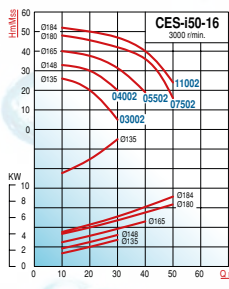
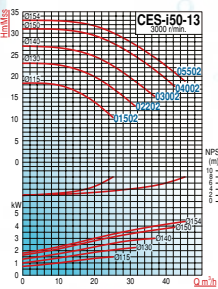

TİP TYPE	Boyutlar - Dimensions (mm)								Çark Çapı mm
	A	DN	h1	h2	H	E	g1	g2	
CES-i50-13 01502									
CES-i50-13 02202									
CES-i50-13 03002									
CES-i50-13 04002									
CES-i50-13 05502									
CES-i50-16 03002	90	50	180	160	340	240	125	115	135
CES-i50-16 04002	90	50	180	160	340	240	125	115	148
CES-i50-16 05502	90	50	180	160	340	240	125	115	165
CES-i50-16 07502	90	50	180	160	340	240	125	115	180
CES-i50-16 11002	90	50	180	160	340	240	125	115	184
CES-i50-20 04002	90	50	225	200	425	282	145	137	165
CES-i50-20 05502	90	50	225	200	425	282	145	137	175
CES-i50-20 07502	90	50	225	200	425	282	145	137	185
CES-i50-20 11002	90	50	225	200	425	282	145	137	210
CES-i50-20 15002	90	50	225	200	425	282	145	137	214
CES-i50-26 11002	90	50	250	225	475	345	175	170	210
CES-i50-26 15002	90	50	250	225	475	345	175	170	230
CES-i50-26 18502	90	50	250	225	475	345	175	170	255
CES-i50-26 22002	90	50	250	225	475	345	175	170	260
CES-i50-26 30002	90	50	250	225	475	345	175	170	264

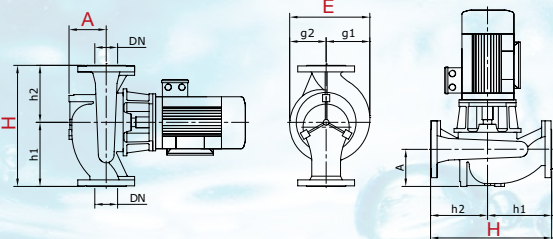

CES-i65 (3000 d/d) HAT TIPI (INLINE) SANTRİFÜJ POMPALAR

INLINE CENTRIFUGAL PUMPS

TİP TYPE	Bağlantı Giriş x Çıkış Inlet x Outlet	MOTOR					m ³ /h	Debi (Q) - Capacity	FİYAT - PRICE (TL)									
		HP	kW	V	A	d/d			Hm (mss)	25	35	40	50	60	65	Tek Pompa	Şasesiz	Şaseli
																Bare Pump	Excl. Base	Incl. Base
CES-i65-13 03002	2.5" x 2.5"	4	3	380/660	6,3	3000	Hm (mss)	19	16	14	8			28.770 ₺	36.455 ₺	36.560 ₺		
CES-i65-13 04002		5,5	4		7,75			24	22	20	15			28.985 ₺	39.385 ₺	39.485 ₺		
CES-i65-13 05502		7,5	5,5		10,3			28	26	25	21	14	11			28.985 ₺	40.725 ₺	40.825 ₺
CES-i65-13 07502		10	7,5		13,6			31	30	28	25	19	16			28.985 ₺	43.065 ₺	43.170 ₺
TİP TYPE	Bağlantı Giriş x Çıkış Inlet x Outlet	MOTOR					m ³ /h	Debi (Q) - Capacity	FİYAT - PRICE (TL)									
		HP	kW	V	A	d/d			Hm (mss)	20	30	40	50	60	70	Tek Pompa	Şasesiz	Şaseli
																Bare Pump	Excl. Base	Incl. Base
CES-i65-16 05502	2.5" x 2.5"	7,5	5,5	380/660	10,3	3000	Hm (mss)	34	32	28	22			30.630 ₺	42.325 ₺	42.430 ₺		
CES-i65-16 07502		10	7,5		13,6			41	40	38	34	26			30.630 ₺	45.995 ₺	46.095 ₺	
CES-i65-16 11002		15	11		19,6			50	49	48	46	41	35			32.040 ₺	56.375 ₺	56.475 ₺
TİP TYPE	Bağlantı Giriş x Çıkış Inlet x Outlet	MOTOR					m ³ /h	Debi (Q) - Capacity	FİYAT - PRICE (TL)									
		HP	kW	V	A	d/d			Hm (mss)	30	40	50	60	70	80	Tek Pompa	Şasesiz	Şaseli
																Bare Pump	Excl. Base	Incl. Base
CES-i65-20 11002	2.5" x 2.5"	15	11	380/660	19,6	3000	Hm (mss)	45	43	41	38	34		32.355 ₺	56.660 ₺	56.850 ₺		
CES-i65-20 15002		20	15		28			54	52	49	46	42	38			33.695 ₺	65.895 ₺	66.085 ₺
CES-i65-20 18502		25	18,5		34			59	58	55	52	48	42			33.695 ₺	74.315 ₺	74.505 ₺
CES-i65-20 22002		30	22		40,5			64	63	61	58	54	48			33.695 ₺	84.375 ₺	84.565 ₺
TİP TYPE	Bağlantı Giriş x Çıkış Inlet x Outlet	MOTOR					m ³ /h	Debi (Q) - Capacity	FİYAT - PRICE (TL)									
		HP	kW	V	A	d/d			Hm (mss)	30	40	55	70	85	105	Tek Pompa	Şasesiz	Şaseli
																Bare Pump	Excl. Base	Incl. Base
CES-i65-26 18502	2.5" x 2.5"	25	18,5	380/660	34	3000	Hm (mss)	67	65	60	54	45		36.185 ₺	76.570 ₺	76.760 ₺		
CES-i65-26 22002		30	22		40,5			75	73	68	62	53			36.185 ₺	86.630 ₺	86.820 ₺	
CES-i65-26 30002		40	30		54,6			93	91	86	79	70	55			37.485 ₺	117.985 ₺	118.175 ₺
CES-i65-26 37002		50	37		68			101	99	94	87	79	64			37.485 ₺	127.470 ₺	127.660 ₺

Flanşlar hariçtir. Takım fiyatı (Flange Set): 1.910 TL

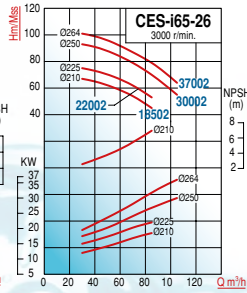
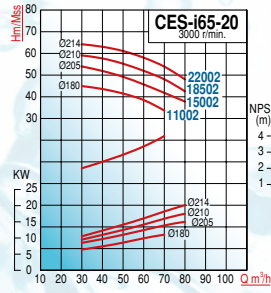
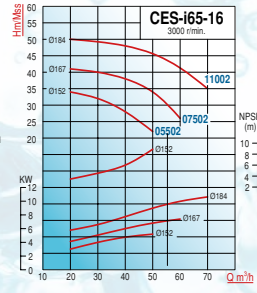
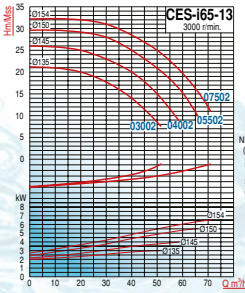

TİP TYPE	Boyutlar - Dimensions (mm)								Çark Çapı mm
	A	DN	h1	h2	H	E	g1	g2	
CES-i65-13 03002	110	40	180	160	340	229	122	107	132
CES-i65-13 04002	110	40	180	160	340	229	122	107	142
CES-i65-13 05502	110	40	180	160	340	229	122	107	148
CES-i65-13 07502	110	40	180	160	340	229	122	107	154
CES-i65-16 05502	110	65	200	180	380	255	135	120	152
CES-i65-16 07502	110	65	200	180	380	255	135	120	167
CES-i65-16 11002	110	65	200	180	380	255	135	120	184
CES-i65-20 11002	110	65	250	225	475	315	165	155	180
CES-i65-20 15002	110	65	250	225	475	315	165	155	205
CES-i65-20 18502	110	65	250	225	475	315	165	155	210
CES-i65-20 22002	110	65	250	225	475	315	165	155	214
CES-i65-26 18502	110	65	250	225	475	343	177	166	180
CES-i65-26 22002	110	65	250	225	475	343	177	166	205
CES-i65-26 30002	110	65	250	225	475	343	177	166	210
CES-i65-26 37002	110	65	250	225	475	343	177	166	214

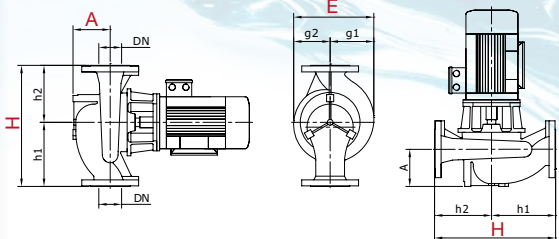

CES-i80 (3000 d/d) HAT TİPİ (INLINE) SANTRİFÜJ POMPALAR

INLINE CENTRIFUGAL PUMPS

TİP TYPE	Bağlantı Giriş x Çıkış Inlet x Outlet	MOTOR						Debi (Q) - Capacity m ³ /h	FİYAT - PRICE (TL)							
		HP	kW	IEC	V	A	d/d		Tek Pompa							
									Bare Pump	Şasesiz Excl. Base	Şaseli Incl. Base					
CES-i80-13 04002	3" x 3"	5,5	4		380/660	7,75	3000	21	19	16	12	29.305 ₺	39.670 ₺	39.775 ₺		
CES-i80-13 05502		7,5	5,5			10,3		24	23	21	19	10	29.305 ₺	41.010 ₺	41.115 ₺	
CES-i80-13 07502		10	7,5			14,1		29	28	27	26	20	15	29.305 ₺	43.350 ₺	43.460 ₺
CES-i80-13 11002		15	11			19,6		32	31	30	29	25	20	29.815 ₺	54.365 ₺	54.470 ₺
CES-i80-16 07502	3" x 3"	10	7,5	132M	380/660	14,1	3000	28	26	23	14	31.250 ₺	50.225 ₺	50.330 ₺		
CES-i80-16 11002		15	11	132M		19,6		35	34	32	25		31.250 ₺	55.660 ₺	55.765 ₺	
CES-i80-16 15002		20	15	160L		28		43	42	40	36	28		31.250 ₺	63.685 ₺	63.790 ₺
CES-i80-16 18502		25	18,5	160L		34		47	46	45	42	36	26	32.920 ₺	73.620 ₺	73.720 ₺
CES-i80-20 15002	3" x 3"	20	15	160L	380/660	28	3000	33	31	27	20	11	2	34.480 ₺	70.775 ₺	70.965 ₺
CES-i80-20 18502		25	18,5	160L		34		44	40	34	28	22	15	34.480 ₺	75.030 ₺	75.220 ₺
CES-i80-20 22002		30	22	160L		40,5		48	44	38	32	26	17	34.480 ₺	85.090 ₺	85.280 ₺
CES-i80-20 30002		40	30	200L		54,6		57	53	48	43	36	25	35.850 ₺	116.505 ₺	116.695 ₺
CES-i80-26 22002	3" x 3"	30	22	160L	380/660	40,5	3000	59	58	43	25	17	2	38.175 ₺	88.430 ₺	88.615 ₺
CES-i80-26 30002		40	30	200L		54,6		65	64	52	39	32	12	39.550 ₺	119.850 ₺	120.040 ₺
CES-i80-26 37002		50	37	200L		68		81	80	67	55	50	40	39.550 ₺	129.335 ₺	129.525 ₺
CES-i80-26 45002		60	45	200L		83,8		91	90	88	72	66	60	39.550 ₺	137.225 ₺	137.415 ₺

Flanşlar hariçtir. Takım fiyatı (Flange Set): 2.215 TL

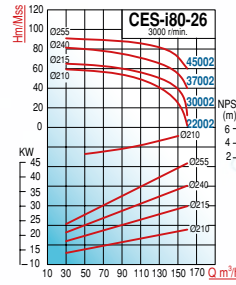
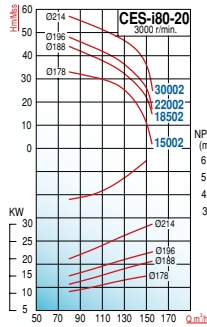
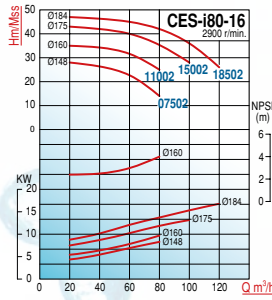
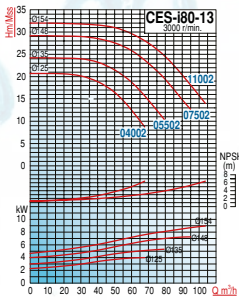

TİP TYPE	Boyutlar - Dimensions (mm)								Çark Çapı mm
	A	DN	h1	h2	H	E	g1	g2	
CES-i80-13 04002									125
CES-i80-13 05502									135
CES-i80-13 07502									148
CES-i80-13 11002									154
CES-i80-16 07502	130	80	225	200	425	281	153	128	148
CES-i80-16 11002	130	80	225	200	425	281	153	128	160
CES-i80-16 15002	130	80	225	200	425	281	153	128	175
CES-i80-16 18502	130	80	225	200	425	281	153	128	184
CES-i80-20 15002	130	80	250	225	475	315	170	145	175
CES-i80-20 18502	130	80	250	225	475	315	170	145	195
CES-i80-20 22002	130	80	250	225	475	315	170	145	205
CES-i80-20 30002	130	80	250	225	475	315	170	145	214
CES-i80-26 22002	140	80	280	280	560	379	197	182	210
CES-i80-26 30002	140	80	280	280	560	379	197	182	215
CES-i80-26 37002	140	80	280	280	560	379	197	182	240
CES-i80-26 45002	140	80	280	280	560	379	197	182	255

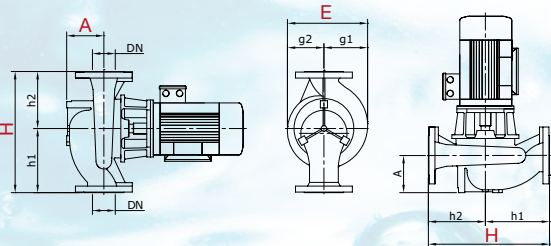

CES-i100 (3000 d/d) HAT TIPI (INLINE) SANTRİFÜJ POMPALAR

INLINE CENTRIFUGAL PUMPS

TİP TYPE	Bağlantı Giriş x Çıkış Inlet x Outlet	MOTOR						m ³ /h	Debi (Q) - Capacity						FİYAT - PRICE (TL)		
		HP	kW	IEC	V	A	d/d		Debi (Q) - Capacity						Tek Pompa Bare Pump	Şasesiz Excl. Base	Şaseli Incl. Base
									70	100	130	160	190	220			
CES-i100-16 11002	4" x 4"	15	11	132	380/660	19,6	3000	Hm (mSS)	26	25	23	19	13		32.525 ₺	56.815 ₺	57.005 ₺
CES-i100-16 15002		20	15	160		26,7			30	29	27,5	25	20	13	34.270 ₺	66.415 ₺	66.605 ₺
CES-i100-16 18502		25	18,5	160		32,6			34	33	31,5	29	25	18	34.270 ₺	74.840 ₺	75.030 ₺
CES-i100-16 22002		30	22	160		31,4			38	37	35,5	33	29	23	34.270 ₺	84.900 ₺	85.090 ₺

Flanşlar hariçtir. Takım fiyatı (Flange Set): 2.565 TL

TİP TYPE	Bağlantı Giriş x Çıkış Inlet x Outlet	MOTOR						m ³ /h	Debi (Q) - Capacity						FİYAT - PRICE (TL)		
		HP	kW	IEC	V	A	d/d		Debi (Q) - Capacity						Tek Pompa Bare Pump	Şasesiz Excl. Base	Şaseli Incl. Base
									90	120	150	180	210	240			
CES-i100-20 18502	4" x 4"	25	18,5	160L	380/660	32,6	3000	Hm (mSS)	41	39	35	29	20		37.545 ₺	77.795 ₺	77.985 ₺
CES-i100-20 22002		30	22	160L		40,5			47	46	44	40	33		37.545 ₺	87.860 ₺	88.045 ₺
CES-i100-20 30002		40	30	200L		54,6			53	52	50	46	40	32	39.010 ₺	119.360 ₺	119.550 ₺
CES-i100-20 37002		50	37	200L.		68			58	57	55	52	47	40	39.010 ₺	128.845 ₺	129.035 ₺
CES-i100-20 45002		60	45	200L		83,8			64	63	62	59	54	46	39.010 ₺	136.740 ₺	136.930 ₺

Flanşlar hariçtir. Takım fiyatı (Flange Set): 2.565 TL

TİP TYPE	Bağlantı Giriş x Çıkış Inlet x Outlet	MOTOR						m ³ /h	Debi (Q) - Capacity						FİYAT - PRICE (TL)		
		HP	kW	IEC	V	A	d/d		Debi (Q) - Capacity						Tek Pompa Bare Pump	Şasesiz Excl. Base	Şaseli Incl. Base
									70	100	130	160	190	220			
CES-i100-26 30002	4" x 4"	40	30	200L	380/660	56,6	3000	Hm (mSS)	59	58	55	50	41	25	43.130 ₺	123.085 ₺	123.275 ₺
CES-i100-26 37002		50	37	200L		68			64	63	61	57	49	35	43.130 ₺	132.570 ₺	132.760 ₺
CES-i100-26 45002		60	45	200L		83,8			70	69	67	63	57	48	43.130 ₺	140.460 ₺	140.650 ₺

Flanşlar hariçtir. Takım fiyatı (Flange Set): 2.565 TL

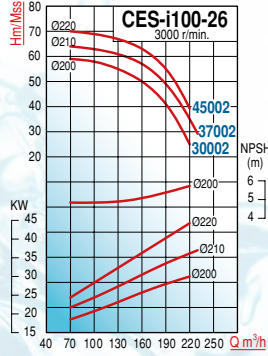
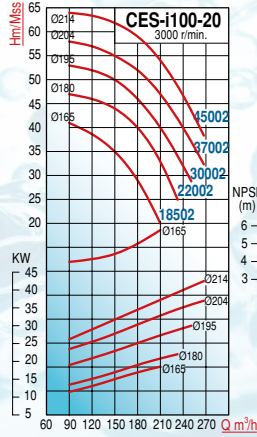
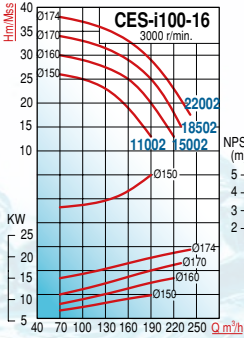

TİP TYPE	Boyutlar - Dimensions (mm)								Çark Çapı mm
	A	DN	h1	h2	H	E	g1	g2	
CES-i100-16 11002	130	100	250	225	475	292	162	130	150
CES-i100-16 15002	130	100	250	225	475	292	162	130	160
CES-i100-16 18502	130	100	250	225	475	292	162	130	170
CES-i100-16 22002	130	100	250	225	475	292	162	130	174
CES-i100-20 18502	170	100	275	250	525	365	170	195	165
CES-i100-20 22002	170	100	275	250	525	365	170	195	180
CES-i100-20 30002	170	100	275	250	525	365	170	195	185
CES-i100-20 37002	170	100	275	250	525	365	170	195	204
CES-i100-20 45002	170	100	275	250	525	365	170	195	214
CES-i100-26 30002	170	100	300	280	580	390	210	180	200
CES-i100-26 37002	170	100	300	280	580	390	210	180	210
CES-i100-26 45002	170	100	300	280	580	390	210	180	220

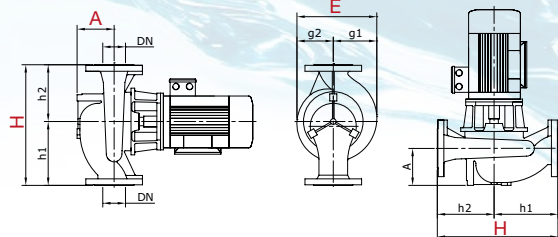

CES-i40 (1500 d/d) HAT TIPI (INLINE) SANTRİFÜJ POMPALAR

INLINE CENTRIFUGAL PUMPS

1500 d/d

TİP TYPE	Bağlantı Giriş x Çıkış Inlet x Outlet	MOTOR					m ³ /h Hm (mss)	Debi (Q) - Capacity						FİYAT - PRICE (TL)		
		HP	kW	V	A	d/d		1	6	8	10	14	16	Tek Pompa Bare Pump	Şasesiz Excl. Base	Şaseli Incl. Base
CES-i40-13 00254	1,5" x 1,5"	0,33	0,25	380	0,95	1500	Hm (mss)	6	5,5	5	4	1		27.240 ₺	28.885 ₺	28.985 ₺
CES-i40-13 00374		0,5	0,37		1,45			7,5	7	6,5	6	3,5	2,5	27.240 ₺	29.165 ₺	29.270 ₺

Flanşlar hariçtir. Takım fiyatı (Flange Set): 1.325 TL

TİP TYPE	Bağlantı Giriş x Çıkış Inlet x Outlet	MOTOR					m ³ /h Hm (mss)	Debi (Q) - Capacity						FİYAT - PRICE (TL)		
		HP	kW	V	A	d/d		1	6	8	10	12	14	Tek Pompa Bare Pump	Şasesiz Excl. Base	Şaseli Incl. Base
CES-i40-16 00554	1,5" x 1,5"	0,75	0,55	380	1,45	1500	Hm (mss)	10,5	10,2	9,4	8,4	7,3	6,2	27.995 ₺	30.910 ₺	31.015 ₺
CES-i40-16 00754		1	0,75		1,95			11,6	11,2	10,7	9,7	8,8	8	27.995 ₺	32.275 ₺	32.380 ₺

Flanşlar hariçtir. Takım fiyatı (Flange Set): 1.325 TL

TİP TYPE	Bağlantı Giriş x Çıkış Inlet x Outlet	MOTOR					m ³ /h Hm (mss)	Debi (Q) - Capacity						FİYAT - PRICE (TL)		
		HP	kW	V	A	d/d		2	5	10	13	15	20	Tek Pompa Bare Pump	Şasesiz Excl. Base	Şaseli Incl. Base
CES-i40-20 00554	1,5" x 1,5"	0,75	0,55	380	1,45	1500	Hm (mss)	10	9,5	7,5	5	3		25.990 ₺	31.405 ₺	31.510 ₺
CES-i40-20 00754		1	0,75		1,95			12,5	12	10,5	9	7,5		25.990 ₺	32.770 ₺	32.875 ₺
CES-i40-20 01104		1,5	1,1		2,64			15	14,5	13,5	12,5	11	7,5		26.175 ₺	34.430 ₺

Flanşlar hariçtir. Takım fiyatı (Flange Set): 1.325 TL

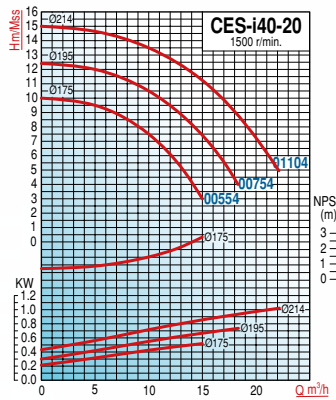
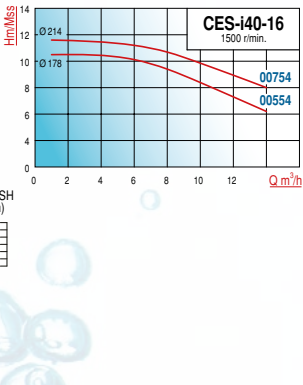
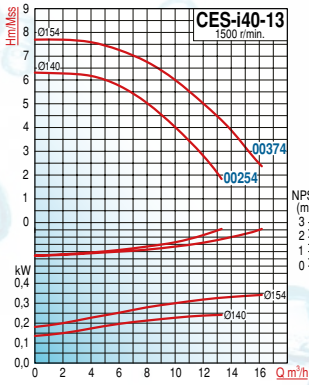

TİP TYPE	Boyutlar - Dimensions (mm)							Çark Çapı mm	
	A	DN	h1	h2	H	E	g1		g2
CES-i40-16 00554	75	40	180	160	340	232	122	110	178
CES-i40-16 00754	75	40	180	160	340	232	122	110	214
CES-i40-20 00554	75	40	200	180	380	275	140	135	175
CES-i40-20 00754	75	40	200	180	380	275	140	135	195
CES-i40-20 01104	75	40	200	180	380	275	140	135	214

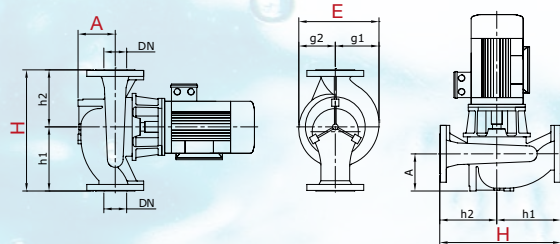

CES-i50 (1500 d/d) HAT TİPİ (INLINE) SANTRİFÜJ POMPALAR

INLINE CENTRIFUGAL PUMPS

1500 d/d

TİP TYPE	Bağlantı Giriş x Çıkış Inlet x Outlet	MOTOR					Debi (Q) - Capacity m ³ /h	Debi (Q) - Capacity						FİYAT - PRICE (TL)				
		HP	kW	V	A	d/d		0	7	12	15	18	20	Tek Pompa	Şasesiz	Şaseli		
														Bare Pump	Excl. Base	Incl. Base		
CES-i50-13 00254	2' x 2"	0,33	0,25	380	0,95	1500	Hm (mSS)	5,3	5	4	2,5			26.940 ₺	28.615 ₺	28.720 ₺		
CES-i50-13 00374		1	0,37		1,45			6,6	6,5	5,7	5	3,7			26.940 ₺	28.895 ₺	29.000 ₺	
CES-i50-13 00554		0,75	0,55		1,95			8,1	8	7,5	7	6	5,5			27.010 ₺	29.835 ₺	29.935 ₺
CES-i50-16 00754	2' x 2"	1	0,75	380	1,9	1500	Hm (mSS)	11	10,5	10	9,5	9	6,5	26.620 ₺	33.590 ₺	33.695 ₺		
CES-i50-16 01104		1,5	1,1		2,6			13	12,5	12	11,5	11	9,5			26.870 ₺	35.235 ₺	35.340 ₺
CES-i50-20 00754	2" x 2"	1	0,75	380	1,9	1500	Hm (mSS)	8	12	14	16	18	20	29.430 ₺	33.380 ₺	33.485 ₺		
CES-i50-20 01104		1,5	1,1		2,6			10	9,5	9	8	7			29.635 ₺	35.040 ₺	35.140 ₺	
CES-i50-20 01504		2,0	1,5		3,5			13,5	13	12,5	11,5	10,5	9			29.635 ₺	36.465 ₺	36.570 ₺
CES-i50-20 02204		3	2,2		4,8			15	14,4	14	13	12	10,5			29.635 ₺	38.590 ₺	38.690 ₺
CES-i50-26 01504	2' x 2"	2	1,5	380	3,5	1500	Hm (mSS)	9	12	15	18	23	25	31.915 ₺	38.525 ₺	38.715 ₺		
CES-i50-26 02204		3	2,2		5,1			16	15	14,5	13,5	11			31.915 ₺	40.765 ₺	40.955 ₺	
CES-i50-26 03004		4	3		6,6			20	19,5	19	18	15,5			31.915 ₺	42.295 ₺	42.485 ₺	

Flanşlar hariçtir. Takım fiyatı (Flange Set): 1.445 TL

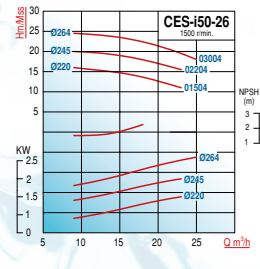
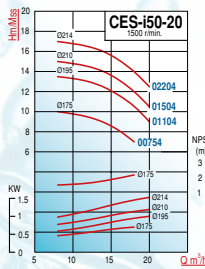
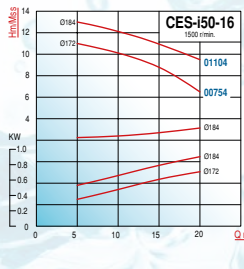
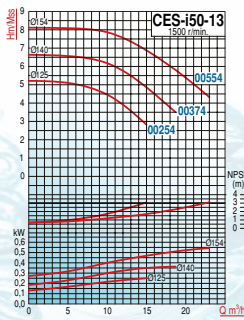

TİP TYPE	Boyutlar - Dimensions (mm)								Çark Çapı mm
	A	DN	h1	h2	H	E	g1	g2	
CES-i50-13 00254									137
CES-i50-13 00374									140
CES-i50-13 00554									154
CES-i50-16 00754	90	50	180	160	340	240	125	115	172
CES-i50-16 01104	90	50	180	160	340	240	125	115	184
CES-i50-20 00754	90	50	225	200	425	282	145	137	175
CES-i50-20 01104	90	50	225	200	425	282	145	137	195
CES-i50-20 01504	90	50	225	200	425	282	145	137	210
CES-i50-20 02204	90	50	225	200	425	282	145	137	214
CES-i50-26 01504	90	50	250	225	475	345	175	170	220
CES-i50-26 02204	90	50	250	225	475	345	175	170	245
CES-i50-26 03004	90	50	250	225	475	345	175	170	264

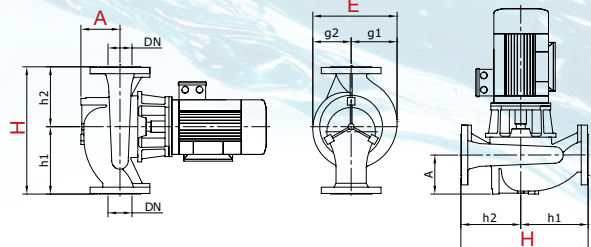

CES-i65 (1500 d/d) HAT TIPI (INLINE) SANTRİFÜJ POMPALAR

1500 d/d

INLINE CENTRIFUGAL PUMPS

TİP TYPE	Bağlantı Giriş x Çıkış Inlet x Outlet	MOTOR					m ³ /h Hm (mSS)	Debi (Q) - Capacity						FİYAT - PRICE (TL)			
		HP	kW	V	A	d/d								Tek Pompa Bare Pump	Şasesiz Excl. Base	Şaseli Incl. Base	
								0	10	12	16	20	25				
CES-i65-13 00374	2.5" x 2.5"	0,5	0,37	380	0,95	1500	Hm (mSS)	4,5	4,4	4,2	3,6	3		28.695 ₺	30.480 ₺	30.585 ₺	
CES-i65-13 00554		0,75	0,55		1,45			6,5	6,4	6,3	6	5,5		28.770 ₺	31.420 ₺	31.520 ₺	
CES-i65-13 00754		1	0,75		1,95			7,5	7,4	7,3	7,2	6,6	5,5		28.770 ₺	32.785 ₺	32.885 ₺
TİP TYPE	Bağlantı Giriş x Çıkış Inlet x Outlet	MOTOR					m ³ /h Hm (mSS)	Debi (Q) - Capacity						FİYAT - PRICE (TL)			
HP		kW	V	A	d/d							Tek Pompa Bare Pump	Şasesiz Excl. Base	Şaseli Incl. Base			
						10		15	20	25	30				35		
CES-i65-16 00754	2.5" x 2.5"	1	0,75	380	1,95	1500	Hm (mSS)	8,5	8	7	5,5			30.135 ₺	34.210 ₺	34.315 ₺	
CES-i65-16 01104		1,5	1,1		2,6			10,5	10	9,5	8,5	7		30.290 ₺	35.740 ₺	35.845 ₺	
CES-i65-16 01504		2	1,5		3,4			12,5	12	11,5	11	10	8,5		30.290 ₺	37.165 ₺	37.270 ₺
TİP TYPE	Bağlantı Giriş x Çıkış Inlet x Outlet	MOTOR					m ³ /h Hm (mSS)	Debi (Q) - Capacity						FİYAT - PRICE (TL)			
HP		kW	V	A	d/d							Tek Pompa Bare Pump	Şasesiz Excl. Base	Şaseli Incl. Base			
						15		20	25	30	35				40		
CES-i65-20 01104	2.5" x 2.5"	1,5	1,1	380	2,6	1500	Hm (mSS)	10,5	10	9	8			29.940 ₺	35.315 ₺	35.505 ₺	
CES-i65-20 01504		2	1,5		3,5			12,5	12,2	11,5	10,5	9,5		29.940 ₺	36.740 ₺	36.930 ₺	
CES-i65-20 02204		3	2,2		5,1			15	14,5	14	13,5	12,5	11		29.940 ₺	38.865 ₺	39.055 ₺
CES-i65-20 03004		4	3		2,6			16,5	16	15,5	15	14	12,5		29.940 ₺	40.395 ₺	40.585 ₺
TİP TYPE	Bağlantı Giriş x Çıkış Inlet x Outlet	MOTOR					m ³ /h Hm (mSS)	Debi (Q) - Capacity						FİYAT - PRICE (TL)			
HP		kW	V	A	d/d							Tek Pompa Bare Pump	Şasesiz Excl. Base	Şaseli Incl. Base			
						15		25	30	35	40				50		
CES-i65-26 02204	2.5" x 2.5"	3	2,2	380	4,8	1500	Hm (mSS)	15,5	14,5	13	11			32.565 ₺	41.240 ₺	41.425 ₺	
CES-i65-26 03004		4	3		6,6			19,5	19	18	16,5	14,5		32.565 ₺	42.770 ₺	42.960 ₺	
CES-i65-26 04004		5,5	4		8,3			22,5	22	21,5	21	20	17		32.565 ₺	45.860 ₺	46.050 ₺
CES-i65-26 05504		7,5	5,5		14,1			24,5	24	23,5	23	22	19		32.565 ₺	48.960 ₺	49.150 ₺

Flanşlar hariçtir. Takım fiyatı (Flange Set): 1.910 TL

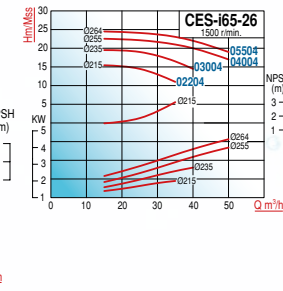
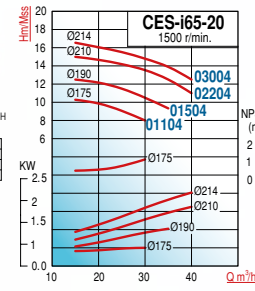
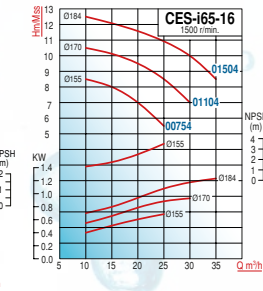
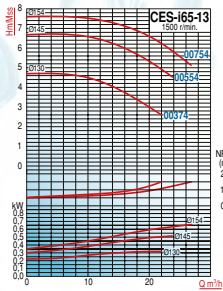

TİP TYPE	Boyutlar - Dimensions (mm)								Çark Çapı mm
	A	DN	h1	h2	H	E	g1	g2	
CES-i65-13 00374	110	40	180	160	340	229	122	107	130
CES-i65-13 00554	110	40	180	160	340	229	122	107	145
CES-i65-13 00754	110	40	180	160	340	229	122	107	154
CES-i65-16 00754	110	65	200	180	380	255	135	120	155
CES-i65-16 01104	110	65	200	180	380	255	135	120	170
CES-i65-16 01504	110	65	200	180	380	255	135	120	184
CES-i65-20 01104	110	65	250	225	475	315	165	155	175
CES-i65-20 01504	110	65	250	225	475	315	165	155	190
CES-i65-20 02204	110	65	250	225	475	315	165	155	210
CES-i65-20 03004	110	65	250	225	475	315	165	155	214
CES-i65-26 02204	110	65	250	225	475	343	177	166	175
CES-i65-26 03004	110	65	250	225	475	343	177	166	190
CES-i65-26 04004	110	65	250	225	475	343	177	166	210
CES-i65-26 05504	110	65	250	225	475	343	177	166	214

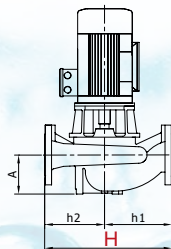
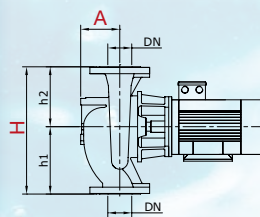

CES-i80 (1500 d/d)

HAT TIPI (INLINE) SANTRİFÜJ POMPALAR

1500 d/d

INLINE CENTRIFUGAL PUMPS

TİP TYPE	Bağlantı Giriş x Çıkış Inlet x Outlet	MOTOR						m ³ /h	Debi (Q) - Capacity						FİYAT - PRICE (TL)				
		HP	kW	IEC	V	A	d/d		Hm (mSS)	10	15	20	25	35	45	Tek Pompa Bare Pump	Şasesiz Excl. Base	Şaseli Incl. Base	
																			FİYAT - PRICE (TL)
CES-i80-13 00374	3" x 3"	0,50	0,37	71M	380/660	0,8	1500	Hm (mSS)	4	3,8	3,2	2,2			29.015 ₺	30.770 ₺	30.875 ₺		
CES-i80-13 00554		1	0,55	80M		1,45			5,2	5	4,8	4,2	2,2			29.015 ₺	31.640 ₺	31.745 ₺	
CES-i80-13 00754		1	0,75	80M		1,95			6,4	6,3	6,2	5,8	4,4			29.085 ₺	33.070 ₺	33.175 ₺	
CES-i80-13 01104		2	1,1	80M		2,6			7,4	7,3	7,2	7	6	4			29.085 ₺	34.350 ₺	34.455 ₺
CES-i80-16 00554	3" x 3"	0,75	0,55	80M	380/660	1,45	1500	Hm (mSS)	5	4	3				29.475 ₺	32.250 ₺	32.355 ₺		
CES-i80-16 00754		1	0,75	80M		1,95			7	6	5	3				29.475 ₺	33.615 ₺	33.715 ₺	
CES-i80-16 01104		1,5	1,1	80M		2,6			9	8	7	5				29.475 ₺	35.005 ₺	35.110 ₺	
CES-i80-16 01504		2	1,5	90L		3,5			10	9	8	7	6			29.630 ₺	36.570 ₺	36.675 ₺	
CES-i80-16 02204		3	2,2	90L		5,1			12	11	10	9	8	6			29.630 ₺	40.105 ₺	40.205 ₺
CES-i80-20 01504	3" x 3"	2	1,5	90L	380/660	1,45	1500	Hm (mSS)	9	8,5	7	5			30.730 ₺	37.455 ₺	37.645 ₺		
CES-i80-20 02204		3	2,2	90L		1,95			11	10,5	9,5	7,5				30.730 ₺	39.580 ₺	39.770 ₺	
CES-i80-20 03004		4	3	100L		2,6			14	13,5	12,5	11	8,5			30.730 ₺	41.110 ₺	41.300 ₺	
CES-i80-20 04004		5,5	4	100L		3,5			16	15,5	14,5	13	11	8			30.730 ₺	44.200 ₺	44.390 ₺
CES-i80-26 02204	3" x 3"	3	2,2	90L	380/660	5,1	1500	Hm (mSS)	13,5	12	9	2			34.920 ₺	43.370 ₺	43.560 ₺		
CES-i80-26 03004		4	3	100L		6,6			16	15,5	14,5	12,5				34.920 ₺	44.900 ₺	45.090 ₺	
CES-i80-26 04004		5,5	4	100L		8,3			19,5	19	17,5	16	14			34.920 ₺	47.995 ₺	48.185 ₺	
CES-i80-26 05504		7,5	5,5	112M		14,1			22,5	22	21	20	19	17,5			34.920 ₺	51.090 ₺	51.280 ₺
CES-i80-26 07504		10	7,5	132M		15,7			25	24,5	24	23	22	20			35.920 ₺	56.440 ₺	56.625 ₺

Flanşlar hariçtir. Takım fiyatı (Flange Set): 2.215 TL

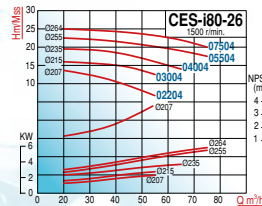
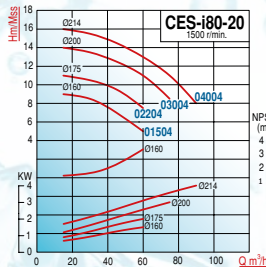
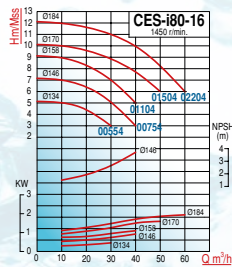
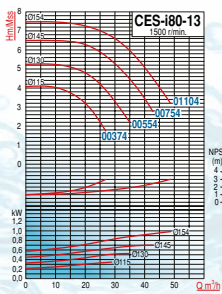

TİP TYPE	Boyutlar - Dimensions (mm)							Çark Çapı mm
	A	DN	h1	h2	H	E	g1	
CES-i80-13 00374								115
CES-i80-13 00554								130
CES-i80-13 00754								145
CES-i80-13 01104								154
CES-i80-16 00554	130	80	225	200	425	281	153	128
CES-i80-16 00754	130	80	225	200	425	281	153	128
CES-i80-16 01104	130	80	225	200	425	281	153	128
CES-i80-16 01504	130	80	225	200	425	281	153	128
CES-i80-16 02204	130	80	225	200	425	281	153	128
CES-i80-20 01504	130	80	250	225	475	315	170	145
CES-i80-20 02204	130	80	250	225	475	315	170	145
CES-i80-20 03004	130	80	250	225	475	315	170	145
CES-i80-20 04004	130	80	250	225	475	315	170	145
CES-i80-26 03004	140	80	280	280	560	379	197	182
CES-i80-26 04004	140	80	280	280	560	379	197	182
CES-i80-26 05504	140	80	280	280	560	379	197	182
CES-i80-26 07504	140	80	280	280	560	379	197	182

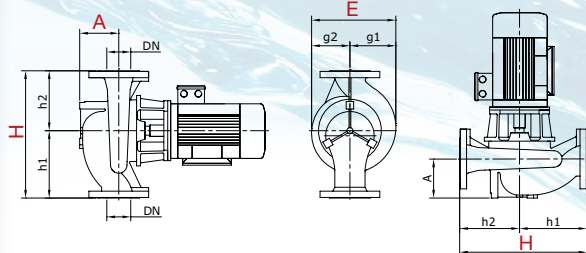

CES-i100 (1500 d/d) HAT TIPI (INLINE) SANTRİFÜJ POMPALAR

1500 d/d

INLINE CENTRIFUGAL PUMPS

TİP TYPE	Bağlantı Giriş x Çıkış Inlet x Outlet	MOTOR						m ³ /h	Debi (Q) - Capacity						FİYAT - PRICE (TL)		
		HP	kW	IEC	V	A	d/d		30	40	50	60	70	80	Tek Pompa Bare Pump	Şasesiz Excl. Base	Şaseli Incl. Base
CES-i100-16 01504	4" x 4"	2	1,5	90	380/660	1,45	1500	Hm (mSS)	8,5	7,5	6,5	5,5	4		30.980 ₺	37.790 ₺	37.980 ₺
CES-i100-16 02204		3	2,2	90		1,95			10,5	10	9,5	8,5	7,5	6	31.105 ₺	40.035 ₺	40.225 ₺
CES-i100-16 03004		4,0	3	90	2,6	12			11,5	11	10	9	7,5	31.105 ₺	41.795 ₺	41.985 ₺	

Flanşlar hariçtir. Takım fiyatı (Flange Set): 2.565 TL

TİP TYPE	Bağlantı Giriş x Çıkış Inlet x Outlet	MOTOR						m ³ /h	Debi (Q) - Capacity						FİYAT - PRICE (TL)		
		HP	kW	IEC	V	A	d/d		40	55	70	85	100	115	Tek Pompa Bare Pump	Şasesiz Excl. Base	Şaseli Incl. Base
CES-i100-20 03004	4" x 4"	4	3	100L	380/660	6,6	1500	Hm (mSS)	11	10	9,5	8			33.685 ₺	43.785 ₺	43.975 ₺
CES-i100-20 04004		5,5	4	100L		8,3			13	12,5	12	11	6,5		33.685 ₺	46.875 ₺	47.065 ₺
CES-i100-20 05504		7,5	5,5	112M	11,4	15			14,5	14	13,5	10,5	8	33.685 ₺	49.975 ₺	50.165 ₺	

Flanşlar hariçtir. Takım fiyatı (Flange Set): 2.565 TL

TİP TYPE	Bağlantı Giriş x Çıkış Inlet x Outlet	MOTOR						m ³ /h	Debi (Q) - Capacity						FİYAT - PRICE (TL)		
		HP	kW	IEC	V	A	d/d		40	60	80	100	115	130	Tek Pompa Bare Pump	Şasesiz Excl. Base	Şaseli Incl. Base
CES-i100-26 04004	4" x 4"	5,5	4	100L	380/660	8,3	1500	Hm (mSS)	15	14,5	13,5				37.855 ₺	50.645 ₺	50.835 ₺
CES-i100-26 05504		7,5	5,5	112M		14,1			17,5	17	16	15	13		37.855 ₺	53.745 ₺	53.930 ₺
CES-i100-26 07504		10	7,5	132M		15,7			21,5	21	20	18,5	16,5	14	39.455 ₺	59.635 ₺	59.825 ₺
CES-i100-26 11004		15	11	132M		21,6			24,5	24	23,5	22	20,5	18,5	39.455 ₺	71.025 ₺	71.215 ₺

Flanşlar hariçtir. Takım fiyatı (Flange Set): 2.565 TL

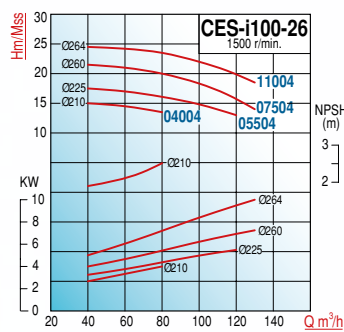
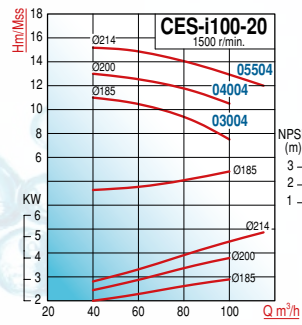
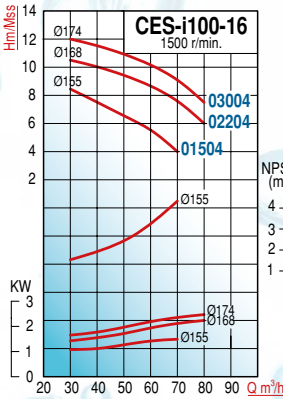

TİP TYPE	Boyutlar - Dimensions (mm)								Çark Çapı mm
	A	DN	h1	h2	H	E	g1	g2	
CES-i100-16 01504	130	100	250	225	475	292	162	130	155
CES-i100-16 02204	130	100	250	225	475	292	162	130	168
CES-i100-16 03004	130	100	250	225	475	292	162	130	174
CES-i100-20 03004	170	100	275	250	525	365	170	195	185
CES-i100-20 04004	170	100	275	250	525	365	170	195	200
CES-i100-20 05504	170	100	275	250	525	365	170	195	214
CES-i100-26 04004	170	100	300	280	580	390	210	180	210
CES-i100-26 05504	170	100	300	280	580	390	210	180	225
CES-i100-26 07504	170	100	300	280	580	390	210	180	245
CES-i100-26 11004	170	100	300	280	580	390	210	180	264

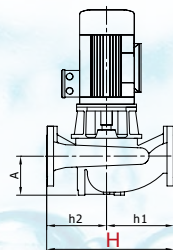
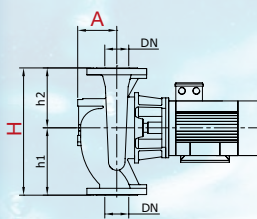

ES (3000 d/d & 1500 d/d) (TS EN 733)

SALYANGOZ KAPLINLI POMPALAR (Yumuşak veya Mekanik Salmastralı)

VOLUTE CASING LONG-COUPLED PUMPS (Soft Packing / Mechanical Seal)



TEKNİK ÖZELLİKLER

- Kapasite: 10 - 320 m³/h
- Basma Yüksekliği: 9 - 156 m
- Devir Hızı: 1500 - 3000 d/d
- Sıvı Sıcaklığı: -10 °C ~ +110 °C
- Flanşlar TS EN 1092 - 2 / PN 16' ya uygundur.
- Giriş Flanşları: DN65 - DN125
- Çıkış Flanşları: DN 40 - DN100 (Flanşlar opsiyoneldir.)
- Yataklama: Mil yatağındaki 2 adet ağır hizmet tipi rulmanla sağlanır/ Gres yağlamalı (opsiyonel)
- Eksenel yük çark dengeleme delikleri ile dengelenir
- İzolasyon sınıfı: F
- Koruma sınıfı: IP55
- Emme derinliği: 6.5mt.

MALZEME ÖZELLİKLERİ

- Çark: Pik GG-25
- Emici ve Verici Gövde: Pik GG-25
- Mil: X20Cr13 (AISI420), Opsiyonel: AISI316 çelik
- Sızdırmazlık: Yumuşak veya Mekanik salmastra (Ca-Sic-Viton)
- Kaplin: Elastik
- Aşınma Halkası: GG-25 Pik Döküm

KULLANIM ALANLARI

- Temiz su temini
- Tarımsal sulama(Damlama ve Sprink sistemleri)
- Buhar kazanları besli,
- Kondens sistemleri
- Endüstri ve inşaatlar
- Soğutma sistemleri
- Sirkülasyon
- Yangın söndürme

OPSİYONEL

- Açık Çark
- Bronz Çark
- AISI 316 / AISI 304 Çelik Mil

TECHNICAL DATA

- Capacity: 10 - 320 m³/h
- Total Head: 9 - 156
- Rotation Speed: 1500 - 3000 rpm
- Liquid Temp.: -10°C ~ +110°C
- Suction and discharge flanges conform to EN 1092-2 / PN 16
- Inlet Flanges: DN65 - DN125
- Outlet Flanges: DN40 - DN100 (Flanges are optional)
- Bearing: Pump Shaft is supported by 2 Heavy duty ball bearings on bearing housing / Grease lubricated (Optional)
- Axial load is reduced by balance holes
- Insulation Class: F
- Protection Class: IP55
- Suction lift: Max 6.5 m.

MATERIAL SPECIFICATIONS

- Impellers: Cast iron GG-25
- Inlet & Outlet Bodies: Cast iron GG-25
- Pump Shaft: X20Cr13 (AISI420) steel, Optional: AISI316 stainless steel.
- Non-Leakage: Soft packing / Mechanical seal (Ca-Sic-Viton)
- Coupling: Flexible
- Wear Ring: Cast iron GG-25

APPLICATIONS

- Clean water supply
- Irrigation (Drip and Sprinkler systems)
- Boiler feeding
- Condens systems
- Industrial plants, Constructions
- Chiller systems
- Circulation
- Fire fighting

OPTIONAL

- Open Impeller
- Bronze Impeller
- AISI 316 / AISI 304 S/S Shaft

ES40 (3000 d/d) (Yumuşak veya Mekanik Salmastralı) SALYANGOZ KAPLINLİ POMPALAR

VOLUTE CASING LONG-COUPLED PUMPS (Soft Packing / Mechanical Seal)

TİP TYPE	Bağlantı Giriş x Çıkış Inlet x Outlet	MOTOR			m ³ /h Hm (mSS)	Debi (Q) - Capacity						FİYAT - PRICE (TL)		
		HP	kW	V		10	15	20	30	40	50	Tek Pompa Bare Pump	Şasi & Kaplin Base & Coupling	Pompa & Mot. Akuple Pump & Mot. Coupled
	ES40-16 04002	2.5"x1.5"	5,5	4		380	32	31	29	24			27.460 ₺	1.595 ₺
ES40-16 05502	7,5		5,5	380 / 660	40	39	38	34	23		27.460 ₺	1.595 ₺	42.775 ₺	
ES40-16 07502	10		7,5	380 / 660	48	47	46	44	37	22	27.460 ₺	1.885 ₺	45.375 ₺	
ES40-16 11002	15		11	380 / 660	53	52	51	49	44	34	27.460 ₺	1.940 ₺	55.575 ₺	

Flanşlar hariçtir. Takım fiyatı (Flange Set): 1.515 TL / Mekanik salmastra fiyat farkı: 65 EURO

TİP TYPE	Bağlantı Giriş x Çıkış Inlet x Outlet	MOTOR			m ³ /h Hm (mSS)	Debi (Q) - Capacity						FİYAT - PRICE (TL)		
		HP	kW	V		15	25	30	35	40	50	Tek Pompa Bare Pump	Şasi & Kaplin Base & Coupling	Pompa & Mot. Akuple Pump & Mot. Coupled
	ES40-20 04002	2.5" x 1.5"	5,5	4		380	37	20	5				28.515 ₺	1.865 ₺
ES40-20 05502	7,5		5,5	380 / 660	44	35	20	15			28.515 ₺	1.865 ₺	44.100 ₺	
ES40-20 07502	10		7,5	380 / 660	45	42	39	35	30		28.515 ₺	1.865 ₺	46.410 ₺	
ES40-20 11002	15		11	380 / 660	59	58	56	53	48	37	28.515 ₺	2.155 ₺	56.845 ₺	
ES40-20 15002	20		15	380 / 660	66	65	63	60	56	45	28.515 ₺	2.770 ₺	65.315 ₺	

Flanşlar hariçtir. Takım fiyatı (Flange Set): 1.515 TL / Mekanik salmastra fiyat farkı: 65 EURO

TİP TYPE	Bağlantı Giriş x Çıkış Inlet x Outlet	MOTOR			m ³ /h Hm (mSS)	Debi (Q) - Capacity						FİYAT - PRICE (TL)		
		HP	kW	V		10	20	30	40	50	60	Tek Pompa Bare Pump	Şasi & Kaplin Base & Coupling	Pompa & Mot. Akuple Pump & Mot. Coupled
	ES40-26 15002	2.5" x 1.5"	20	15		380 / 660	70	68	63	57	49		31.860 ₺	2.770 ₺
ES40-26 18502	25		18,5	380 / 660	78	76	72	66	59	51	31.860 ₺	2.770 ₺	75.830 ₺	
ES40-26 22002	30		22	380 / 660	90	88	83	77	69	60	31.945 ₺	2.770 ₺	85.970 ₺	
ES40-26 30002	40		30	380 / 660	98	97	93	87	80	71	31.945 ₺	3.365 ₺	110.930 ₺	

Flanşlar hariçtir. Takım fiyatı (Flange Set): 1.515 TL / Mekanik salmastra fiyat farkı: 65 EURO

TİP TYPE	Bağlantı Giriş x Çıkış Inlet x Outlet	MOTOR			m ³ /h Hm (mSS)	Debi (Q) - Capacity						FİYAT - PRICE (TL)		
		HP	kW	V		15	20	30	35	40	50	Tek Pompa Bare Pump	Şasi & Kaplin Base & Coupling	Pompa & Mot. Akuple Pump & Mot. Coupled
	ES40-32 22002	2.5" x 1.5"	30	22		380 / 660	93	92	89	86	82		38.160 ₺	2.785 ₺
ES40-32 30002	40		30	380 / 660	105	103	99	97	94		38.160 ₺	3.365 ₺	117.145 ₺	
ES40-32 37002	50		37	380 / 660	130	129	124	121	118	110	38.160 ₺	3.365 ₺	126.630 ₺	
ES40-32 45002	60		45	380 / 660	143	142	137	134	131	123	38.240 ₺	4.570 ₺	135.805 ₺	
ES40-32 55002	75		55	380 / 660	156	155	151	148	145	140	38.240 ₺	6.230 ₺	FİYAT SORUNUZ	

Flanşlar hariçtir. Takım fiyatı (Flange Set): 1.515 TL / Mekanik salmastra fiyat farkı: 74 EURO



ES40 (3000 d/d) (Yumuşak veya Mekanik Salmastralı) SALYANGOZ KAPLINLİ POMPALAR

VOLUTE CASING LONG-COUPLED PUMPS (Soft Packing / Mechanical Seal)

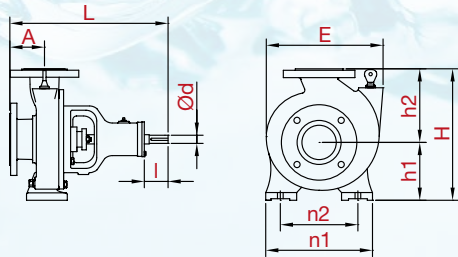
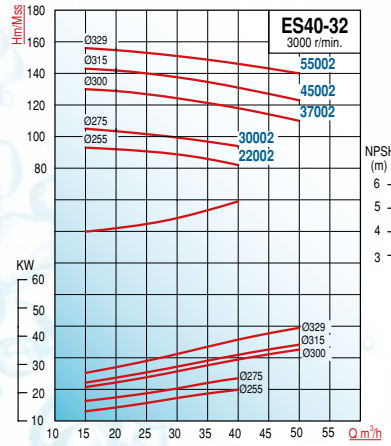
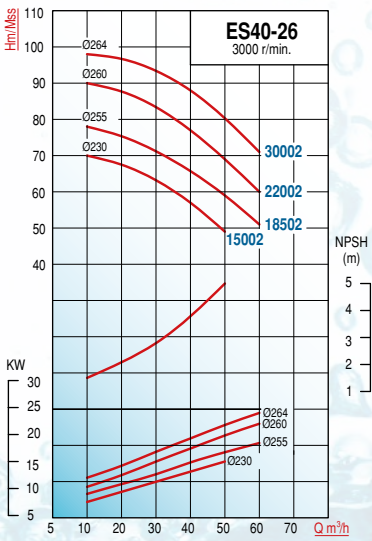
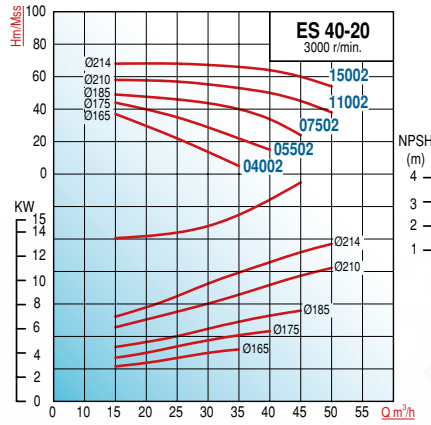
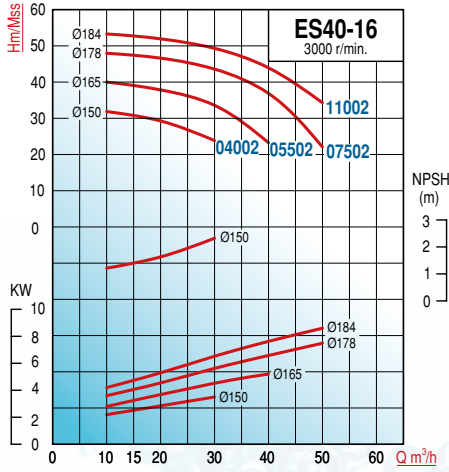

TİP TYPE	Boyutlar - Dimensions (mm)										Ağırlık - Weight
	A	L	h1	h2	H	E	n1	n2	l	d	Kg
ES40-16	80	445	132	160	292	246	240	190	55	24	35
ES40-20	100	460	160	180	340	290	265	212	55	24	42
ES40-26	100	460	180	225	405	340	320	250	55	24	59
ES40-32	125	595	200	250	450	400	345	280	80	32	87

ES50 (3000 d/d) (Yumuşak veya Mekanik Salmastralı) SALYANGOZ KAPLINLI POMPALAR

VOLUTE CASING LONG-COUPLED PUMPS (Soft Packing / Mechanical Seal)

TİP TYPE	Bağlantı Giriş x Çıkış Inlet x Outlet	MOTOR			m ³ /h Hm (mSS)	Debi (Q) - Capacity						FİYAT - PRICE (TL)		
		HP	kW	V		20	30	40	50	60	70	Tek Pompa Bare Pump	Şasi & Kaplin Base & Coupling	Pompa & Mot. Akuple Pump & Mot. Coupled
ES50-16 05502	2.5" x 2"	7,5	5,5	380/660	Hm (mSS)	29	28	26	22			27.870 ₺	1.595 ₺	43.190 ₺
ES50-16 07502		10	7,5			37	36	34	31	26		27.870 ₺	1.885 ₺	45.785 ₺
ES50-16 11002		15	11			47	46	45	42	39	35	27.870 ₺	1.940 ₺	55.990 ₺

Flanşlar hariçtir. Takım fiyatı (Flange Set): 1.620 TL / Mekanik salmastra fiyat farkı: 65 EURO

TİP TYPE	Bağlantı Giriş x Çıkış Inlet x Outlet	MOTOR			m ³ /h Hm (mSS)	Debi (Q) - Capacity						FİYAT - PRICE (TL)		
		HP	kW	V		30	40	50	60	70	80	Tek Pompa Bare Pump	Şasi & Kaplin Base & Coupling	Pompa & Mot. Akuple Pump & Mot. Coupled
ES50-20 11002	2.5" x 2"	15	11	380/660	Hm (mSS)	45	43	41	38	34		29.125 ₺	1.940 ₺	57.240 ₺
ES50-20 15002		20	15			54	52	49	46	42	38	29.125 ₺	2.665 ₺	65.815 ₺
ES50-20 18502		25	18,5			59	58	55	52	48	42	29.125 ₺	2.665 ₺	72.985 ₺
ES50-20 22002		30	22			64	63	61	58	54	48	29.125 ₺	2.665 ₺	83.045 ₺

Flanşlar hariçtir. Takım fiyatı (Flange Set): 1.620 TL / Mekanik salmastra fiyat farkı: 65 EURO

TİP TYPE	Bağlantı Giriş x Çıkış Inlet x Outlet	MOTOR			m ³ /h Hm (mSS)	Debi (Q) - Capacity						FİYAT - PRICE (TL)		
		HP	kW	V		30	40	55	70	85	105	Tek Pompa Bare Pump	Şasi & Kaplin Base & Coupling	Pompa & Mot. Akuple Pump & Mot. Coupled
ES50-26 18502	2.5" x 2"	25	18,5	380/660	Hm (mSS)	67	65	60	54	45		32.210 ₺	2.665 ₺	76.070 ₺
ES50-26 22002		30	22			75	73	68	62	53		32.210 ₺	2.665 ₺	86.130 ₺
ES50-26 30002		40	30			93	91	86	79	70	55	32.290 ₺	3.365 ₺	111.280 ₺
ES50-26 37002		50	37			101	99	94	88	79	64	32.290 ₺	3.365 ₺	120.765 ₺

Flanşlar hariçtir. Takım fiyatı (Flange Set): 1.620 TL / Mekanik salmastra fiyat farkı: 65 EURO

TİP TYPE	Bağlantı Giriş x Çıkış Inlet x Outlet	MOTOR			m ³ /h Hm (mSS)	Debi (Q) - Capacity						FİYAT - PRICE (TL)		
		HP	kW	V		30	45	60	75	90	105	Tek Pompa Bare Pump	Şasi & Kaplin Base & Coupling	Pompa & Mot. Akuple Pump & Mot. Coupled
ES50-32 30002	2.5" x 2"	40	30	380/660	Hm (mSS)	88	87	83	72	52		38.570 ₺	3.365 ₺	117.560 ₺
ES50-32 37002		50	37			99	98	95	87	68		38.570 ₺	3.365 ₺	127.045 ₺
ES50-32 45002		60	45			112	111	107	99	84	52	38.650 ₺	4.570 ₺	136.220 ₺
ES50-32 55002		75	55			135	134	131	125	112	90	38.650 ₺	6.230 ₺	FİYAT SORUNUZ
ES50-32 75002		100	75			147	146	144	138	128	112	38.735 ₺	8.285 ₺	FİYAT SORUNUZ

Flanşlar hariçtir. Takım fiyatı (Flange Set): 1.620 TL / Mekanik salmastra fiyat farkı: 74 EURO



ES50 (3000 d/d) (Yumuşak veya Mekanik Salmastralı) **SALYANGOZ KAPLINLİ POMPALAR**

VOLUTE CASING LONG-COUPLED PUMPS (Soft Packing / Mechanical Seal)

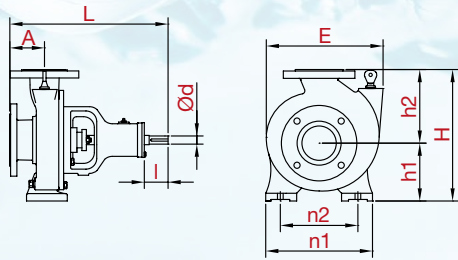
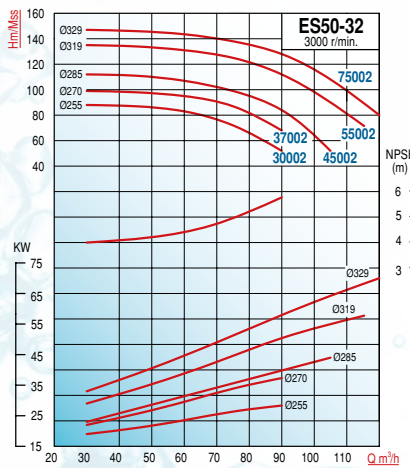
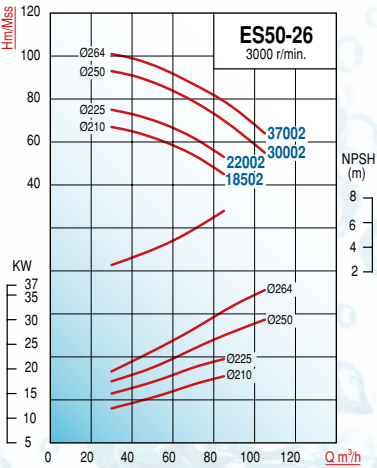
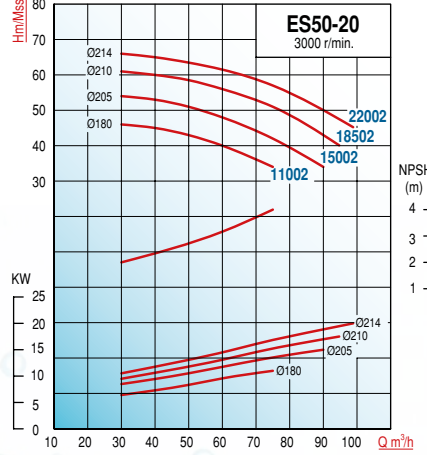
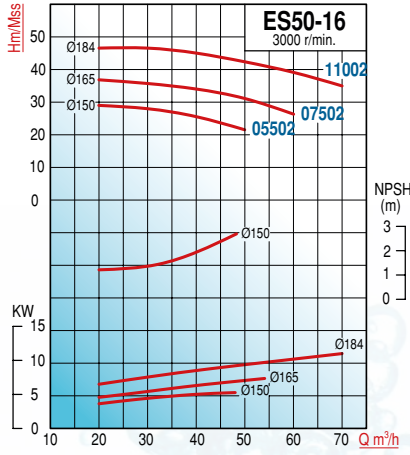

TİP TYPE	Boyutlar - Dimensions (mm)										Ağırlık - Weight Kg
	A	L	h1	h2	H	E	n1	n2	l	d	
ES50-16	100	465	160	180	340	271	265	212	55	24	40
ES50-20	100	460	160	200	360	305	265	212	55	24	47
ES50-26	100	460	180	225	405	335	320	250	55	24	62
ES50-32	125	595	225	280	507	417	345	280	80	32	90

ES65 (3000 d/d) (Yumuşak veya Mekanik Salmastralı) SALYANGOZ KAPLINLI POMPALAR

VOLUTE CASING LONG-COUPLED PUMPS (Soft Packing / Mechanical Seal)

TİP TYPE	Bağlantı Giriş x Çıkış Inlet x Outlet	MOTOR			m ³ /h Hm (mSS)	Debi (Q) - Capacity						FİYAT - PRICE (TL)		
		HP	kW	V		30	60	90	110	125	140	Tek Pompa Bare Pump	Şasi & Kaplin Base & Coupling	Pompa & Mot. Akuple Pump & Mot. Coupled
	ES65-16 07502	3" x 2.5"	10	7,5		380/660	30	26	18	13	7		29.475 ₺	1.865 ₺
ES65-16 11002	15		11	36	33		26	22	17	5	29.475 ₺	2.155 ₺	57.805 ₺	
ES65-16 15002	20		15	42	38		33	27	22	16	29.475 ₺	2.770 ₺	66.275 ₺	

Flaşlar hariçtir. Takım fiyatı (Flange Set): 2.060 TL / Mekanik salmastra fiyat farkı: 65 EURO

TİP TYPE	Bağlantı Giriş x Çıkış Inlet x Outlet	MOTOR			m ³ /h Hm (mSS)	Debi (Q) - Capacity						FİYAT - PRICE (TL)		
		HP	kW	V		80	100	125	140	150	155	Tek Pompa Bare Pump	Şasi & Kaplin Base & Coupling	Pompa & Mot. Akuple Pump & Mot. Coupled
	ES65-20 15002	3" x 2.5"	20	15		380/660	33	31	27	20	11	2	30.720 ₺	2.665 ₺
ES65-20 18502	25		18,5	44	40		34	28	22	15	30.720 ₺	2.665 ₺	74.580 ₺	
ES65-20 22002	30		22	48	44		38	32	26	17	30.720 ₺	2.665 ₺	84.640 ₺	
ES65-20 30002	40		30	57	53		48	43	36	25	30.720 ₺	3.350 ₺	109.695 ₺	
ES65-20 37002	50		37	63	61		56	50	44	31	30.720 ₺	3.350 ₺	119.180 ₺	

Flaşlar hariçtir. Takım fiyatı (Flange Set): 2.060 TL / Mekanik salmastra fiyat farkı: 65 EURO

TİP TYPE	Bağlantı Giriş x Çıkış Inlet x Outlet	MOTOR			m ³ /h Hm (mSS)	Debi (Q) - Capacity						FİYAT - PRICE (TL)		
		HP	kW	V		30	50	125	150	155	160	Tek Pompa Bare Pump	Şasi & Kaplin Base & Coupling	Pompa & Mot. Akuple Pump & Mot. Coupled
	ES65-26 22002	3" x 2.5"	30	22		380 / 660	59	58	43	25	17	2	35.300 ₺	2.785 ₺
ES65-26 30002	40		30	65	64		52	39	32	12	35.385 ₺	3.365 ₺	114.370 ₺	
ES65-26 37002	50		37	81	80		67	55	50	40	35.385 ₺	3.365 ₺	123.855 ₺	
ES65-26 45002	60		45	91	90		88	72	66	60	35.545 ₺	4.800 ₺	133.345 ₺	
ES65-26 55002	75		55	99	98		90	80	76	70	35.545 ₺	5.825 ₺	FİYAT SORUNUZ	

Flaşlar hariçtir. Takım fiyatı (Flange Set): 2.060 TL / Mekanik salmastra fiyat farkı: 74 EURO

TİP TYPE	Bağlantı Giriş x Çıkış Inlet x Outlet	MOTOR			m ³ /h Hm (mSS)	Debi (Q) - Capacity						FİYAT - PRICE (TL)		
		HP	kW	V		90	125	145	150	155	160	Tek Pompa Bare Pump	Şasi & Kaplin Base & Coupling	Pompa & Mot. Akuple Pump & Mot. Coupled
	ES65-32 45002	3" x 2.5"	60	45		380/660	81	75	60	54	44	11	41.730 ₺	4.570 ₺
ES65-32 55002	75		55	95	88		70	63	54	43	41.730 ₺	6.230 ₺	FİYAT SORUNUZ	
ES65-32 75002	100		75	120	106		80	70	60	47	41.810 ₺	8.285 ₺	FİYAT SORUNUZ	
ES65-32 90002	125		90	132	120		106	100	90	85	41.810 ₺	8.285 ₺	FİYAT SORUNUZ	

Flaşlar hariçtir. Takım fiyatı (Flange Set): 2.060 TL / Mekanik salmastra fiyat farkı: 74 EURO



ES65 (3000 d/d) (Yumuşak veya Mekanik Salmastralı) **SALYANGOZ KAPLINLİ POMPALAR**

VOLUTE CASING LONG-COUPLED PUMPS (Soft Packing / Mechanical Seal)

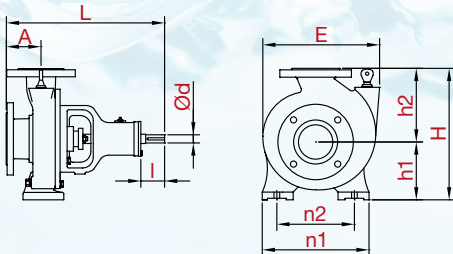
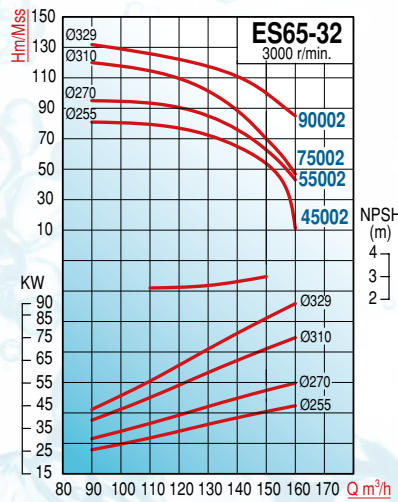
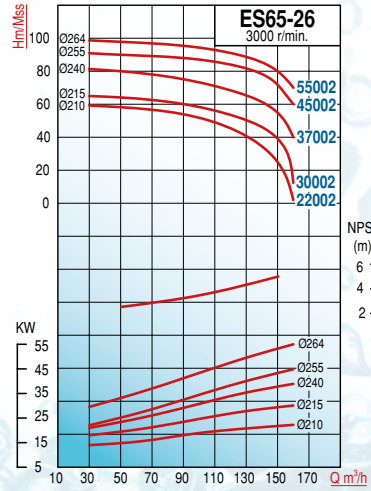
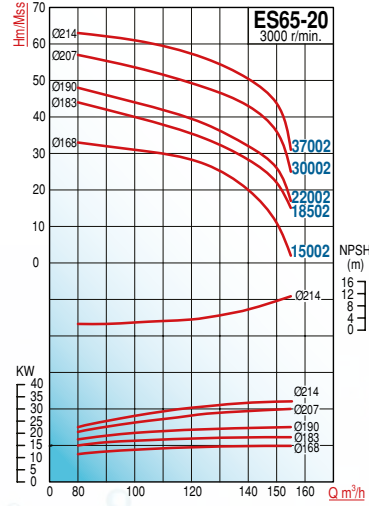
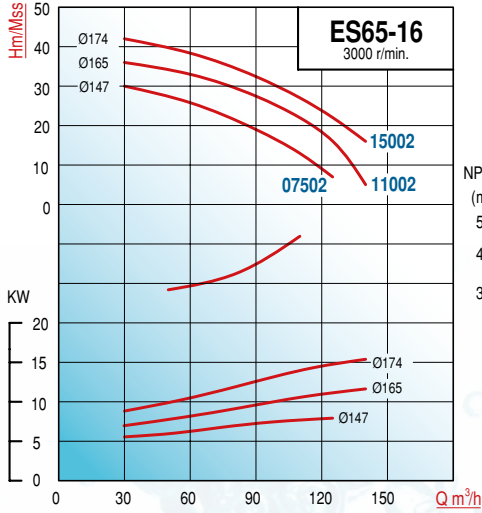

TİP TYPE	Boyutlar - Dimensions (mm)										Ağırlık - Weight
	A	L	h1	h2	H	E	n1	n2	I	d	Kg
ES65-16	100	460	160	180	340	285	280	212	50	24	47
ES65-20	100	460	180	225	405	335	320	250	55	24	52
ES65-26	100	570	200	250	450	375	360	280	84	32	81
ES65-32	125	595	225	280	505	415	400	315	84	32	106



ES80 (3000 d/d) (Yumuşak veya Mekanik Salmastralı) SALYANGOZ KAPLINLİ POMPALAR

VOLUTE CASING LONG-COUPLED PUMPS (Soft Packing / Mechanical Seal)

TİP TYPE	Bağlantı		MOTOR			m ³ /h Hm (mSS)	Debi (Q) - Capacity						FİYAT - PRICE (TL)		
	Giriş x Çıkış	HP	kW	V	70		100	130	160	190	220	Tek Pompa Bare Pump	Şasi & Kaplin Base & Coupling	Pompa & Mot. Akuple Pump & Mot. Coupled	
	Inlet x Outlet														
ES80-16 11002	4"x3"	15	11	380/660	26	25	23	19	13		30.355 ₺	2.315 ₺	58.850 ₺		
ES80-16 15002		20	15		30	29	28	25	20	13	30.355 ₺	2.770 ₺	67.155 ₺		
ES80-16 18502		25	18,5		34	33	32	29	25	18	30.355 ₺	2.770 ₺	74.320 ₺		
ES80-16 22002		30	22		38	37	36	33	29	23	30.355 ₺	2.770 ₺	84.380 ₺		

Flanşlar hariçtir. Takım fiyatı (Flange Set): 2.645 TL / Mekanik salmastra fiyat farkı: 65 EURO

TİP TYPE	Bağlantı		MOTOR			m ³ /h Hm (mSS)	Debi (Q) - Capacity						FİYAT - PRICE (TL)		
	Giriş x Çıkış	HP	kW	V	90		120	150	180	210	240	Tek Pompa Bare Pump	Şasi & Kaplin Base & Coupling	Pompa & Mot. Akuple Pump & Mot. Coupled	
	Inlet x Outlet														
ES80-20 18502	4" x 3"	25	18,5	380 / 660	41	39	35	29	20		32.910 ₺	2.785 ₺	76.890 ₺		
ES80-20 22002		30	22		47	46	44	40	33		32.910 ₺	2.785 ₺	86.950 ₺		
ES80-20 30002		40	30		53	52	50	46	40	32	32.990 ₺	3.365 ₺	111.975 ₺		
ES80-20 37002		50	37		58	57	55	52	47	40	32.990 ₺	3.365 ₺	121.460 ₺		
ES80-20 45002		60	45		64	63	62	59	54	46	33.070 ₺	4.570 ₺	130.640 ₺		

Flanşlar hariçtir. Takım fiyatı (Flange Set): 2.645 TL / Mekanik salmastra fiyat farkı: 74 EURO

TİP TYPE	Bağlantı		MOTOR			m ³ /h Hm (mSS)	Debi (Q) - Capacity						FİYAT - PRICE (TL)		
	Giriş x Çıkış	HP	kW	V	70		100	130	160	190	220	Tek Pompa Bare Pump	Şasi & Kaplin Base & Coupling	Pompa & Mot. Akuple Pump & Mot. Coupled	
	Inlet x Outlet														
ES80-26 30002	4" x 3"	40	30	380 / 660	59	58	55	50	41		36.940 ₺	3.365 ₺	115.930 ₺		
ES80-26 37002		50	37		64	63	61	57	49		36.940 ₺	3.365 ₺	125.415 ₺		
ES80-26 45002		60	45		70	69	67	63	57	48	37.020 ₺	4.570 ₺	134.590 ₺		
ES80-26 55002		75	55		81	80	78	74	68	60	37.020 ₺	6.230 ₺	FİYAT SORUNUZ		
ES80-26 75002		100	75		99	98	95	91	86	80	37.105 ₺	8.285 ₺	FİYAT SORUNUZ		

Flanşlar hariçtir. Takım fiyatı (Flange Set): 2.645 TL / Mekanik salmastra fiyat farkı: 74 EURO



ES80 (3000 d/d) (Yumuşak veya Mekanik Salmastralı) **SALYANGOZ KAPLINLİ POMPALAR**

VOLUTE CASING LONG-COUPLED PUMPS (Soft Packing / Mechanical Seal)

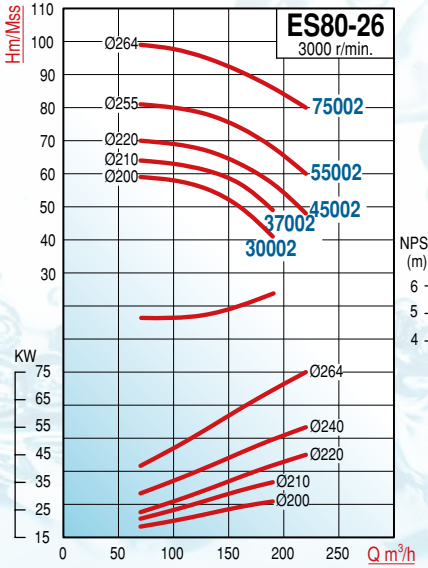
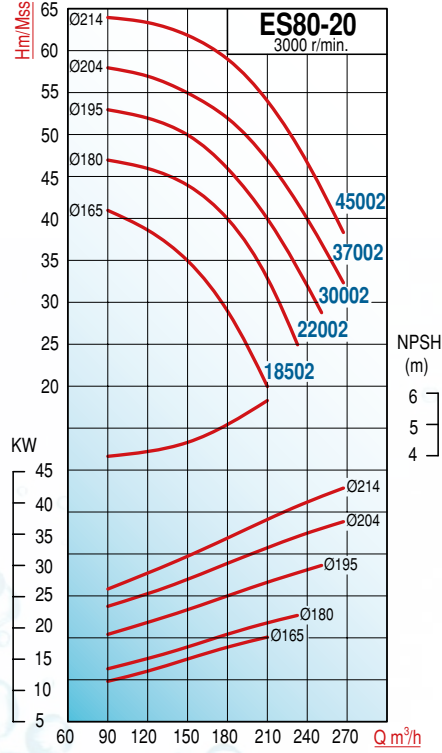
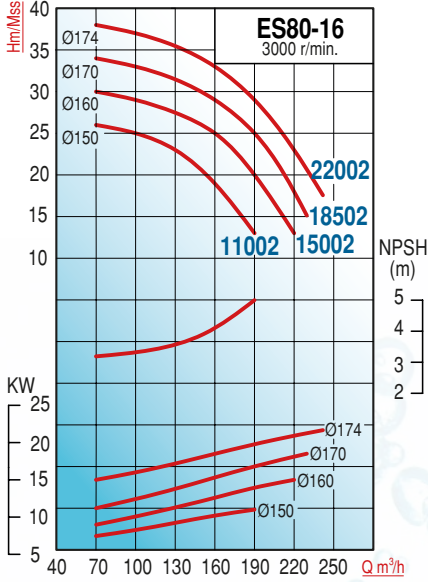

TİP TYPE	Boyutlar - Dimensions (mm)										Ağırlık - Weight
	A	L	h1	h2	H	E	n1	n2	l	d	Kg
ES80-16	125	485	180	225	405	350	320	250	50	24	51
ES80-20	125	595	180	250	430	385	345	280	84	32	65
ES80-26	125	595	200	280	480	420	400	315	84	32	86
ES80-32	125	595	250	315	565	445	400	315	84	32	92

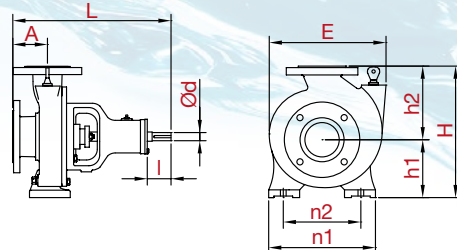

ES100 (3000 d/d) (Yumuşak veya Mekanik Salmastralı) SALYANGOZ KAPLINLI POMPALAR

VOLUTE CASING LONG-COUPLED PUMPS (Soft Packing / Mechanical Seal)

TİP TYPE	Bağlantı Giriş x Çıkış Inlet x Outlet	MOTOR			m ³ /h	Debi (Q) - Capacity						FİYAT - PRICE (TL)			
		HP	kW	V		Hm (mss)	120	160	200	240	280	320	Tek Pompa Bare Pump	Şasi & Kaplin Base & Coupling	Pompa & Mot. Akuple Pump & Mot. Coupled
ES100-20 30002	5" x 4"	40	30	380 / 660	Hm (mss)	43	41	38	35	30		35.075 ₺	3.365 ₺	114.065 ₺	
ES100-20 37002		50	37			49	47	44	41	36	30	35.075 ₺	3.365 ₺	123.550 ₺	
ES100-20 45002		60	45			55	53	51	47	42	35	35.160 ₺	4.570 ₺	132.725 ₺	
ES100-20 55002		75	55			63	61	58	54	50	44	35.160 ₺	6.230 ₺	FİYAT SORUNUZ	

Flanşlar hariçtir. Takım fiyatı (Flange Set): 3.235 TL / Mekanik salmastra fiyat farkı: 74 EURO

TİP TYPE	Bağlantı Giriş x Çıkış Inlet x Outlet	MOTOR			m ³ /h	Debi (Q) - Capacity						FİYAT - PRICE (TL)			
		HP	kW	V		Hm (mss)	70	160	200	240	280	320	Tek Pompa Bare Pump	Şasi & Kaplin Base & Coupling	Pompa & Mot. Akuple Pump & Mot. Coupled
ES100-26 55002	5" x 4"	75	55	380 / 660	Hm (mss)	68	67	63	56	44		39.000 ₺	6.230 ₺	FİYAT SORUNUZ	
ES100-26 75002		100	75			81	80	77	72	64	52	39.085 ₺	8.285 ₺	FİYAT SORUNUZ	
ES100-26 90002		125	90			100	98	97	95	93	90	39.085 ₺	8.285 ₺	FİYAT SORUNUZ	

Flanşlar hariçtir. Takım fiyatı (Flange Set): 3.235 TL / Mekanik salmastra fiyat farkı: 74 EURO

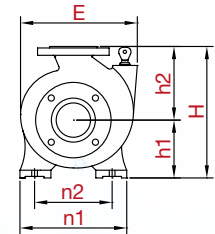
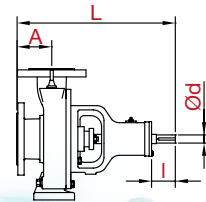
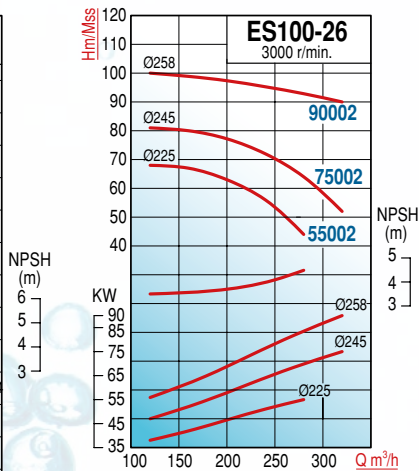
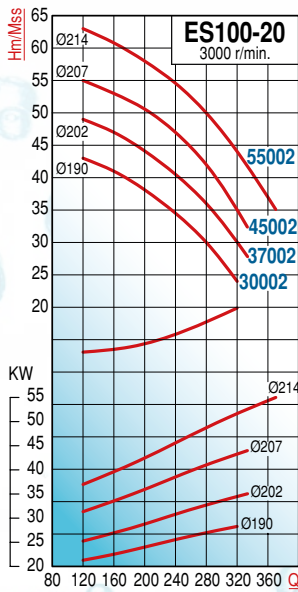

TİP TYPE	Boyutlar - Dimensions (mm)										Ağırlık - Weight Kg
	A	L	h1	h2	H	E	n1	n2	l	d	
ES100-20	125	595	200	280	480	385	360	280	84	32	75
ES100-26	140	610	225	280	505	420	400	315	84	32	96

ES40 (1500 d/d) (Yumuşak veya Mekanik Salmastralı) SALYANGOZ KAPLINLİ POMPALAR

1500 d/d

VOLUTE CASING LONG-COUPLED PUMPS (Soft Packing / Mechanical Seal)

TİP TYPE	Bağlantı Giriş x Çıkış Inlet x Outlet	MOTOR			m ³ /h	Debi (Q) - Capacity						FİYAT - PRICE (TL)			
		HP	kW	V		Hm (mSS)	4	8	12	15	18	23	Tek Pompa Bare Pump	Şasi & Kaplin Base & Coupling	Pompa & Mot. Akuple Pump & Mot. Coupled
ES40-16 00554	2.5"x1.5"	0,75	0,55	380	Hm (mSS)	8,5	8	7,5	6,5	2		27.460 ₺	1.595 ₺	34.010 ₺	
ES40-16 00754		1	0,75			11	10,5	10	9	8	3	27.460 ₺	1.595 ₺	35.375 ₺	
ES40-16 01104		1,5	1,1			12,5	12	11,5	11	10,5	8,5	27.460 ₺	1.595 ₺	36.670 ₺	

Flanşlar hariçtir. Takım fiyatı (Flange Set): 1.515 TL / Mekanik salmastra fiyat farkı: 65 EURO

TİP TYPE	Bağlantı Giriş x Çıkış Inlet x Outlet	MOTOR			m ³ /h	Debi (Q) - Capacity						FİYAT - PRICE (TL)			
		HP	kW	V		Hm (mSS)	8	12	14	16	18	20	Tek Pompa Bare Pump	Şasi & Kaplin Base & Coupling	Pompa & Mot. Akuple Pump & Mot. Coupled
ES40-20 00754	2.5" x 1.5"	1	0,75	380	Hm (mSS)	10	9,5	9	8	7		28.330 ₺	1.595 ₺	36.245 ₺	
ES40-20 01104		1,5	1,1			13,5	13	12,5	11,5	10,5	9	28.330 ₺	1.595 ₺	37.540 ₺	
ES40-20 01504		2	1,5			16	15,5	15	14	13	11,5	28.330 ₺	1.595 ₺	38.970 ₺	

Flanşlar hariçtir. Takım fiyatı (Flange Set): 1.515 TL / Mekanik salmastra fiyat farkı: 65 EURO

TİP TYPE	Bağlantı Giriş x Çıkış Inlet x Outlet	MOTOR			m ³ /h	Debi (Q) - Capacity						FİYAT - PRICE (TL)			
		HP	kW	V		Hm (mSS)	9	12	15	18	23	25	Tek Pompa Bare Pump	Şasi & Kaplin Base & Coupling	Pompa & Mot. Akuple Pump & Mot. Coupled
ES40-26 01104	2.5" x 1.5"	1,5	1,1	380	Hm (mSS)	12	11,5	11	10			31.890 ₺	1.865 ₺	41.370 ₺	
ES40-26 01504		2	1,5			16	15	14,5	13,5	11		31.890 ₺	1.865 ₺	42.800 ₺	
ES40-26 02204		3	2,2			20	19,5	19	18	15,5		31.890 ₺	1.865 ₺	44.755 ₺	
ES40-26 03004		4	3			24,5	24	23,5	22,5	19,5	18	31.890 ₺	1.865 ₺	46.285 ₺	

Flanşlar hariçtir. Takım fiyatı (Flange Set): 1.515 TL / Mekanik salmastra fiyat farkı: 65 EURO

TİP TYPE	Bağlantı Giriş x Çıkış Inlet x Outlet	MOTOR			m ³ /h	Debi (Q) - Capacity						FİYAT - PRICE (TL)			
		HP	kW	V		Hm (mSS)	10	14	18	22	26	30	Tek Pompa Bare Pump	Şasi & Kaplin Base & Coupling	Pompa & Mot. Akuple Pump & Mot. Coupled
ES40-32 02204	2.5" x 1.5"	3	2,2	380	Hm (mSS)	20	19	17	14			38.075 ₺	2.030 ₺	51.105 ₺	
ES40-32 03004		4	3			26	25	23	20,5	16		38.075 ₺	2.030 ₺	52.635 ₺	
ES40-32 04004		5,5	4	380/660		31	30	28,5	26	23	17		38.075 ₺	2.030 ₺	55.695 ₺
ES40-32 05504		7,5	5,5			38	37	35	32	28	23	38.075 ₺	2.030 ₺	58.795 ₺	

Flanşlar hariçtir. Takım fiyatı (Flange Set): 1.515 TL / Mekanik salmastra fiyat farkı: 74 EURO



ES40 (1500 d/d) (Yumuşak veya Mekanik Salmastralı) SALYANGOZ KAPLINLİ POMPALAR

1500 d/d

VOLUTE CASING LONG-COUPLED PUMPS (Soft Packing / Mechanical Seal)

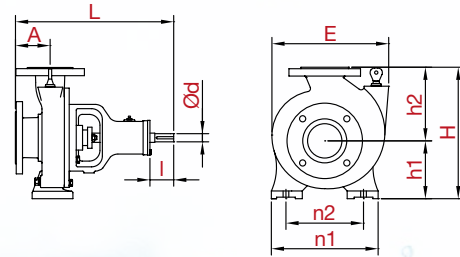
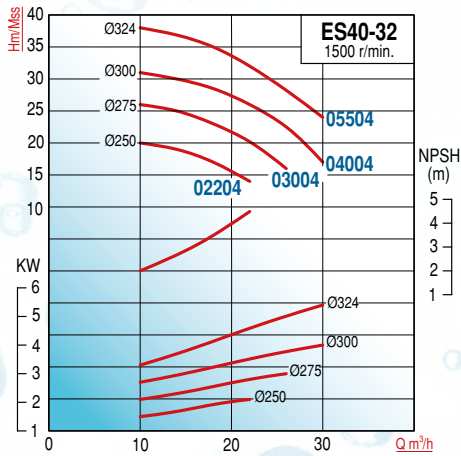
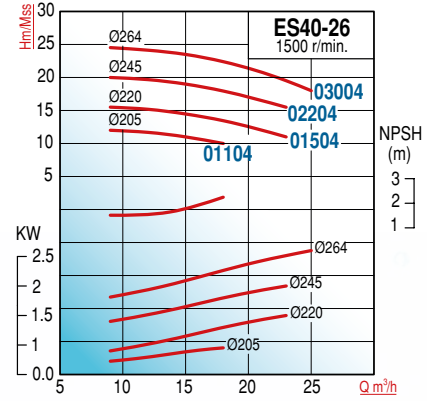
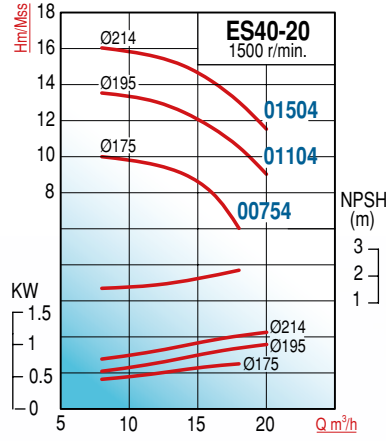
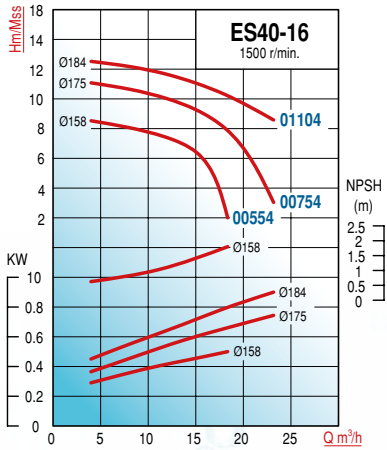

TİP TYPE	Boyutlar - Dimensions (mm)										Ağırlık - Weight	
	A	L	h1	h2	H	E	n1	n2	I	d	Kg	
ES40-16	80	445	132	160	192	246	240	190	55	24	35	
ES40-20	100	460	160	180	340	290	265	212	55	24	42	
ES40-26	100	460	180	225	405	340	320	250	55	24	59	
ES40-32	125	595	200	250	450	400	345	280	80	32	87	

ES50 (1500 d/d) (Yumuşak veya Mekanik Salmastralı) SALYANGOZ KAPLINLİ POMPALAR

1500 d/d

VOLUTE CASING LONG-COUPLED PUMPS (Soft Packing / Mechanical Seal)

TİP TYPE	Bağlantı Giriş x Çıkış Inlet x Outlet	MOTOR			m ³ /h	Debi (Q) - Capacity						FİYAT - PRICE (TL)			
		HP	kW	V		Hm (mSS)	5	10	15	20	25	30	Tek Pompa Bare Pump	Şasi & Kaplin Base & Coupling	Pompa & Mot. Akuple Pump & Mot. Coupled
ES50-16 00754	2.5" x 2"	1	0,75	380	Hm (mSS)	8,5	8	8	7	6		27.990 ₺	1.595 ₺	35.905 ₺	
ES50-16 01104		1,5	1,1			10	10	9,5	9	8,5	7,5	27.990 ₺	1.595 ₺	37.205 ₺	
ES50-16 01504		2	1,5			11,5	11,5	11	10,5	9,5	9	27.990 ₺	1.595 ₺	38.630 ₺	

Flanşlar hariçtir. Takım fiyatı (Flange Set): 1.620 TL / Mekanik salmastra fiyat farkı: 65 EURO

TİP TYPE	Bağlantı Giriş x Çıkış Inlet x Outlet	MOTOR			m ³ /h	Debi (Q) - Capacity						FİYAT - PRICE (TL)				
		HP	kW	V		Hm (mSS)	15	20	25	30	35	40	Tek Pompa Bare Pump	Şasi & Kaplin Base & Coupling	Pompa & Mot. Akuple Pump & Mot. Coupled	
ES50-20 01104	2.5" x 2"	1.5	1.1	380	Hm (mSS)	10.5	10	9	8			29.045 ₺	1.650 ₺	38.310 ₺		
ES50-20 01504		2	1.5			12.5	12.2	11.5	10.5	9.5			29.045 ₺	1.650 ₺	39.735 ₺	
ES50-20 02204		3	2.2			15	14.5	14	13.5	12.5	11			29.045 ₺	1.650 ₺	41.695 ₺
ES50-20 03004		4	3			16.5	16	15.5	15	14	12.5			29.045 ₺	1.650 ₺	43.225 ₺

Flanşlar hariçtir. Takım fiyatı (Flange Set): 1.620 TL / Mekanik salmastra fiyat farkı: 65 EURO

TİP TYPE	Bağlantı Giriş x Çıkış Inlet x Outlet	MOTOR			m ³ /h	Debi (Q) - Capacity						FİYAT - PRICE (TL)			
		HP	kW	V		Hm (mSS)	15	25	30	35	40	50	Tek Pompa Bare Pump	Şasi & Kaplin Base & Coupling	Pompa & Mot. Akuple Pump & Mot. Coupled
ES50-26 02204	2.5" x 2"	3	2,2	380	Hm (mSS)	15,5	14,5	13	11			32.295 ₺	1.650 ₺	44.945 ₺	
ES50-26 03004		4	3			19,5	19	18	16,5	14,5			32.295 ₺	1.650 ₺	46.480 ₺
ES50-26 04004		5,5	4			22,5	22	21,5	21	20	17			32.295 ₺	1.650 ₺
ES50-26 05504		7,5	5,5	24,5		24	23,5	23	22	19			32.295 ₺	1.650 ₺	52.635 ₺

Flanşlar hariçtir. Takım fiyatı (Flange Set): 1.620 TL / Mekanik salmastra fiyat farkı: 65 EURO

TİP TYPE	Bağlantı Giriş x Çıkış Inlet x Outlet	MOTOR			m ³ /h	Debi (Q) - Capacity						FİYAT - PRICE (TL)				
		HP	kW	V		Hm (mSS)	15	25	35	45	55	65	Tek Pompa Bare Pump	Şasi & Kaplin Base & Coupling	Pompa & Mot. Akuple Pump & Mot. Coupled	
ES50-32 04004	2.5" x 2"	5,5	4	380 / 660	Hm (mSS)	25	24	22	19,5	16		38.310 ₺	2.030 ₺	55.930 ₺		
ES50-32 05504		7,5	5,5			29	28	26,5	24	21			38.310 ₺	2.030 ₺	59.030 ₺	
ES50-32 07504		10	7,5			34	33	31	29	26	22			38.310 ₺	2.030 ₺	63.075 ₺
ES50-32 11004		15	11			37	36	34,5	32	29,5	25			38.310 ₺	2.315 ₺	74.755 ₺

Flanşlar hariçtir. Takım fiyatı (Flange Set): 1.620 TL / Mekanik salmastra fiyat farkı: 74 EURO



ES50 (1500 d/d) (Yumuşak veya Mekanik Salmastralı) SALYANGOZ KAPLINLİ POMPALAR

1500 d/d

VOLUTE CASING LONG-COUPLED PUMPS (Soft Packing / Mechanical Seal)

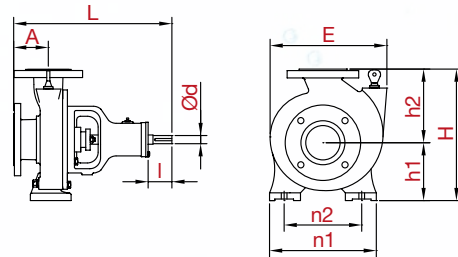
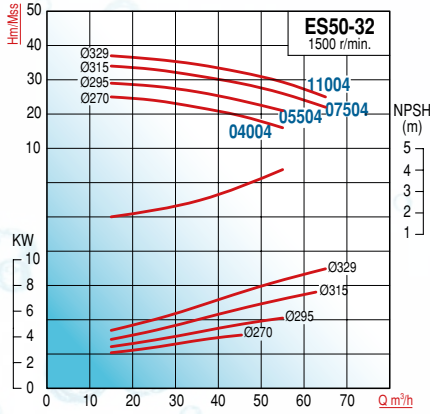
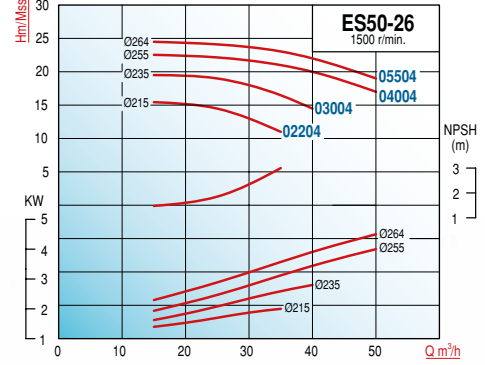
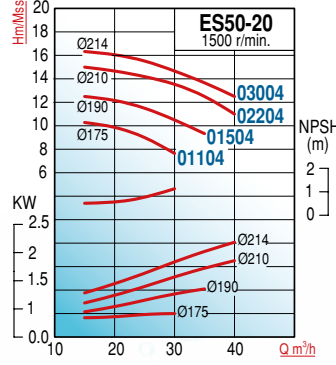
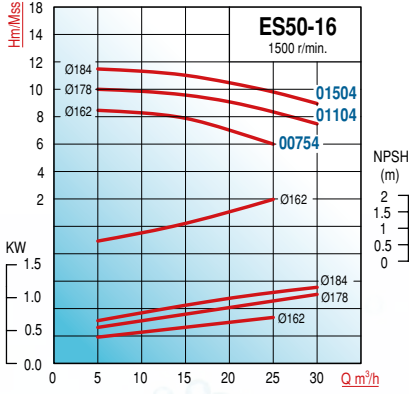

TİP TYPE	Boyutlar - Dimensions (mm)										Ağırlık - Weight
	A	L	h1	h2	H	E	n1	n2	I	d	Kg
ES50-16	100	465	160	180	340	271	265	212	55	24	40
ES50-20	100	460	160	200	360	305	265	212	55	24	47
ES50-26	100	460	180	225	405	335	320	250	55	24	62
ES50-32	125	595	225	280	507	417	345	280	80	32	90

ES65 (1500 d/d) (Yumuşak veya Mekanik Salmastralı) SALYANGOZ KAPLINLİ POMPALAR

1500 d/d

VOLUTE CASING LONG-COUPLED PUMPS (Soft Packing / Mechanical Seal)

TİP TYPE	Bağlantı Giriş x Çıkış Inlet x Outlet	MOTOR			m ³ /h	Debi (Q) - Capacity						FİYAT - PRICE (TL)			
		HP	kW	V		Hm (mSS)	10	20	30	40	50	60	Tek Pompa Bare Pump	Şasi & Kaplin Base & Coupling	Pompa & Mot. Akuple Pump & Mot. Coupled
							380	8	7,5	7	6	4			
ES65-16 01104	3"x2.5"	1,5	1,1	380	8	7,5	7	6	4		29.475 ₺	1.595 ₺	38.685 ₺		
ES65-16 01504		2	1,5	380	9	8,5	8	7,5	6	4	29.475 ₺	1.595 ₺	40.115 ₺		
ES65-16 02204		3	2,2	380	11,5	11	10,5	10	9	8	29.475 ₺	1.595 ₺	42.070 ₺		

Flaşlar hariçtir. Takım fiyatı (Flange Set): 2.060 TL / Mekanik salmastra fiyat farkı: 65 EURO

TİP TYPE	Bağlantı Giriş x Çıkış Inlet x Outlet	MOTOR			m ³ /h	Debi (Q) - Capacity						FİYAT - PRICE (TL)			
		HP	kW	V		Hm (mSS)	15	30	45	60	75	90	Tek Pompa Bare Pump	Şasi & Kaplin Base & Coupling	Pompa & Mot. Akuple Pump & Mot. Coupled
							380	9	8,5	7	5				
ES65-20 01504	3" x 2.5"	2	1.5	380	9	8,5	7	5			30.640 ₺	1.650 ₺	41.330 ₺		
ES65-20 02204		3	2.2	380	11	10.5	9.5	7.5			30.640 ₺	1.650 ₺	43.290 ₺		
ES65-20 03004		4	3	380	14	13.5	12.5	11	8.5		30.640 ₺	1.650 ₺	44.820 ₺		
ES65-20 04004		5.5	4	380/660	16	15.5	14.5	13	11	8	30.640 ₺	1.650 ₺	47.880 ₺		

Flaşlar hariçtir. Takım fiyatı (Flange Set): 2.060 TL / Mekanik salmastra fiyat farkı: 65 EURO

TİP TYPE	Bağlantı Giriş x Çıkış Inlet x Outlet	MOTOR			m ³ /h	Debi (Q) - Capacity						FİYAT - PRICE (TL)			
		HP	kW	V		Hm (mSS)	20	35	45	55	65	75	Tek Pompa Bare Pump	Şasi & Kaplin Base & Coupling	Pompa & Mot. Akuple Pump & Mot. Coupled
							380	16	15.5	14.5	12.5				
ES65-26 03004	3" x 2.5"	4	3	380	16	15.5	14.5	12.5			35.300 ₺	2.030 ₺	49.865 ₺		
ES65-26 04004		5.5	4	380 / 660	19.5	19	17.5	16	14		35.300 ₺	2.030 ₺	52.925 ₺		
ES65-26 05504		7.5	5.5	380 / 660	22.5	22	21	20	19	17.5	35.300 ₺	2.030 ₺	56.020 ₺		
ES65-26 07504		10	7.5	380 / 660	25	24.5	24	23	22	20	35.300 ₺	2.030 ₺	60.065 ₺		

Flaşlar hariçtir. Takım fiyatı (Flange Set): 2.060 TL / Mekanik salmastra fiyat farkı: 74 EURO

TİP TYPE	Bağlantı Giriş x Çıkış Inlet x Outlet	MOTOR			m ³ /h	Debi (Q) - Capacity						FİYAT - PRICE (TL)			
		HP	kW	V		Hm (mSS)	30	45	60	75	90	105	Tek Pompa Bare Pump	Şasi & Kaplin Base & Coupling	Pompa & Mot. Akuple Pump & Mot. Coupled
							380/660	22	21	19	15				
ES65-32 05504	3" x 2.5"	7.5	5.5	380/660	22	21	19	15			41.565 ₺	2.150 ₺	62.405 ₺		
ES65-32 07504		10	7.5	380/660	27.5	27	25.5	22.5	15		41.565 ₺	2.150 ₺	66.455 ₺		
ES65-32 11004		15	11	380/660	34	33	31	28	22.5	13	41.565 ₺	2.440 ₺	78.130 ₺		
ES65-32 15004		20	15	380/660	37.5	36.5	35	32.5	27.5	20	41.565 ₺	2.785 ₺	86.940 ₺		

Flaşlar hariçtir. Takım fiyatı (Flange Set): 2.060 TL / Mekanik salmastra fiyat farkı: 74 EURO



ES65 (1500 d/d) (Yumuşak veya Mekanik Salmastralı) SALYANGOZ KAPLINLİ POMPALAR

1500 d/d

VOLUTE CASING LONG-COUPLED PUMPS (Soft Packing / Mechanical Seal)

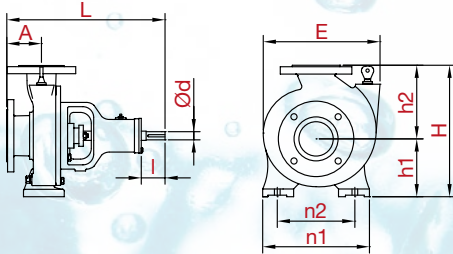
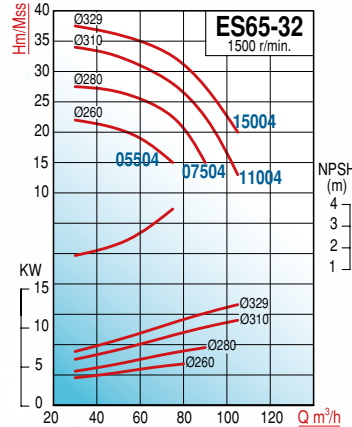
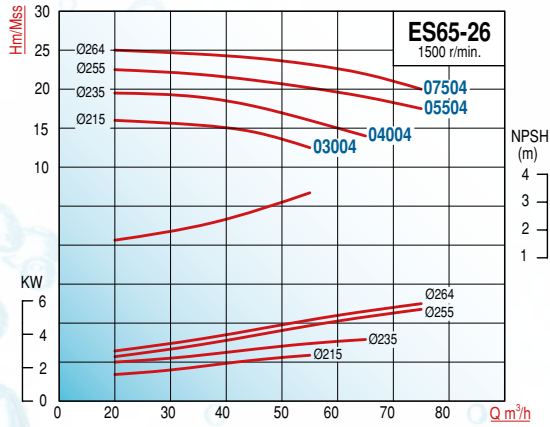
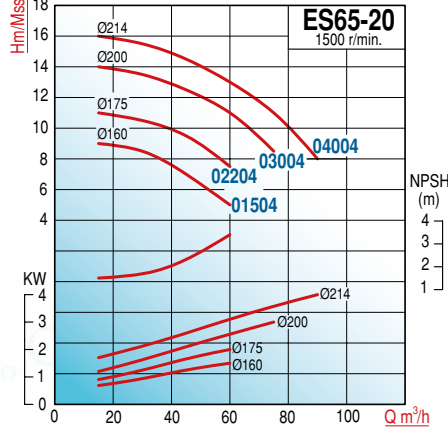
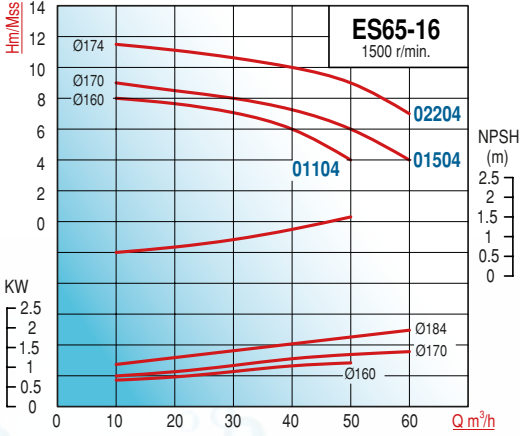

TİP TYPE	Boyutlar - Dimensions (mm)										Ağırlık - Weight	
	A	L	h1	h2	H	E	n1	n2	i	d	Kg	
ES65-16	100	460	160	180	340	285	280	212	50	24	47	
ES65-20	100	460	180	225	405	335	320	250	55	24	52	
ES65-26	100	570	200	250	450	375	360	280	84	32	81	
ES65-32	125	595	225	280	505	415	400	315	84	32	106	

ES80 (1500 d/d) (Yumuşak veya Mekanik Salmastralı) SALYANGOZ KAPLINLİ POMPALAR

1500 d/d

VOLUTE CASING LONG-COUPLED PUMPS (Soft Packing / Mechanical Seal)

TİP TYPE	Bağlantı Giriş x Çıkış Inlet x Outlet	MOTOR			m ³ /h	Debi (Q) - Capacity						FİYAT - PRICE (TL)		
		HP	kW	V		30	40	50	60	70	80	Tek Pompa Bare Pump	Şasi & Kaplin Base & Coupling	Pompa & Mot. Akuple Pump & Mot. Coupled
ES80-16 01504	4" x 3"	2	1,5	380	Hm (mSS)	8,5	7,5	6,5	5,5	4		30.355 ₺	1.650 ₺	41.045 ₺
ES80-16 02204		3	2,2			10,5	10	9,5	8,5	7,5	6	30.355 ₺	1.650 ₺	43.005 ₺
ES80-16 03004		4	3			12	11,5	11	10	9	7,5	30.355 ₺	1.650 ₺	44.535 ₺

Flanşlar hariçtir. Takım fiyatı (Flange Set): 2.645 TL / Mekanik salmastra fiyat farkı: 65 EURO

TİP TYPE	Bağlantı Giriş x Çıkış Inlet x Outlet	MOTOR			m ³ /h	Debi (Q) - Capacity						FİYAT - PRICE (TL)		
		HP	kW	V		40	55	70	85	100	115	Tek Pompa Bare Pump	Şasi & Kaplin Base & Coupling	Pompa & Mot. Akuple Pump & Mot. Coupled
ES80-20 03004	4" x 3"	4	3	380	Hm (mSS)	11	10,5	10	9	7,5		32.910 ₺	2.030 ₺	47.470 ₺
ES80-20 04004		5,5	4	380/660		13	12,5	12	11,5	10,5		32.910 ₺	2.030 ₺	50.530 ₺
ES80-20 05504		7,5	5,5	380/660		15,5	15	14,5	14	13	12		32.990 ₺	2.030 ₺

Flanşlar hariçtir. Takım fiyatı (Flange Set): 2.645 TL / Mekanik salmastra fiyat farkı: 74 EURO

TİP TYPE	Bağlantı Giriş x Çıkış Inlet x Outlet	MOTOR			m ³ /h	Debi (Q) - Capacity						FİYAT - PRICE (TL)			
		HP	kW	V		40	60	80	100	115	130	Tek Pompa Bare Pump	Şasi & Kaplin Base & Coupling	Pompa & Mot. Akuple Pump & Mot. Coupled	
ES80-26 04004	4" x 3"	5,5	4	380/660	Hm (mSS)	15	14,5	13,5				36.780 ₺	2.135 ₺	54.505 ₺	
ES80-26 05504		7,5	5,5			17,5	17	16	15	13		36.780 ₺	2.135 ₺	57.605 ₺	
ES80-26 07504		10	7,5			21,5	21	20	18,5	16,5	14		36.780 ₺	2.135 ₺	61.650 ₺
ES80-26 11004		15	11			24,5	24	23,5	22	20,5	18,5		36.780 ₺	2.425 ₺	73.330 ₺

Flanşlar hariçtir. Takım fiyatı (Flange Set): 2.645 TL / Mekanik salmastra fiyat farkı: 74 EURO

TİP TYPE	Bağlantı Giriş x Çıkış Inlet x Outlet	MOTOR			m ³ /h	Debi (Q) - Capacity						FİYAT - PRICE (TL)			
		HP	kW	V		40	60	80	100	115	130	Tek Pompa Bare Pump	Şasi & Kaplin Base & Coupling	Pompa & Mot. Akuple Pump & Mot. Coupled	
ES80-32 07504	4" x 3"	10	7,5	380/660	Hm (mSS)	23	22	20	16			39.940 ₺	2.425 ₺	65.105 ₺	
ES80-32 11004		15	11			30	29	27	25	19		39.940 ₺	2.425 ₺	76.490 ₺	
ES80-32 15004		20	15			35	34	33	31	27	21		40.025 ₺	2.770 ₺	85.385 ₺
ES80-32 18504		25	18,5			37,5	37	36	35	32	26		40.025 ₺	2.770 ₺	91.955 ₺

Flanşlar hariçtir. Takım fiyatı (Flange Set): 2.645 TL / Mekanik salmastra fiyat farkı: 74 EURO



ES80 (1500 d/d) (Yumuşak veya Mekanik Salmastralı) SALYANGOZ KAPLINLİ POMPALAR

1500 d/d

VOLUTE CASING LONG-COUPLED PUMPS (Soft Packing / Mechanical Seal)

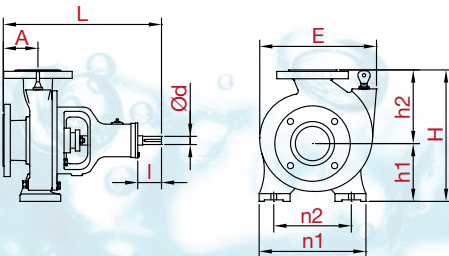
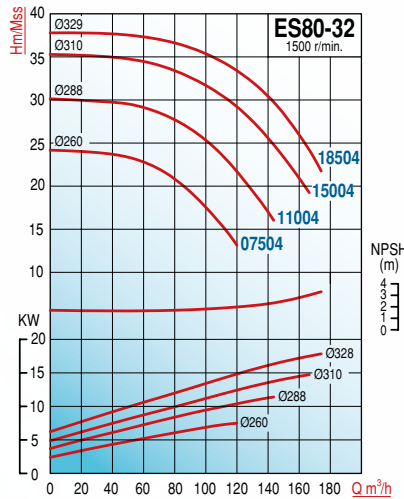
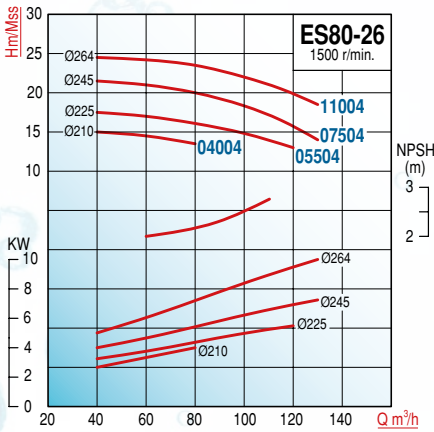
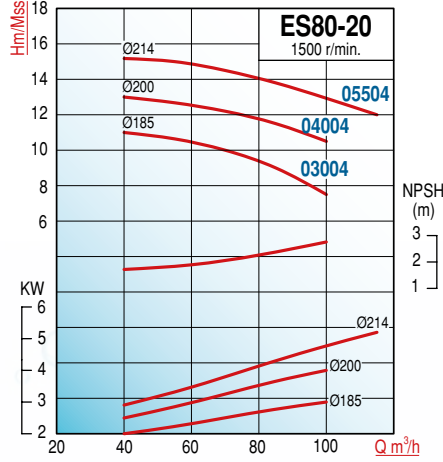
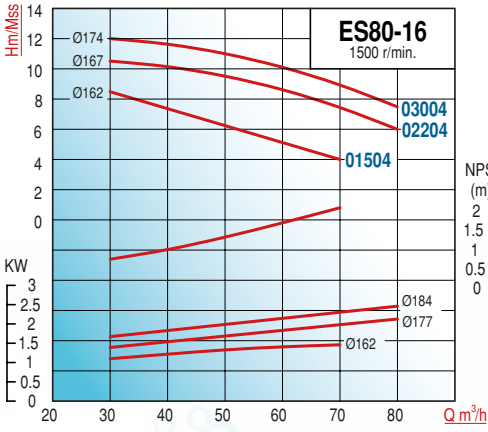

TİP TYPE	Boyutlar - Dimensions (mm)										Ağırlık - Weight
	A	L	h1	h2	H	E	n1	n2	I	d	Kg
ES80-16	125	485	180	225	405	350	320	250	50	24	51
ES80-20	125	595	180	250	430	385	345	280	84	32	65
ES80-26	125	595	200	280	480	420	400	315	84	32	86
ES80-32	125	595	250	315	565	445	400	315	84	32	92

ES100 (1500 d/d) (Yumuşak veya Mekanik Salmastralı) SALYANGOZ KAPLINLİ POMPALAR

1500 d/d

VOLUTE CASING LONG-COUPLED PUMPS (Soft Packing / Mechanical Seal)

TİP TYPE	Bağlantı Giriş x Çıkış Inlet x Outlet	MOTOR			m ³ /h	Debi (Q) - Capacity						FİYAT - PRICE (TL)		
		HP	kW	V								Tek Pompa Bare Pump	Şasi & Kaplin Base & Coupling	Pompa & Mot. Akuple Pump & Mot. Coupled
						50	80	110	140	160	180			
ES100-20 03004	5" x 4"	4.0	3	380	Hm (mSS)	9.5	9	8	6.5			34.915 ₺	2.030 ₺	49.475 ₺
ES100-20 04004		5.5	4	380 / 660		12	11.5	10.5	8.5	7		34.915 ₺	2.030 ₺	52.535 ₺
ES100-20 05504		7.5	5.5			14	13.5	13	11.5	10	8.5	34.915 ₺	2.030 ₺	55.635 ₺
ES100-20 07504		10	7.5			16	15.5	15	13.5	12	10	34.915 ₺	2.030 ₺	59.680 ₺

Flanşlar hariçtir. Takım fiyatı (Flange Set): 3.235 TL / Mekanik salmastra fiyat farkı: 74 EURO

TİP TYPE	Bağlantı Giriş x Çıkış Inlet x Outlet	MOTOR			m ³ /h	Debi (Q) - Capacity						FİYAT - PRICE (TL)			
		HP	kW	V								Tek Pompa Bare Pump	Şasi & Kaplin Base & Coupling	Pompa & Mot. Akuple Pump & Mot. Coupled	
						75	100	125	150	175	200				
ES100-26 05504	5" x 4"	7.5	5.5	380 / 660	Hm (mSS)	15	14	12				38.760 ₺	2.135 ₺	59.585 ₺	
ES100-26 07504		10	7.5			17.5	17	16	14			38.760 ₺	2.135 ₺	63.630 ₺	
ES100-26 11004		15	11			21.5	21	20.5	19.5	18			38.760 ₺	2.425 ₺	75.310 ₺
ES100-26 15004		20	15			25	24.5	24	23	22	20		38.760 ₺	2.785 ₺	84.135 ₺

Flanşlar hariçtir. Takım fiyatı (Flange Set): 3.235 TL / Mekanik salmastra fiyat farkı: 74 EURO

TİP TYPE	Bağlantı Giriş x Çıkış Inlet x Outlet	MOTOR			m ³ /h	Debi (Q) - Capacity						FİYAT - PRICE (TL)				
		HP	kW	V								Tek Pompa Bare Pump	Şasi & Kaplin Base & Coupling	Pompa & Mot. Akuple Pump & Mot. Coupled		
						100	125	150	175	200	220					
ES100-32 11004	5"x4"	15	11	380 / 660	Hm (mSS)	23	21	18	16			41.265 ₺	2.425 ₺	77.815 ₺		
ES100-32 15004		20	15			26	25	24	22	17			41.345 ₺	2.770 ₺	86.710 ₺	
ES100-32 18504		25	18,5			32	29	28	26	24	23			41.345 ₺	2.770 ₺	93.280 ₺
ES100-32 22004		30	22			35	33	32	30	27	26			41.345 ₺	2.785 ₺	106.185 ₺
ES100-32 30004		40	30			36	35	33	32	29	27			41.430 ₺	3.365 ₺	117.630 ₺

Flanşlar hariçtir. Takım fiyatı (Flange Set): 3.235 TL / Mekanik salmastra fiyat farkı: 74 EURO



ES100 (1500 d/d) (Yumuşak veya Mekanik Salmastralı) SALYANGOZ KAPLINLİ POMPALAR

1500 d/d

VOLUTE CASING LONG-COUPLED PUMPS (Soft Packing / Mechanical Seal)

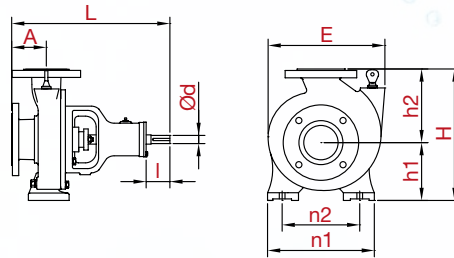
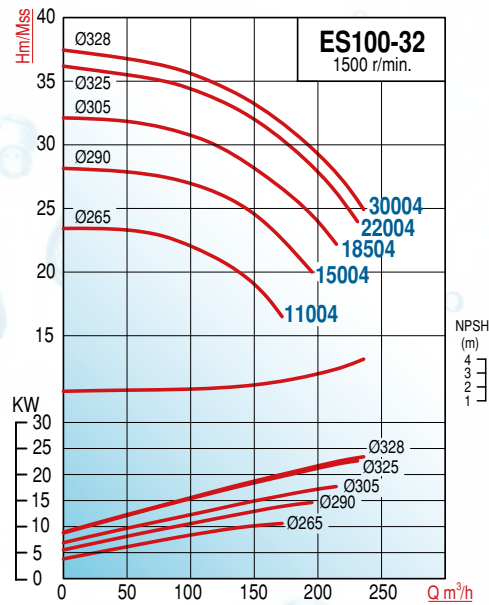
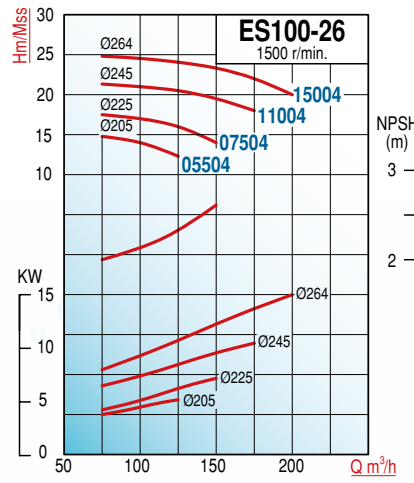
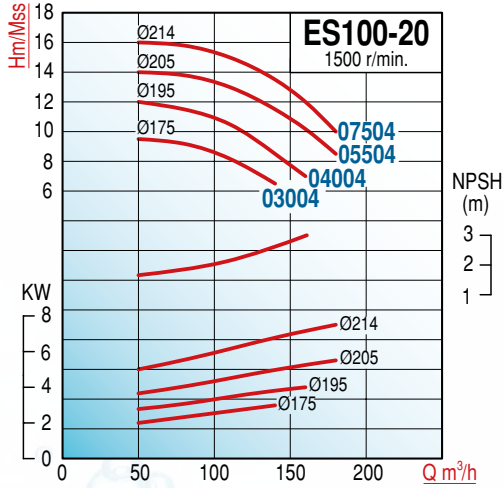

TİP TYPE	Boyutlar - Dimensions (mm)										Ağırlık - Weight
	A	L	h1	h2	H	E	n1	n2	I	d	Kg
ES100-20	125	595	200	280	480	385	360	280	84	32	75
ES100-26	140	610	225	280	505	420	400	315	84	32	96
ES100-32	140	610	250	315	565	485	400	315	84	32	100

BM

YATAY MİLLİ KADEMELİ POMPALAR

HORIZONTAL MULTISTAGE PUMPS

TİP TYPE	Bağlantı Giriş/Çıkış Inlet/Outlet	MOTOR						Kademe Stage	Debi (Q) - Capacity m ³ /h	FİYAT - PRICE (USD)						
		HP	kW	V		A				1	2	3	4	5	6	
				Mono	Tri	Mono	Tri									
BM2-9x5	1"x1"	1,5	1,1	220	-	6,2	-	5	Hm (mSS)	58	48	35	16			\$280
BM2-9x6	1"x1"	1,5	1,1	220	-	6,2	-	6		67	56	40	22			\$290
BM4-9x5	1"x1"	2	1,5	220	-	9,2	-	5		66	63	57	49	40	27	\$380
BM4-9x6	1"x1"	2	1,5	220	-	9,2	-	6		77	75	67	58	47	34	\$390

TEKNİK ÖZELLİKLERİ

- Çok kademeli
- Paslanmaz gövde (AISI 304)
- Monoblok
- Emici ve Verici gövde: PİK GG-25
- Mil: Paslanmaz çelik AISI 304
- Sızdırmazlık: Mekanik salmastra Ø16 (Karbon/Seramik/Nbr)
- Çark ve Difüzör: Noryl (PPO)
- Yataklama: Basma kısmı motor rulmanı
- Sıvı sıcaklığı: +5 °C ~ +70 °C
- Devir Hızı: 2900/dak.
- İzolasyon sınıfı: F
- Koruma sınıfı: IP54
- Emme derinliği: 6.5mt.

TECHNICAL DATA

- Multi-Stage
- Pump body: S/S (AISI 304)
- Close-coupled
- Inlet & Outlet Section: Cast iron GG-25
- Shaft: S/S (AISI 304)
- Non-Leakage: Mechanical seal Ø16 (Karbon/Seramik/Nbr)
- Impeller & Diffuser: Noryl (PPO)
- Bearing: Ball bearing on delivery side
- Liquid Temp.: +5°C ~ +60°C
- Speed: 2900 rpm.
- Insulation Class: F
- Protection Class: IP54
- Suction lift: Max 6.5 m.



KULLANIM ALANLARI

- Hidrofor sistemleri
- Apartman ve konutlar
- İş merkezleri, okul
- Endüstriyel tesisler
- Yanıcı ve Patlayıcı içermeyen temiz ve lifsiz sıvılar.
- Yağmurlama ve sprinkli sulama sistemleri

APPLICATIONS

- Booster systems
- Residences
- Business centers, Schools
- Industry
- Irrigation,
- Sprinkler systems

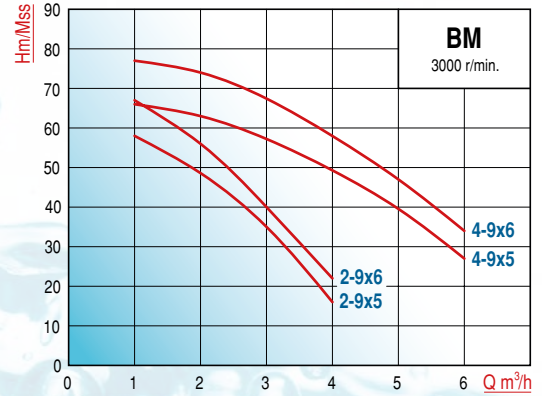

TİP TYPE	Boyutlar - Dimensions (mm)								Ağırlık - Weight Kg
	A	L	h1	h2	H	n1	n2	n3	
BM2-9x5	215	430	145	172	186	170	140	235	
BM2-9x6	237	453	145	172	186	170	140	258	
BM4-9x5	220	464	155	181	225	151	120	240	
BM4-9x6	242	485	155	181	225	151	120	243	

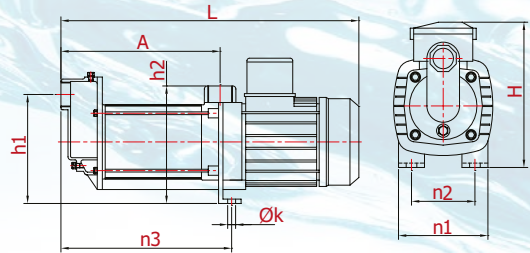

HMC DİK MİLLİ KADEMELİ POMPALAR

VERTICAL MULTISTAGE PUMPS

TİP TYPE	Bağlantı Giriş/Çıkış Inlet/Outlet	MOTOR				Kademe Stage	Debi (Q) - Capacity m ³ /h	FİYAT - PRICE (USD)														
		HP	kW	V				A		TRI												
				Mono	Tri			Mono	Tri	1	2	3	5	7	8							
HMC90-8SV	1" x 1"	2,2	1,65			380				8	Hm (mss)	93	86	77	49							\$305
HMC145-8SV	1 1/4" x 1"	3,3	2,5			380				8	Hm (mss)	103	100	96	80	52	36					\$360
HMC-10VE	1 1/4" x 1 1/4"	5	3,7			380				10	Hm (mss)	116	110	101	74	45	32					\$370



TEKNİK ÖZELLİKLERİ

- Çok kademeli
- Paslanmaz gövde (AISI 304)
- Monoblok
- Emici ve Verici gövde: PİK GG-25
- Mil: Paslanmaz çelik AISI 304
- Sızdırmazlık: Mekanik salmastra Ø16 (Karbon/Seramik/Nbr)
- Çark: AISI 304 Paslanmaz
- Difüzör: Noryl (PPO)
- Yataklama: Basma kısmı motor rulmanı
- Sıvı sıcaklığı: +5 °C ~ +60 °C
- Devir Hızı: 2900d/dak.
- İzolasyon sınıfı: F
- Koruma sınıfı: IP54
- Emme derinliği: 6.5mt.

KULLANIM ALANLARI

- Hidrofor sistemleri
- Apartman ve konutlar
- İş merkezleri, okul
- Endüstriyel tesisler
- Yanıcı ve Patlayıcı içermeyen temiz ve lifsiz sıvılar.
- Yağmurlama ve sprinkli sulama sistemleri

TECHNICAL DATA

- Multi-Stage
- Pump body: S/S (AISI 304)
- Close-coupled
- Inlet & Outlet Section: Cast iron GG-25
- Shaft: S/S (AISI 304)
- Non-Leakage: Mechanical seal Ø16 (Karbon/Seramik/Nbr)
- Impeller: S/S (AISI 304)
- Diffuser: Noryl (PPO)
- Bearing: Ball bearing on delivery side
- Liquid Temp.: +5°C ~ +60°C
- Speed: 2900 rpm.
- Insulation Class: F
- Protection Class: IP54
- Suction lift: Max 6.5 m.

APPLICATIONS

- Booster systems
- Residences
- Business centers, Schools
- Industry
- Irrigation,
- Sprinkler systems

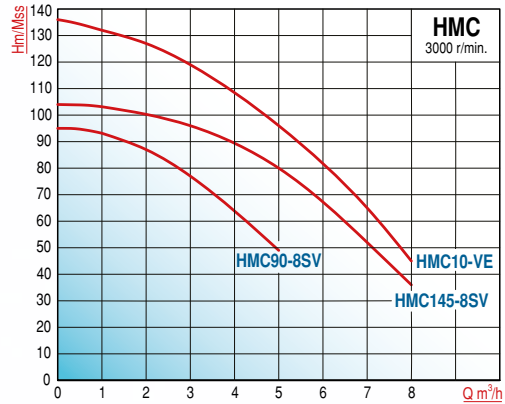

TİP TYPE	Boyutlar - Dimensions (mm)					Ağırlık - Weight Kg
	L	h1	h2	H	E	
HMC90-8SV	200	35	300	588	193	
HMC145-8SV	206	35	300	620	215	
HMC-10VE	184	35	335	735	215	

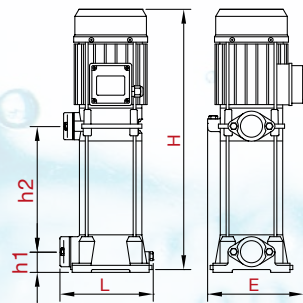

VM

DİK MİLLİ KADEMELİ POMPALAR

VERTICAL MULTISTAGE PUMPS

TİP TYPE	Bağlantı		MOTOR				Ka- deme Stage	m ³ /h	Debi (Q) - Capacity						FİYAT - PRICE (USD)		
	GirişÇıkış InletxOutlet	HP	kW	V		A			1	3	7	12	18	20	MONO	TRİ	
				Mono	Tri	Mono											Tri
VM4-9x4	1 1/4"x1"	1.5	1.1	220	380	6.2	2.4	4	53	50	40	20			\$310	\$315	
VM2-9x7	1 1/4"x1 1/4"	1.5	1.1	220	380	6.8	2.9	7	80	65	35				\$400	\$385	
VM2-9x9	1 1/4"x1 1/4"	2	1.5	220	380	9.6	3.5	9	108	87	45				\$445	\$420	
VM4-9x6	1 1/4"x1 1/4"	2	1.5	-	380	-	3.5	6	80	76	63	35			-	\$385	
VM4-9x8	1 1/4"x1 1/4"	3	2.2	-	380	-	5.3	8	99	98	82	45			-	\$435	
VM12-8.5x6	1.5"x1.5"	4	3	-	380	-	6.5	6	66	65	63	54	34	25	-	\$505	
VM12-8.5x8	1.5"x1.5"	6,3	4,7	-	380	-	9,6	8	87	85	77	66	42	30	-	\$695	
VM14-4	1.5"x1.5"	4	3	-	380	-	6,5	4	70	69	67	61	46	29	-	\$975	
VM14-5	1.5"x1.5"	5.5	4	-	380	-	8.8	5	91	90	81	69	52	34	-	\$1.075	
VM14-7	1.5"x1.5"	7.5	5.5	-	380	-	11.2	7	122	121	108	90	67	42	-	\$1.215	



TEKNİK ÖZELLİKLERİ

- Çok kademeli
- Paslanmaz gövde (AISI 304)
- Monoblok
- Emici ve Verici gövde: PİK GG-25
- Mil: Paslanmaz çelik AISI 304
- Sızdırmazlık: Mekanik salmastra (VM4-4): Ø16 (Karbon/Seramik/Viton) (VM2-7, VM2-9, VM4-6, VM4-8, VM12-6): Ø19 (Karbon/Seramik/Viton) (VM14-4, VM14-5, VM14-7): Ø20 (Karbon/Seramik/Epdm)
- Çark ve Difüzör: Noryl (PPO)
- Yataklama: Emici Gövdede bronz burç, bası tarafı motor rulmanı
- Sıvı sıcaklığı: +5 °C ~ +60 °C
- Devir Hızı: 2900d/dak.
- İzolasyon sınıfı: F
- Koruma sınıfı: IP54
- Emme derinliği: 6.5mt.

KULLANIM ALANLARI

- Hidrofor sistemleri
- Apartman ve konutlar
- İş merkezleri, okul
- Endüstriyel tesisler
- Yanıcı ve Patlayıcı içermeyen temiz ve lifsiz sıvılar.
- Yağmurlama ve sprinkli sulama sistemleri

TECHNICAL DATA

- Multi-Stage
- Pump body: S/S (AISI 304)
- Close-coupled
- Inlet & Outlet Section: Cast iron GG-25
- Shaft: S/S (AISI 304)
- Non-Leakage: Mechanical seal (VM4-4): Ø16 (Karbon/Seramik/Viton) (VM2-7, VM2-9, VM4-6, VM4-8, VM12-6): Ø19 (Karbon/Seramik/Viton) (VM14-4, VM14-5, VM14-7): Ø20 (Karbon/Seramik/Epdm)
- Impeller & Diffuser: Noryl (PPO)
- Bearing: Water lubricated bronze sleeve on suction section, ball bearing on delivery side
- Liquid Temp.: +5°C ~ +60°C
- Speed: 2900 rpm.
- Protection Class: IP54
- Insulation Class: F
- Suction lift: Max 6.5 m.

APPLICATIONS

- Booster systems
- Residences
- Business centers, Schools
- Industry
- Irrigation,
- Sprinkler systems

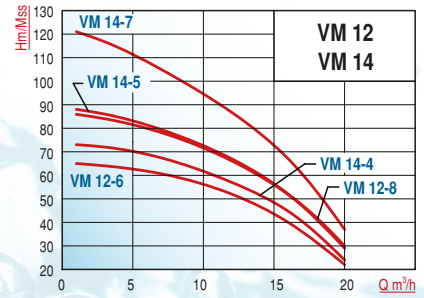
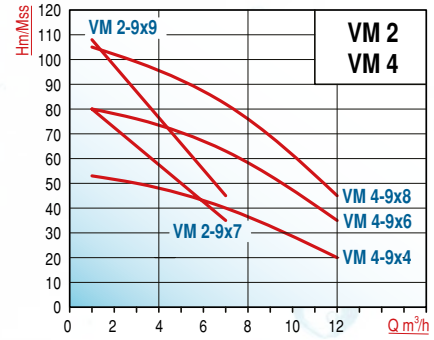

TİP TYPE	Boyutlar - Dimensions (mm)					Ağırlık - Weight Kg
	L	h1	h2	H	E	
VM4-9x4	192	44	169	430	182	18
VM2-9x7	192	44	249	538	182	19
VM2-9x9	192	44	297	586	182	24
VM4-9x6	192	44	225	514	182	20
VM4-9x8	192	44	273	562	182	23
VM12-8.5x6	192	44	311	640	182	30
VM12-8.5x8	192	44	410	760	182	33
VM14-4	315	44	220	570	195	34
VM14-5	315	44	254	601	195	36
VM14-7	315	44	314	663	195	42

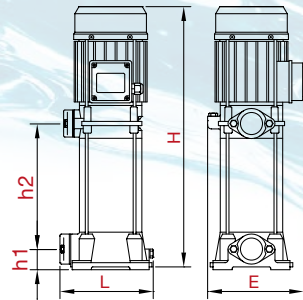

Dalgıç/Drenaj Pompalar

Submersible/Drainage Pumps



VF

DALGIÇ PİS SU (DRENAJ) POMPALARI

SUBMERSIBLE WASTE WATER (DRAINAGE) PUMPS

PARÇALAYICI YARI AÇIK ÇARKLI / SEMI OPEN CUTTER IMPELLER

TİP TYPE	Çıkış Ağızı Outlet	MOTOR				d/d	m ³ /h	Debi (Q) - Capacity								FİYAT PRICE (USD)
		HP	kW	V	A			6	12	18	21	24	30	36		
				Tri	Tri											
VF24-23	2"	3	2,2	380	4	2850	Hm (mSS)	20	19	17	17	16	13	10	\$250	
VF24-24	2"	4	3	380	6,1	2850		29	26	24	22	20	16	\$470		

*LEDLİ ELEKTRONİK PANO + FLATÖR OPSİYONELDİR. FİYAT İÇİN SAYFA 128'E BAKINIZ



TİP TYPE	Çıkış Ağızı Outlet	MOTOR				d/d	m ³ /h	Debi (Q) - Capacity								FİYAT PRICE (USD)
		HP	kW	V	A			6	18	30	42	54	72	84		
				Tri	Tri											
VF50-455	4"	5,5	4	380	8,6	2850	Hm (mSS)	21	18	17	16	15	13	11	\$540	
VF48-475	4"	7,5	5,5	380	9,6	2850		26	23	22	21	18	16	14	\$715	
VF48-310	3"	10	7,5	380	14,1	2850		39	35	32	30	27	23	16	\$725	
VF65-410	4"	10	7,5	380	14,1	2850		32	30	27	26	24	21	19	\$735	



TİP TYPE	Çıkış Ağızı Outlet	MOTOR				d/d	m ³ /h	Debi (Q) - Capacity								FİYAT PRICE (USD)
		HP	kW	V	A			0	50	75	100	120	150	180		
				Tri	Tri											
VF100-415	4"	15	11	380	18	1450		28	27	26	25	19			\$2.925	
VF100-610	6"	10	7,5	380	14,1	2850		18	15	14	10	9	2		\$1.255	
VF150-615	6"	15	11	380	23	1450						18	14	12	\$3.335	

*LEDLİ ELEKTRONİK PANO + FLATÖR OPSİYONELDİR. FİYAT İÇİN SAYFA 128'E BAKINIZ

TİP TYPE	Çıkış Ağızı Outlet	MOTOR				d/d	m ³ /h	Debi (Q) - Capacity								Fiyat Price (TL)
		HP	kW	V	A			270	280	290	300	310	320	330		
				Tri	Tri											
VF300-815	8"	15	11	380	23	1450	Hm (mSS)	9	8,5	8	7	5	4	3	\$3.290	

DALDIRMA DERİNLİĞİ (mSS): 5 mSS

*LEDLİ ELEKTRONİK PANO + FLATÖR OPSİYONELDİR. FİYAT İÇİN SAYFA 128'E BAKINIZ



VF

DALGIÇ PİS SU (DRENAJ) POMPALARI

SUBMERSIBLE WASTE WATER (DRAINAGE) PUMPS

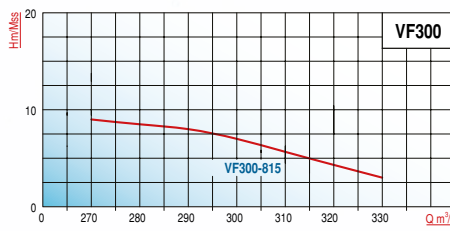
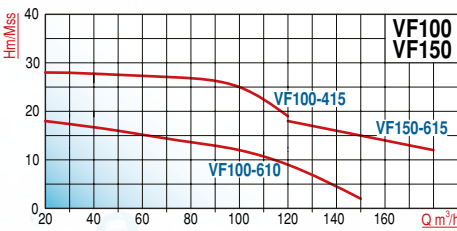
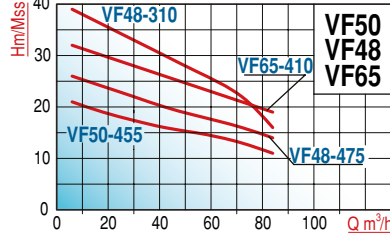
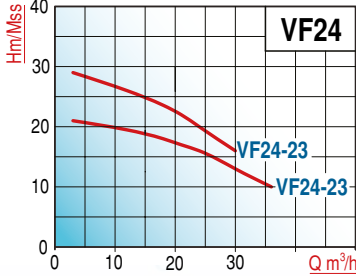

TEKNİK ÖZELLİKLER

- Çark: GG-25 PİK Döküm (VF24, VF48, VF50, VF65, VF100, VF150): Yarı Açık Çarklı (VF12, VF15, VF25): Kapalı Çarklı
- Sızdırmazlık: Yağ banyolu Silisyum Çift Mekanik Salmastra ve Yağ Keçesi. Yüzeyler: Karbon/Seramik/Silisyum/Silisyum/NBR (VF50, VF48, VF25): Ø25 VF15: Ø30 VF65, VF12, VF100(10 HP): Ø35 VF100 (15HP), VF150: Ø40
- Motor Gövdesi: GG-25 pik döküm / Pompa Gövdesi, Çark: GG-25 pik döküm
- Sıvı Sıcaklığı: +5 °C ~ +40 °C
- Devir Hızı: 2900d/dak.
- İzolasyon sınıfı: F
- Koruma sınıfı: IP68
- Frekans: 50Hz
- Suya dalma derinliği: Max: 5mt.

KULLANIM ALANLARI

- Kanalizasyon ve Çamurlu sular
- Yağmur suyu drenajı
- Evsel atık sular
- Lifli ve katı parçalı sıvılar
- Endüstriyel atıklar
- Apartments, oteller, fabrikalar
- Tarımsal Sulama
- Arıtma tesisleri

TECHNICAL DATA

- Impeller: Cast Iron GG-25 (VF24, VF48, VF50, VF65, VF100, VF150): Semi Open Impeller (VF12, VF15, VF25): Closed Impeller
- Sealing: High quality double mechanical seal running in oil bath with oil seal Surfaces: Carbon/Ceramic/Sic/Sic/NBR, (VF50, VF48, VF25): Ø25 VF15: Ø30 VF65, VF12, VF100(10 HP): Ø35 VF100 (15HP), VF150: Ø40
- Motor housing: GG-25 Iron casting / Pump Body, Impeller: GG-25 Iron casting
- Liquid Temp.: +5°C ~ +40°C
- Speed: 2900 rpm.
- Insulation Class: F
- Protection Class: IP68
- Frequency: 50Hz
- Immersion depth: Max 5 mt
- Max Solid diameter: Ø50mm.

APPLICATIONS

- Sewage and muddy water
- Rain water drainage systems
- Domestic waste waters
- Liquids containing fibrous and solid materials
- Industrial waste water
- Apartments, hotels, factories
- Irrigation
- Water treatment systems

TİP TYPE	Boyutlar - Dimensions (mm)			Ağırlık
	Boy-L Length	Yük-H Height	En-W Width	Weight Kg.
VF20-33	385	520	260	46
VF20-34	385	520	260	48
VF24-23				28
VF24-24				56
VF50-455	430	665	260	72
VF48-475	415	720	265	83
VF65-410	480	845	350	120
VF100-610	540	835	345	144
VF100-415	730	930	460	216
VF150-615	840	970	460	252
VF300-815				275
VF15-275	380	660	260	74
VF25-275	340	655	250	78
VF12-210	480	845	350	110

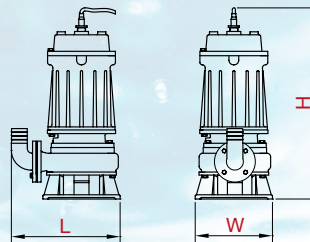

DRENAJ POMPALARI (Temiz ve Az Kirli Sular)

DRAINAGE PUMPS (Clean & Slightly Dirty Water)

TİP TYPE	ÇIKIŞ AĞIZI OUTLET	MOTOR				m ³ /h	DEBİ - CAPACITY (Q)						FİYAT-PRICE (USD)		ÖZELLİK
		HP	kW	V	A		1	2	4	6	8	9	PANOSUZ	PANOLU	
QDP-750AW	1"/1.5"	1	0,75	220	3,5	Hm(mSS)	9	8	7	6	4	3	\$95	\$188	PİS SU DRENAJI, GÖVDE&ÇARK: PLASTİK, Şamandıralı , 6 mt. Kablo ve Fişli
QDS-750DW (Paslanmaz)	1"/1.5"	1	0,75	220	4,8		10	9	8	7	6	5	\$145	\$238	PİS SU DRENAJI, GÖVDE: PASLANMAZ ÇELİK, ÇARK: Çelik, Şamandıralı, 6 mt. Kablo ve Fişli



QDP



QDS



QDS

TİP TYPE	ÇIKIŞ AĞIZI OUTLET	MOTOR				m ³ /h	DEBİ - CAPACITY (Q)						FİYAT-PRICE (USD)		ÖZELLİK
		HP	kW	V	A		1	2	3,5	4,5	6,3	8,1	PANOSUZ	PANOLU	
QDS-750A	1 1/4"	1	0,75	220	4,8	Hm (mSS)	9	8,5	7,5	7	5,6	4	\$110	\$203	TEMİZ SUDA KULLANIMA UYGUN, SIFIR KOTTAN EMİŞ GÖVDE: AISI304, Çark: PPO, Şamandıralı

TİP TYPE	ÇIKIŞ AĞIZI OUTLET	MOTOR				m ³ /h	DEBİ - CAPACITY (Q)						FİYAT-PRICE (USD)		ÖZELLİK
		HP	kW	V	A		0	3	6	9	12	15	PANOSUZ	PANOLU	
QDX6-28/2-1.1A	2"	1,5	1,1	220	5,5	Hm(mSS)	32	31	30	25	19	8	\$245	\$338	MOTOR GÖVDESİ & MİL: AISI304 Paslanmaz Çelik, POMPA GÖVDESİ & ÇARK: PİK Döküm, Şamandıralı , 12 mt. Kablo ve Fişli
QDX6-39/3-1.5A	2"	2	1,5	220	9		39	38	35	30	22	11	\$288	\$378	
QDX6-50/4-2.2A	2"	3	2,2	220	12		50	48	43	36	26	14	\$325	\$418	



QDX

DALDIRMA DERİNLİĞİ (mSS): 8 mSS

DRENAJ POMPALARI (Pis Su)

DRAINAGE PUMPS (Dirty Water)

TİP	ÇIKIŞ AĞIZI OUTLET	MOTOR				m ³ /h	DEBİ - CAPACITY (Q)						FİYAT-PRICE (USD)		ÖZELLİK
		HP	kW	V	A		5	10	15	20	24	40	PANOSUZ	PANOLU	
WQD5-15-0.75F	2"	1	0,75	220	4,8	Hm (mSS)	15	12	8	4	-	-	\$215	\$308	PARÇALAYICI AÇIK FANLI PİS SU DRENAJI, GÖVDE&FAN: PİK DÖKÜM, ÇİFT TARAFLI MEKANİK SÄLMÄSTRÄ, Şamandıralı, 10 mt. Kablo ve Fişli
WQD7-15-1.1F	2"	1,5	1,1	220	5,5		17	14	11	5	3		\$270	\$363	



WQD5



WQD7

DALDIRMA DERİNLİĞİ (mSS): 5 mSS

TİP TYPE	Boyutlar - Dimensions (mm)			Ağırlık Weight Kg.
	Boy-L	Yük-H	En-W	
	Length	Height	Width	
QDP-550A	240	35	160	4,5
QDS-750DW	290	370	160	6
QDX8-22-1.1A	250	490	200	21
QDS-750A	150	355	150	5,5
QDX6-28/2-1.1A				22
QDX6-39/3-1.5A				27
QDX6-50/4-2.2A				35
QDX6-32-1.5A	250	520	200	24
WQD5-15-0.75F	245	450	200	20
WQD7-15-1.1F	300	520	190	27

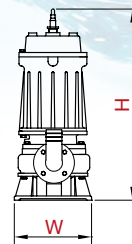
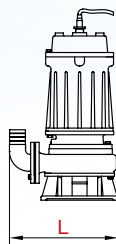

DİK BIÇAKLI DRENAJ POMPALARI (PİS SU)

CUTTING SYSTEM DRAINAGE PUMPS (Dirty water)

CUT SERİSİ

TİP TYPE	ÇIKIŞ AĞIZI OUTLET	MOTOR				m ³ /h	DEBİ - CAPACITY (Q)						FİYAT-PRICE (USD)		ÖZELLİK
		HP	kW	V	A		3	6	9	12	15	18	PANOSUZ	PANOLU	
CUT800	2"	1,1	0,8	220	6,5	14	12	11	9	6	3	\$310	\$403	DİK BIÇAKLI AÇIK FANLI PİS SU DRENAJI, GÖVDE & FAN: PIK DÖKÜM, ÇİFT TARAFLI MEKANİK SALMASTRA, Şamandıralı, 10 mt. Kablo ve Fişli	
CUT1100	2"	1,5	1,1	220	9	18	16	14	11	8	5	\$325	\$418		
CUT1500	2"	2	1,5	220	12	21	19	16	14	11	7	\$350	\$443		

DALDIRMA DERİNLİĞİ (mSS): 5 mSS
Max. Partikül Çapı: Ø 5 mm



TİP TYPE	Boyutlar - Dimensions (mm)			Ağırlık Weight Kg.
	Boy-L	Yük-H	En-W	
	Length	Height	Width	
CUT800	310	640	230	28,5
CUT1100	310	640	230	31
CUT1500	310	670	230	34

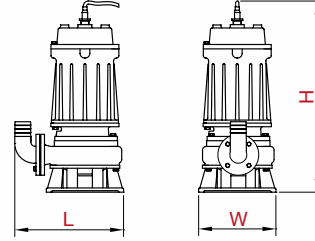

WQK SERİSİ

TİP TYPE	ÇIKIŞ AĞIZI OUTLET	MOTOR				m ³ /h	DEBİ - CAPACITY (Q)						FİYAT-PRICE (USD)	ÖZELLİK
		HP	kW	V	A		9	18	27	36	45	54		
WQK15-7-1.1QG	1¼"	1,5	1,1	380	9	9	6					\$440	TRİFAZE, DİK BIÇAKLI AÇIK FANLI PİS SU DRENAJI, GÖVDE & FAN: PIK DÖKÜM, ÇİFT TARAFLI MEKANİK SALMASTRA, 10 mt. Kablo	
WQK30-7-2.2QG	2"	3	2,2	380	4	15	13	10	8			\$525		
WQK30-10-3QG	2.5"	4	3	380	6,1	18	16	14	11			\$630		
WQK40-10-4QG	3"	5,5	4	380	7,5	20	18	16	14	9		\$745		
WQK55-10-5.5QG	3"	7,5	5,5	380	11,5	27	26	23	21	18	13	\$785		

*LEDLİ ELEKTRONİK PANO + FLATÖR OPSİYONELDİR. (141 USD)

DALDIRMA DERİNLİĞİ (mSS): 5 mSS
Max. Partikül Çapı: Ø 5 mm

TİP TYPE	Boyutlar - Dimensions (mm)			Ağırlık Weight Kg.
	Boy-L	Yük-H	En-W	
	Length	Height	Width	
WQK15-7-1.1QG	220	480	250	25
WQK30-7-2.2QG	300	550	250	39
WQK30-10-3QG	320	580	270	47
WQK40-10-4QG	330	600	290	56
WQK55-10-5.5QG	340	650	300	66

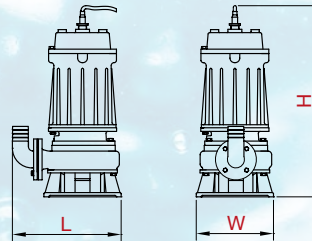

4SD

4" DALGIÇ POMPALAR

4" SUBMERSIBLE PUMPS

(Dış Çap: Ø96 mm)

TİP TYPE	MOTOR				ÇIKIŞ Outlet	m ³ /h	DEBİ(Q)-CAPACITY							BOY-L		FİYAT(USD)			
	HP	V		A			0.5	1.2	2.4	3	3.6	4.2	5	Mnf	Trf	KG	Tek Pompa	Komple (Pompa+Motor)	
		Mono	Tri	Mono										Tri	mm				
4SD 4/8	0.75	220	380	4.5	2.5	1 1/4"	H(m)	60	56	50	44	36	29	14	810	795	12	\$130	\$310
4SD 4/10	1	220	380	5.4	2.5			75	70	63	55	46	41	20	930	910	14	\$135	\$335
4SD 4/14	1.5	220	380	7.5	3.4			105	98	87	77	63	48	25	1050	1010	16	\$150	\$365
4SD 4/18	2	220	380	11.5	4.4			135	126	112	99	81	60	32	1250	1200	19	\$175	\$415
4SD 4/24	3	220	380	15	6			180	168	149	134	108	80	43	1500	1425	24	\$230	\$530
4SD 4/30	4	-	380	-	8.2			225	210	186	167	135	117	52	-	1690	25	\$305	\$680
4SD 4/40	5.5	-	380	-	10			300	277	246	222	198	170	68	-	2120	38	\$350	\$840

4SD SERİSİ TEKNİK ÖZELLİKLERİ

- Motor ve Pompa Kılıfı: AISI 304 Paslanmaz Çelik
- Çıkış Gövdesi: AISI 304 Paslanmaz Çelik (çekvalf donanımlı)
- Emiş Gövdesi: AISI 304 Paslanmaz Çelik
- Mil: AISI 304 Paslanmaz Çelik
- Çarklar: POM (Delrin)
- Difüzörler: PC (Lexan)
- Max. İzin verilebilir kum 25 gr./m³
- Mekanik keçe: Karbon-SiC/TC
- Süzgeç: AISI 304 Paslanmaz Çelik
- Kaplin: AISI 316 Paslanmaz Çelik
- SIVI SICAKLIĞI: +5 °C ~ +40°C
- Suya dalma derinliği: Max: 40 mt.
- Yağ soğutmalı motor
- İzolasyon sınıfı: B
- Koruma sınıfı: IP68
- Frekans: 50Hz
- Yol verme sayısı saatte: Max 20

TECHNICAL DATA

- Motor and Pump Tube: S/S (AISI 304)
- Outlet section: S/S (AISI 304) (built in check valve)
- Suction section: Stainless steel Pump
- Shaft: AISI 304 stainless steel
- Motor shaft gear: AISI 316 stainless steel
- Impellers: POM (Delrin)
- Diffuser: PC(Lexan)
- Max. Sand amount 25 gr./m³
- Mechanical seal:(Carbon-SiC/TC)
- Strainer: AISI 304 Stainless steel
- Coupling: AISI 316 stainless steel
- Max liquid temp.: +5 °C ~ +40°C
- Immersion depth: Max 40 mt
- Oil cooling motor
- Insulation Class: B
- Protection Class: IP68
- Frequency: 50Hz
- Starts per/h: 20 times max

KULLANIM ALANLARI

- Yer altı sularının çıkartılması
- Derin kuyular
- Tarımsal sulama
- Endüstriyel tesisler
- Binalar
- Evler

APPLICATIONS

- Lifting of ground waters
- Deep wells
- Irrigation
- Industry
- Constructions
- Residences



4" DALGIÇ MOTORLAR

4" SUBMERSIBLE MOTORS

HP	kW	V	A	Hz	Devir	KOND.	ÇAP	BOY	KG	FİYAT PRICE (USD)
					d/d rpm	µF	mm	mm		
0.75	0.55	220	4.5	50	2900	25	96	360	9	\$180
1	0.75		5.4			401		13	\$200	
1.5	1.1		7.5			416		14	\$215	
2	1.5		11.5			416		14	\$255	
3	2.2		15.0			456		16	\$300	
1	0.75	380	2.5		2900	-	96	401	13	\$200
1.5	1.1		3.4			416		14	\$215	
2	1.5		4.4			416		14	\$240	
3	2.2		6.0			456		16	\$300	
4	3		8.2			496		17	\$375	
5.5	4		10.0			576		21	\$490	
7.5	5.5		14.0			676		26	\$605	
10	7.5		18.0			776		31	\$720	



Hidroforlar Booster Systems

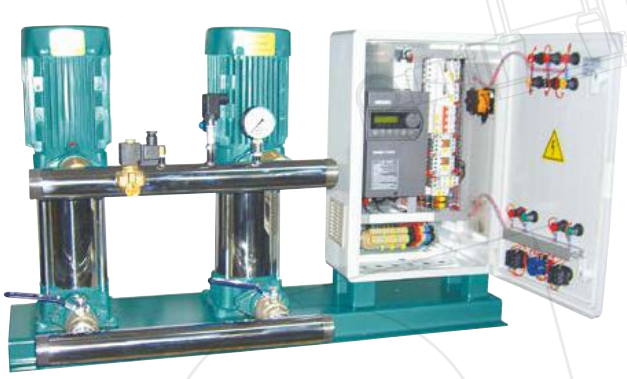

PAKET HİDROFORLAR

PACKAGED BOOSTER SETS

MINİ HİDROFORLAR (Sürtme Çarklı-Preferikal Pompalı)

BOOSTER SETS WITH PERIPHERAL PUMPS

TİP TYPE	KAT	DAİRE	POMPA TİPİ	HP	GİRİŞ ÇIKIŞ AĞZI	TANK LT.	İRTİFA	DEBİ	FİYAT (USD)	
							HM	m ³ /H	Mono 220 V	Tri 380 V
QB-60 MİNİ HİD. / 24	3	1	QB 60	½	1" x 1"	24	20-30	1.5 - 1	\$135	\$230
QB-80 HİD. / 24	5	3	QB 80	1			35-50	2.5 - 1.5	\$165	\$275

*LEDLİ ELEKTRONİK PANO + FLATÖR OPSİYONELDİR. (161 USD)

Not: Tank çalışma basıncı: Azami 8 bar



JET POMPALI HİDROFORLAR

BOOSTER SETS WITH JET PUMPS

TİP TYPE	KAT	DAİRE	POMPA TİPİ	HP	GİRİŞ ÇIKIŞ AĞZI	TANK LT.	İRTİFA	DEBİ	FİYAT	
							HM	m ³ /H	Mono 220 V	Tri 380 V
JET60B HİD./24	4	6	JET 60B	0,5	1" x 1"	24	25-35	1,5 - 2	\$190	-
JET 100 B HİD./24*	7	6	JET 100 B	1			25-40	3 - 2	\$205	-
SJET 100C HİD/24* (ÇELİK JET)	7	6	SJET 100A	1	1¼"-1"	50	25-40	3 - 2	\$310	-
JET 180 HİD. / 24*	9	10	JET 180 A	1,5			35-50	4 - 3	\$295	-
JET 180 HİD. / 50*	9	12	JET 180 A	1,5			35-50	4 - 3	\$515	-

*LEDLİ ELEKTRONİK PANO + FLATÖR OPSİYONELDİR. (161 USD)



HİDROKİTLİ HİDROFORLAR

BOOSTER SETS WITH ELECTRONIC PRESSURE CONTROLLER

TİP TYPE	KAT	DAİRE	POMPA TİPİ	HP	GİRİŞ ÇIKIŞ AĞZI	HİDRO KİT	İRTİFA	DEBİ	FİYAT (USD)	
							HM	m ³ /H	Mono 220 V	Tri 380 V
QB-60 /HİDRO KİT.	3	1	QB 60	½	1" x 1"	PC - 13A	20-30	1.5 - 1	\$130	-
QB-80 /HİDRO KİT.	5	3	QB 80	1			35-50	2.5 - 1.5	\$165	-
SJET 100C /HİDRO KİT (ÇELİK JET)	5	6	SJET 100A	1	1" x 1"	PC - 13A	25-40	3 - 2	\$215	-
JET 100 B /HİDRO KİT	5	6	JET 100 B	1			25-40	3 - 2	\$200	-

TİP TYPE	Boyutlar - Dimensions (mm)			Ağırlık
	Boy-L	Yük-H	En-W	Weight
	Length	Height	Width	Kg.
QB-60 HİD. / 24	540	590	330	12
QB-80 HİD. / 24	540	620	320	16
JET60B HİD./24	550	620	320	19,5
JET 100 B HİD./24*	540	620	320	21,5
SJET 100C HİD/24* (ÇELİK JET)	620	690	360	20
JET 180 HİD. / 24*	580	660	330	31,5
JET 180 HİD. / 50*	670	670	370	34

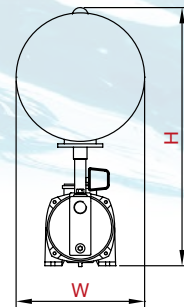
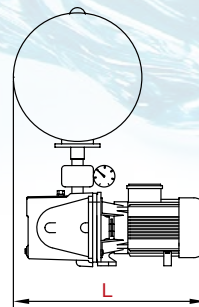

2 KADEMELİ POMPALI HİDROFORLAR

BOOSTER SETS WITH DOUBLE STAGE PUMPS

TİP TYPE	KAT	DAİRE	POMPA TİPİ	HP	GİRİŞ ÇIKIŞ AĞZI	TANK LT.	İRTİFA	DEBİ	FİYAT (TL)	
							HM	m ³ /H	Mono 220 V	Tri 380 V
KS-115 HİD. / 24*	6	6	KS-115	1,5	1" - 1"	24	30 - 40	5 - 2		24.640 ₺
KS-12 HİD. / 24*	6	8	KS-12	2	1" - 1"		30 - 40	6 - 2		25.660 ₺
KS-142 HİD. / 24*	6	10	KS-142	2	1¼" - 1"		30 - 40	7 - 3		26.470 ₺
KS-143 HİD. / 24*	7	12	KS-143	3	1¼" - 1"		35 - 45	8 - 4		29.140 ₺
KS-115 HİD. / 50*	6	8	KS-115	1,5	1" - 1"	50	30 - 40	5 - 2		28.210 ₺
KS-12 HİD. / 50*	6	10	KS-12	2	1" - 1"		30 - 40	6 - 2		29.230 ₺
KS-142 HİD. / 50*	6	12	KS-142	2	1¼" - 1"		30 - 40	7 - 3		30.040 ₺
KS-143 HİD. / 50*	7	12	KS-143	3	1¼" - 1"		35 - 45	8 - 4		32.705 ₺
KS-142 HİD. / 80*	6	12	KS-142	2	1¼" - 1"	80	30 - 40	7 - 3		31.990 ₺
KS-143 HİD. / 80*	7	14	KS-143	3	1¼" - 1"		35 - 45	8 - 4		34.660 ₺
KS-143 HİD. / 100*	7	14	KS-143	3	1¼" - 1"	100	35-45	8 - 4		35.170 ₺
KS-155 HİD. / 100*	8	25	KS-155	5,5	1.5" - 1¼"		40 - 55	15 - 4		41.385 ₺

TİP TYPE	KAT	DAİRE	POMPA TİPİ	HP	GİRİŞ ÇIKIŞ AĞZI	TANK LT.	İRTİFA	DEBİ	FİYAT (USD)	
							HM	m ³ /H	Mono 220 V	Tri 380 V
2HCP25/140 HİD. / 24*	6	6	2TCP25/140	1,5	1¼" - 1"	24	30 - 40	5 - 2	\$330	-
2HCP-160B HİD./24*	6	10	2HCP-160B	2	1.5" - 1"		30-40	7 - 3	\$375	\$370
2HCP-160B HİD. / 50*	6	12	2HCP-160B	2	1.5" - 1"	50	30-40	7 - 3	\$595	\$590
2HCP-160B HİD. / 80*	6	12	2HCP-160B	2	1.5" - 1"	80	30-40	7 - 3	\$660	\$655
2HCP-180 HİD./80*	7	14	2HCP-180	3	1.5" - 1¼"		35-45	8 - 4	\$745	\$730
2HCP-180 HİD. / 100*	7	14	2HCP-180	3	1.5" - 1¼"	100	35-45	8 - 4	\$760	\$750
2HCP-200 HİD. / 100*	8	25	2HCP-200	4	1.5" - 1¼"		40-55	15 - 4	-	\$795

*LEDLİ ELEKTRONİK PANO + FLATÖR OPSİYONELDİR. (161 USD)

Not: Tank çalışma basıncı: Azami 8 bar



TİP TYPE	Boyutlar - Dimensions (mm)			Ağırlık Weight Kg.
	Boy-L	Yük-H	En-W	
	Length	Height	Width	
2HCP25/140 HİD. / 24*	540	690	360	27
KS-115 HİD. / 24*	540	690	360	32
KS-12 HİD. / 24*	550	750	360	34
KS-142 HİD. / 24*	550	750	360	40
KS-143 HİD. / 24*	500	750	360	40
2TCP25/160 HİD. / 50*	640	740	370	39
KS-115 HİD. / 50*	640	710	370	38
KS-12 HİD. / 50*	640	710	370	40
KS-142 HİD. / 50*	640	710	370	44
KS-143 HİD. / 50*	640	710	370	44
2TCP25/160 HİD. / 80*	870	820	460	46
KS-142 HİD. / 80*	870	790	460	50
KS-143 HİD. / 80*	870	790	460	50
KS-143 HİD./100*	940	900	460	52
KS-155 HİD. / 100*	940	900	460	58

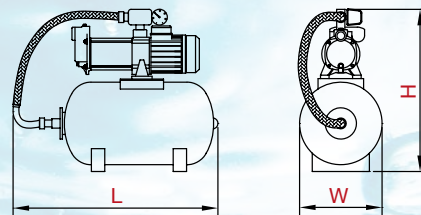

YATAY KADEMELİ POMPALI HİDROFORLAR

BOOSTER SETS WITH MULTI-STAGE PUMPS

TİP TYPE	KAT	DAİRE	POMPA TİPİ	HP	GİRİŞ ÇIKIŞ AĞZI	TANK LT.	İRTİFA	DEBİ	FİYAT PRICE (USD)
							HM	m ³ /H	
BM2-9x5 HİD./50	7	20	BM2-9x5	1,5	1" - 1"	50	16 - 58	1 - 4	\$555
BM2-9x6 HİD./50	8	20	BM2-9x6	1,5	1" - 1"		22 - 67	1 - 4	\$565
BM4-9x5 HİD./50	8	30	BM4-9x5	2	1" - 1"		27 - 66	1 - 6	\$650
BM4-9x6 HİD./50	11	30	BM4-9x6	2	1" - 1"		34 - 77	1 - 6	\$665
BM2-9x5 HİD./80	7	20	BM2-9x5	1,5	1" - 1"	80	16 - 58	1 - 4	\$650
BM2-9x6 HİD./80	8	20	BM2-9x6	1,5	1" - 1"		22 - 67	1 - 4	\$660
BM4-9x5 HİD./80	8	30	BM4-9x5	2	1" - 1"		27 - 66	1 - 6	\$720
BM4-9x6 HİD./80	11	30	BM4-9x6	2	1" - 1"		34 - 77	1 - 6	\$735
BM4-9x5 HİD./100	8	30	BM4-9x5	2	1" - 1"	100	27 - 66	1 - 6	\$760
BM4-9x6 HİD./100	11	30	BM4-9x6	2	1" - 1"		34 - 77	1 - 6	\$770

*LEDLİ ELEKTRONİK PANO + FLATÖR OPSİYONELDİR. (161 USD)

Not: Tank çalışma basıncı: Azami 10 bar

TİP TYPE	Boyutlar - Dimensions (mm)			Ağırlık
	Boy-L	Yük-H	En-W	Weight
	Length	Height	Width	Kg.
BM2-9x5 HİD./50				
BM2-9x6 HİD./50	640	72	350	24
BM4-9x5 HİD./50				31
BM4-9x6 HİD./50				31
BM2-9x5 HİD./80				29
BM2-9x6 HİD./80				29
BM4-9x5 HİD./80				36
BM4-9x6 HİD./80	740	880	410	36
BM4-9x5 HİD./100				37
BM4-9x6 HİD./100				37

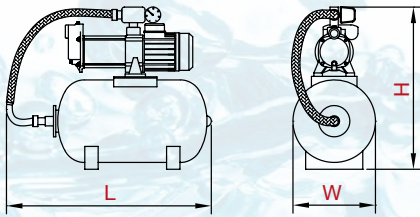

YATAY KADEMELİ ÇELİK (AISI 304) POMPALI HİDROFORLAR

BOOSTER SETS WITH MULTI-STAGE S/S (AISI 304) PUMPS

TİP TYPE	KAT	DAİRE	POMPA TİPİ	HP	GİRİŞ ÇIKIŞ AĞZI	TANK LT.	İRTİFA	DEBİ	FİYAT-PRICE (USD)	
							HM	m ³ /H	220V	380V
CMI4-5 HİD./50	7	16	CMI4-5	1	1¼" - 1"	50	23 - 46	6 - 2	\$590	\$550
CMI4-7 HİD./50	9	16	CMI4-7T	2	1¼" - 1"		38 - 64	6 - 2	\$670	\$690
CMI8-30 HİD./50	6	32	CMI8-30T	2,5	1,5" - 1,5"		32 - 54	8 - 4	\$915	\$840
CMI8-40 HİD./50	10	32	CMI8-40T	3	1,5" - 1,5"		43 - 67	8 - 4	-	\$870
CMI8-30 HİD./80	6	32	CMI8-30T	2,5	1,5" - 1,5"	80	32 - 54	8 - 4	\$980	\$905
CMI8-40 HİD./80	10	32	CMI8-40T	3	1,5" - 1,5"		43 - 67	8 - 4	-	\$935
CMI10-5 HİD./80	13	40	CMI10-5T	4	1,5" - 1,5"	100	63 - 76	10 - 4	-	\$1.030
CMI8-30 HİD./100	6	32	CMI8-30T	2,5	1,5" - 1,5"		32 - 54	8 - 4	\$1.000	\$920
CMI8-40 HİD./100	10	32	CMI8-40T	3	1,5" - 1,5"		43 - 67	8 - 4	-	\$955
CMI10-5 HİD./100	13	40	CMI10-5T	4	1,5" - 1,5"	63 - 76	10 - 4	-	\$1.045	

*LEDLİ ELEKTRONİK PANO + FLATÖR OPSİYONELDİR. (161 USD)

Not: Tank çalışma basıncı: Azami 10 bar

TİP TYPE	Boyutlar - Dimensions (mm)			Ağırlık Weight Kg.
	Boy-L Length	Yük-H Height	En-W Width	
	CMI4-7 HİD./50			
CMI8-30 HİD./50				
CMI8-40 HİD./50				
CMI8-30 HİD./80				
CMI8-40 HİD./80				
CMI10-5 HİD./80				
CMI8-30 HİD./100				
CMI8-40 HİD./100				
CMI10-5 HİD./100				

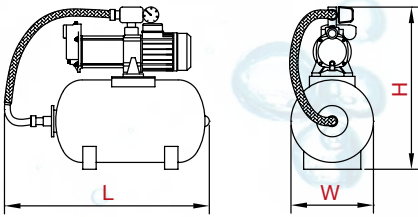

HMC

PAKET HİDROFORLAR (Tank ve Bağlantı Hortumu Hariçtir)

PACKAGED BOOSTER SETS (Excluding pressure tank and flexible hose)

BİR POMPALI HİDROFORLAR / SINGLE-PUMP BOOSTER SETS

TİP TYPE	MOTOR HP	POMPA MODELİ	KADEME STAGE	KOLLEKTÖR Çıkış Outlet	m ³ /h	DEBİ (Q) - CAPACITY						FİYAT (USD)		
						1	2	3	5	7	8	Tri	380 V	
HMC90x1 HİD.	2,2	HMC90-8SV	8	1" x 1"	m ³ (mSS)	93	86	77	49					\$970
HMC145x1 HİD.	3,3	HMC145-8SV	8	1 1/4" x 1"	m ³ (mSS)	103	100	96	80	52	36			\$1.035
HMC10x1 HİD.	5	HMC10-VE	10	1 1/4" x 1 1/4"	Hm	132	128	118	96	65	45			\$1.050
TAM KORUMALI ELEKTRONİK LCD EKRANLI PANO FARKI: Mavi LCD Ekran, 0,37 - 7,5 kW arası kullanım imkanı, Moment kontrol ile Susuz çalışmaya karşı Flatör ve SSR kulanmadan koruma, Fazlar arası gerilim gösterimi, Akım değerleri gösterimi, Gerilim koruma (Alt - Üst Gerilim değerleri ayarlama), Akım değerleri ayarlama, Otomatik / Manuel çalışma seçimi, Pompa çalışma zamanını ekranda görebilme, Arıza durumunda kendini otomatik resetleme, son 20 arıza bilgisi, Arıza durumunda sesli buzzer ve Röle kontağı ile bildirme. Otomatik Sulama özelliği Türkçe ve İngilizce Dil seçeneği.												\$35		



İKİ POMPALI HİDROFORLAR / TWO-PUMP BOOSTER SETS

TİP TYPE	MOTOR HP	POMPA MODELİ	KADEME STAGE	KOLLEKTÖR GirişÇıkış InletxOutlet	m ³ /h	DEBİ (Q) - CAPACITY						FİYAT (USD)		
						2	4	6	10	14	16	Tri	380 V	
HMC90x2 HİD.	2,2	HMC90-8SV	8	1 1/2" X 1 1/4"	m ³ (mSS)	93	86	77	49					\$1.690
HMC145x2 HİD.	3,3	HMC145-8SV	8		m ³ (mSS)	103	100	96	80	52	36			\$1.825
HMC10x2 HİD.	5	HMC10-VE	10		Hm	132	128	118	96	65	45			\$1.850
TAM KORUMALI ELEKTRONİK LCD EKRANLI PANO FARKI: Mavi LCD Ekran, 0,37 - 7,5 kW arası kullanım imkanı, Moment kontrol ile Susuz çalışmaya karşı Flatör ve SSR kulanmadan koruma, Fazlar arası gerilim gösterimi, Akım değerleri gösterimi, Gerilim koruma (Alt - Üst Gerilim değerleri ayarlama), Akım değerleri ayarlama, Otomatik / Manuel çalışma seçimi, Pompa çalışma zamanını ekranda görebilme, Arıza durumunda kendini otomatik resetleme, son 20 arıza bilgisi, Arıza durumunda sesli buzzer ve Röle kontağı ile bildirme. Otomatik Sulama özelliği Türkçe ve İngilizce Dil seçeneği.												\$80		



ÜÇ POMPALI HİDROFORLAR / THREE-PUMP BOOSTER SETS

TİP TYPE	MOTOR HP	POMPA MODELİ	KADEME STAGE	KOLLEKTÖR GirişÇıkış InletxOutlet	m ³ /h	DEBİ (Q) - CAPACITY						FİYAT (USD)		
						3	6	9	15	21	24	Tri	380 V	
HMC90x3 HİD.	2,2	HMC90-8SV	8	2" X 2"	m ³ (mSS)	93	86	77	49					\$2.395
HMC145x3 HİD.	3,3	HMC145-8SV	8		m ³ (mSS)	103	100	96	80	52	36			\$2.595
HMC10x3 HİD.	5	HMC10-VE	10		Hm	132	128	118	96	65	45			\$2.710
TAM KORUMALI ELEKTRONİK LCD EKRANLI PANO FARKI: Mavi LCD Ekran, 0,37 - 7,5 kW arası kullanım imkanı, Moment kontrol ile Susuz çalışmaya karşı Flatör ve SSR kulanmadan koruma, Fazlar arası gerilim gösterimi, Akım değerleri gösterimi, Gerilim koruma (Alt - Üst Gerilim değerleri ayarlama), Akım değerleri ayarlama, Otomatik / Manuel çalışma seçimi, Pompa çalışma zamanını ekranda görebilme, Arıza durumunda kendini otomatik resetleme, son 20 arıza bilgisi, Arıza durumunda sesli buzzer ve Röle kontağı ile bildirme. Otomatik Sulama özelliği Türkçe ve İngilizce Dil seçeneği.												\$55		



TEKNİK ÖZELLİKLER

Pompa:

- Pompa Gövdesi: GG-22 Pik
- Kademe Gömleği: AISI 304 Çelik
- Çark: AISI304 Paslanmaz çelik
- Pompa Mili: AISI 304 Çelik
- Mekanik Salmastra sızdırmazlık (Karbon/Seramik/NBR)
- Çok Sesiz çalışma, düşük sarfiyat.
- Sıvı sıcaklığı: +5 °C ~ +60 °C
- Çek-Valf ve Vana donanımı
- Şase: Çelik Sac (Titreşim önleyici kauçuk ayaklı)
- Susuz Çalışma Önleyici Seviye Flatörü
- Emiş ve Basış Kollektörleri dahil.
- Monometre ve Basınç Şalterli.
- Çek-Valf: Yaylı, sessiz
- Vana: Küresel (Bir Pompalı Hidroforlarda opsiyonel)

Pano:

- Faz Gerilim Koruma (Alt - Üst Değer Girebilme)
- Motor Akım Koruma (Alt - Üst Değer Girebilme)
- Çalışma Mod Seçimi
- Uyarı Ledleri
- Otomatik Resetleme

Opsiyonel Tam Korumalı Pano:

- Motor Tanıma Modu
- Cihazda Oluşan Son 20 Arıza Kaydı
- Sulama Modu
- Nötrsüz Çalışma (Gemilerde Kullanım imkanı)

Not:

- Emiş Yapan Hidroforlarda Emiş Kollektörü Kullanılmaz. Her Pompaaya ayrı emiş borusu ve dip klapesi olmalıdır.
- Motorlarınızın sorunsuz çalışabilmesi ancak Motor Koruma Sistemli Panoların kullanımı ile mümkündür.

KULLANIM ALANLARI

- Apartmanlar, siteler
- Okul, iş ve alışveriş merkezleri
- Sosyal tesisler
- Yangın söndürme sistemleri
- Su dağıtım istasyonları

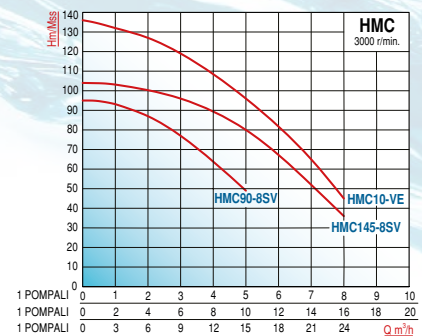

PVM

BİR POMPALI PAKET HİDROFORLAR (Tank ve Bağlantı Hortumu Hariçtir)

SINGLE-PUMP PACKAGED BOOSTER SETS (Excluding pressure tank and flexible hose)

TİP TYPE	KAT	DARİE SAYISI	MOTOR HP	POMPA MODELİ	KADEME STAGE	KOLLEKTÖR		m ³ /h	DEBİ (Q) - CAPACITY						FİYAT (USD)		
						Giriş Inlet	Çıkış Outlet		1	3	7	12	18	20	Mono		Tri
															220 V	380 V	
PVM4-4x1 HİD.	6	12	1.5	VM4-4	4	1"	1"	Hm (mss)	53	50	40	20			\$925	\$930	
PVM2-7x1 HİD.	10	12	1.5	VM2-7	7	1"	1"		80	65	35				\$1.005	\$995	
PVM2-9x1 HİD.	15	14	2	VM2-9	9	1"	1"		108	87	45				\$1.050	\$1.025	
PVM4-6x1 HİD.	10	24	2	VM4-6	6	1"	1"		80	76	63	35				\$995	
PVM4-8x1 HİD.	15	24	3	VM4-8	8	1"	1"		99	97	82	45				\$1.040	
PVM12-6x1 HİD.	8	45	4	VM12-6	6	1.5"	1.5"		66	65	60	52	40	25		\$1.140	
PVM12-8x1 HİD.	12	45	6.3	VM12-8	8	1.5"	1.5"		87	85	77	66	42	30		\$1.320	
PVM14-4x1 HİD.	11	33	4	VM14-4	4	1.5"	1.5"		70	69	67	61	46	29		\$1.585	
PVM14-5x1 HİD.	16	36	5.5	VM14-5	5	1.5"	1.5"		91	90	81	69	52	34		\$1.715	
PVM14-7x1 HİD.	22	40	7.5	VM14-7	7	1.5"	1.5"		122	121	108	90	67	42		\$1.810	
TAM KORUMALI ELEKTRONİK LCD EKРАНLI PANO FARKI: Mavi LCD Ekran, 0.37 - 7.5 kW arası kullanım imkanı, Moment kontrol ile Susuz çalışmaya karşı Flatör ve SSR kullanmadan koruma, Fazlar arası gerilim gösterimi, Akım değerleri gösterimi, Gerilim koruma (Alt - Üst Gerilim değerleri ayarlama), Akım değerleri ayarlama, Otomatik / Manuel çalışma seçimi, Pompa çalışma zamanını ekranda görebilme, Arıza durumunda kendini otomatik resetleme, son 20 arıza bilgisi, Arıza durumunda sesli buzzer ve Röle kontağı ile bildirme. Türkçe ve İngilizce Dil seçeneği.												\$35	\$35				



TEKNİK ÖZELLİKLER

Pompa:

- Pompa Gövdesi: GG-25 Pik
- Kademe Gömleği: AISI 304 Çelik
- Çark, Difüzör: Noryl (PPO)
- Pompa Mili: AISI 304 Çelik
- Mekanik Salmastra sızdırmazlık (Karbon/Seramik/NBR)
- Çok Sesiz çalışma, düşük sarfiyat.
- Sıvı sıcaklığı: +5 °C ~ +60 °C
- Çek-Valf ve Vana donanımı
- Şase: Çelik Sac (Titreşim önleyici kauçuk ayaklı)
- Susuz Çalışma Önleyici Seviye Flatörü
- Emiş ve Basış Kollektörleri dahil.
- Monometre ve Basınç Şalteri.
- Çek-Valf: Yaylı, sessiz
- Vana: Küresel (Bir Pompalı Hidroforlarda opsiyonel)

KULLANIM ALANLARI

- Apartmanlar, siteler
- Okul, iş ve alışveriş merkezleri
- Sosyal tesisler
- Yangın söndürme sistemleri
- Su dağıtım istasyonları

Pano:

- Faz Gerilim Koruma (Alt - Üst Değer Girebilme)
- Motor Akım Koruma (Alt - Üst Değer Girebilme)
- Çalışma Mod Seçimi
- Uyarı Ledleri
- Otomatik Resetleme

Opsiyonel Tam Korumalı Pano:

- Motor Tanıma Modu
- Cihazda Oluşan Son 20 Arıza Kaydı
- Sulama Modu
- Nötrüz Çalışma (Gemilerde Kullanım imkanı)

Not:

- Emiş Yapan Hidroforlarda Emiş Kollektörü Kullanılmaz. Her Pompaya ayrı emiş borusu ve dip klapesi olmalıdır.
- Motorlarınızın sorunsuz çalışabilmesi ancak Motor Koruma Sistemli Panoların kullanımı ile mümkündür.

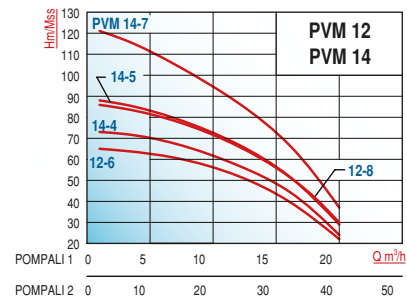
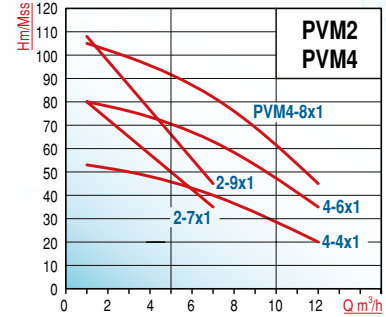

TİP TYPE	Boyutlar - Dimensions (mm)			Ağırlık Weight Kg.
	En-W	Yük-H	Boy-L	
	Width	Height	Length	
PVM2-7x1 HİD.	340	598	390	27
PVM2-9x1 HİD.	340	646	390	32
PVM4-4x1 HİD.	340	490	390	26
PVM4-6x1 HİD.	340	574	390	28
PVM4-8x1 HİD.	340	622	390	31
PVM12-6x1 HİD.	340	700	390	36
PVM12-8x1 HİD.	340	820	390	39
PVM14-4x1 HİD.	340	630	480	42
PVM14-5x1 HİD.	340	661	480	44
PVM14-7x1 HİD.	340	723	480	50

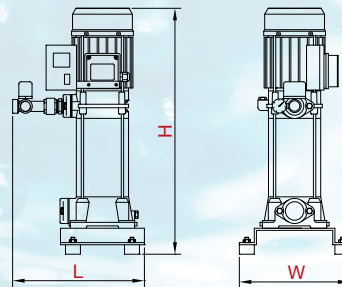

PVM

İKİ POMPALI PAKET HİDROFORLAR (Tank ve Bağlantı Hortumu Hariçtir)

TWO-PUMP PACKAGED BOOSTER SETS (Excluding pressure tank and flexible hose)

TİP TYPE	KAT	DARİE SAYISI	MOT. HP	POMPA MODELİ	KADEME STAGE	KOLLEKTÖR		m ³ /h	DEBİ (Q) - CAPACITY						FİYAT (USD)			
						Giriş Inlet	Çıkış Outlet		2	6	14	24	36	40	Mono		Tri	
															220 V	380 V		
PVM4-4x2 HİD.	6	24	1.5	VM4-4	4	2"	1½"	Hm (mss)	53	50	40	20				\$1.610	\$1.625	
PVM2-7x2 HİD.	10	24	1.5	VM2-7	7	1½"	1¼"		80	65	35						\$1.780	\$1.760
PVM2-9x2 HİD.	15	28	2	VM2-9	9	1½"	1¼"		108	87	45						\$1.870	\$1.820
PVM4-6x2 HİD.	10	48	2	VM4-6	6	2"	1½"		80	76	63	35					\$1.755	
PVM4-8x2 HİD.	15	48	3	VM4-8	8	2"	1½"		99	97	82	45					\$1.845	
PVM12-6x2 HİD.	8	90	4	VM12-6	6	2,5"	2,5"		66	65	60	52	40	25			\$2.105	
PVM12-8x2 HİD.	12	90	6,3	VM12-8	8	2,5"	2,5"		87	85	77	66	42	30			\$2.465	
PVM14-4x2 HİD.	11	66	4	VM14-4	4	2,5"	2,5"		70	69	67	61	46	29			\$2.995	
PVM14-5x2 HİD.	16	80	5.5	VM14-5	5	2,5"	2,5"		91	90	81	69	52	34			\$3.245	
PVM14-7x2 HİD.	22	80	7.5	VM14-7	7	2,5"	2,5"		122	121	108	90	67	42			\$3.445	
TAM KORUMALI ELEKTRONİK LCD EKRAKLI PANO FARKI: Mavi LCD Ekran, 0,37 - 7,5 kW arası kullanım imkanı, Moment kontrolü ile Susuz çalışmaya karşı Flatör ve SSR kullanmadan koruma, Fazlar arası gerilim gösterimi, Akım değerleri gösterimi, Gerilim koruma (Alt - Üst Gerilim değerleri ayarlama), Akım değerleri ayarlama, Otomatik / Manuel çalışma seçimi, Pompa çalışma zamanını ekranda görebilme, Arıza durumunda kendini otomatik resetleme, son 20 arıza bilgisi, Arıza durumunda sesli buzzer ve Röle kontağı ile bildirme. Türkçe ve İngilizce Dil seçeneği.												\$80	\$80					



TEKNİK ÖZELLİKLER

Pompa:

- Pompa Gövdesi: GG-25 Pisk
- Kademe Gömleği: AISI 304 Çelik
- Çark, Difüzör: Noryl (PPO)
- Pompa Mili: AISI 304 Çelik
- Mekanik Salmastra sızdırmazlık (Karbon/Seramik/NBR)
- Çok Sesiz çalışma, düşük sarfiyat.
- Sıvı sıcaklığı: +5 °C ~ +60 °C
- Çek-Valf ve Vana donanımı
- Şase: Çelik Sac (Titreşim önleyici kauçuk ayaklı)
- Susuz Çalışma Önleyici Seviye Flatörü
- Emiş ve Basış Kollektörleri dahil.
- Monometre ve Basınç Şalteri.
- Çek-Valf: Yaylı, sessiz
- Vana: Küresel (Bir Pompalı Hidroforlarda opsiyonel)

KULLANIM ALANLARI

- Apartmanlar, siteler
- Okul, iş ve alışveriş merkezleri
- Sosyal tesisler
- Yangın söndürme sistemleri
- Su dağıtım istasyonları

Pano:

- Faz Gerilim Koruma (Alt - Üst Değer Girebilme)
- Motor Akım Koruma (Alt - Üst Değer Girebilme)
- Çalışma Mod Seçimi
- Uyarı Ledleri
- Otomatik Resetleme

Opsiyonel: LCD Pano (Hassas Ayarlı):

- LCD Göstergeli Ekran
- Hassas Ayar Butonları
- Voltmetre & Ampermetre & Pompa Çalışma Süreleri, Koruma Gecikme Süreleri ve Tolerans Yüzdeleleri (Dijital Göstergeli)
- Faz Gerilim Koruma özelliği,
- Motor Koruma (Ampermetrik)
- Yüksek Akım ve Gerilime Karşı Hassas Motor Koruma,
- Düşük Akım ve Gerilime Karşı Hassas Koruma,
- Süreli ve Rotasyonlu (Sıralı) Çalıştırma Yöntemi ile Eş Yaşlandırma
- Şalt Sayısı / Saat Ayarı
- Kalkışta Yüzdesel Demeraj Tolerans Ayarı
- Akım ve Koruma Gecikme Süresi ayar özelliği
- Sistem İkaz Ledleri (Susuz - Voltaj - Faz - Çalışma-Arıza)
- Susuz çalışmaya karşı Akım Kontrollü ve Flatörlü koruma,
- Her Pompa için Otomatik - Manuel Test Butonu,
- Haftalık Programlı Kendini Test Özelliği (Opsiyonel)

Not:

- Emiş Yapan Hidroforlarda Emiş Kollektörü Kullanılmaz. Her Pompaya ayrı emiş borusu ve dip klapesi olmalıdır.
- Motorlarınızın sorunsuz çalışabilmesi ancak Motor Koruma Sistemli Panoların kullanımı ile mümkündür.

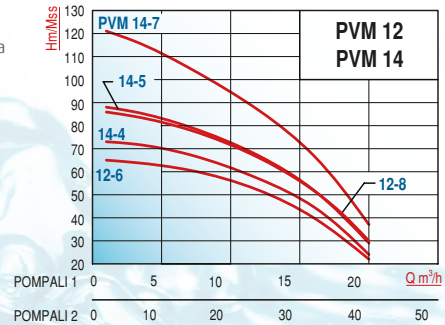
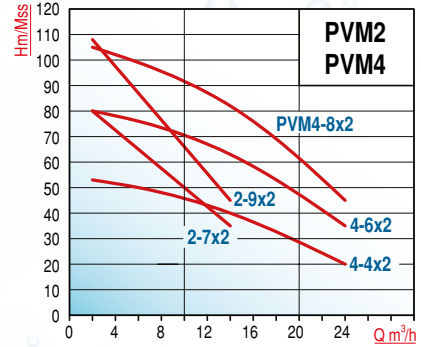

TİP TYPE	Boyutlar - Dimensions (mm)			Ağırlık Weight Kg.
	EN-W	Yük-H	Boy-L	
	Width	Height	Length	
PVM2-7x2 HİD.	610	973	440	66
PVM2-9x2 HİD.	610	1021	440	76
PVM4-4x2 HİD.	610	865	440	64
PVM4-6x2 HİD.	610	949	440	68
PVM4-8x2 HİD.	610	997	440	74
PVM12-6x2 HİD.	610	1075	440	84
PVM12-8x1 HİD.	610	1195	440	90
PVM14-4x2 HİD.	610	987	440	95
PVM14-5x2 HİD.	610	1018	440	100
PVM14-7x2 HİD.	610	1084	440	112

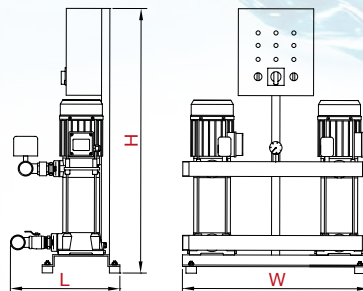

PVM

ÜÇ POMPALI PAKET HİDROFORLAR (Tank ve Bağlantı Hortumu Hariçtir)

THREE-PUMP PACKAGED BOOSTER SETS (Excluding pressure tank and flexible hose)

TİP TYPE	KAT	DARİE SAYISI	MOTOR HP	POMPA MODELİ	KADEME STAGE	KOLLEKTÖR		m ³ /h	DEBİ (Q) - CAPACITY						FİYAT (USD)	
						Giriş Inlet	Çıkış Outlet		3	9	21	36	54	60	Mono	
															220 V	380 V
PVM4-4x3 HİD.	6	36	1.5	VM14-4	4	3"	2.5"	Hm (mSS)	53	50	40	20			\$2.285	\$2.305
PVM2-7x3 HİD.	10	36	1.5	VM2-7	7	3"	2.5"		80	65	35				\$2.535	\$2.505
PVM2-9x3 HİD.	15	42	2	VM2-9	9	3"	2.5"		108	87	45				\$2.670	\$2.600
PVM4-6x3 HİD.	10	72	2	VM4-6	6	3"	2.5"		80	76	63	35				\$2.505
PVM4-8x3 HİD.	15	72	3	VM4-8	8	3"	2.5"		99	97	82	45				\$2.635
PVM12-6x3 HİD.	8	135	4	VM12-6	6	3"	3"		66	65	60	52	40	25		\$2.985
PVM12-8x3 HİD.	12	135	6.3	VM12-8	8	3"	3"		87	85	77	66	42	30		\$3.525
PVM14-4x3 HİD.	11	100	4	VM14-4	4	3"	3"		70	69	67	61	46	29		\$4.320
PVM14-5x3 HİD.	16	120	5.5	VM14-5	5	3"	3"		91	90	81	69	52	34		\$4.710
PVM14-7x3 HİD.	22	120	7.5	VM14-7	7	3"	3"		122	121	108	90	67	42		\$4.995
TAM KORUMALI ELEKTRONİK LCD EKРАНLI PANO FARKI: Mavi LCD Ekran, 0.37 - 7.5 kW arası kullanım imkanı, Moment kontrol ile Susuz çalışmaya karşı Flatör ve SSR kulanmadan koruma, Fazlar arası gerilim gösterimi, Akım değerleri gösterimi, Gerilim koruma (Alt - Üst Gerilim değerleri ayarlama), Akım değerleri ayarlama, Otomatik / Manuel çalışma seçimi, Pompa çalışma zamanını ekranda görebilme, Arıza durumunda kendini otomatik resetleme, son 20 arıza bilgisi, Arıza durumunda sesli buzzer ve Röle kontağı ile bildirme. Türkçe ve İngilizce Dil seçeneği.												\$55	\$55			

TEKNİK ÖZELLİKLER

Pompa:

- Pompa Gövdesi: GG-25 Pik
- Kademe Gömleği: AISI 304 Çelik
- Çark, Difüzör: Noryl (PPO)
- Pompa Mili: AISI 304 Çelik
- Mekanik Salmastra sızdırmazlık (Karbon/Seramik/NBR)
- Çok Sesiz çalışma, düşük sarfiyat.
- Sıvı sıcaklığı: +5 °C ~ +60 °C
- Çek-Valf ve Vana donanımı
- Şase: Çelik Sac (Titreşim önleyici kauçuk ayaklı)
- Susuz Çalışma Önleyici Seviye Flatörü
- Emiş ve Basış Kollektörleri dahil.
- Monometre ve Basınç Şalterli.
- Çek-Valf: Yaylı, sessiz
- Vana: Küresel (Bir Pompalı Hidroforlarda opsiyonel)

KULLANIM ALANLARI

- Apartmanlar, siteler
- Okul, iş ve alışveriş merkezleri
- Sosyal tesisler
- Yangın söndürme sistemleri
- Su dağıtım istasyonları

Pano:

- Faz Gerilim Koruma (Alt - Üst Değer Girebilme)
- Motor Akım Koruma (Alt - Üst Değer Girebilme)
- Çalışma Mod Seçimi
- Uyarı Ledleri
- Otomatik Resetleme

Opsiyonel: LCD Pano (Hassas Ayarlı):

- LCD Göstergeli Ekran
- Hassas Ayar Butonları
- Voltmetre & Ampermetre & Pompa Çalışma Süreleri, Koruma Gecikme Süreleri ve Tolerans Yüzdeleeri (Dijital Göstergeli)
- Faz Gerilim Koruma özelliği,
- Motor Koruma (Ampermetrik)
- Yüksek Akım ve Gerilime Karşı Hassas Motor Koruma,
- Düşük Akım ve Gerilime Karşı Hassas Koruma,
- Süreli ve Rotasyonlu (Sıralı) Çalıştırma Yöntemi ile Eş Yaşlandırma
- Şalt Sayısı / Saat Ayarı
- Kalkışta Yüzdesel Demeraj Tolerans Ayarı
- Akım ve Koruma Gecikme Süresi ayar özelliği
- Sistem İkaz Ledleri (Susuz - Voltaj - Faz - Çalışma-Arıza)
- Susuz çalışmaya karşı Akım Kontrollü ve Flatörlü koruma,
- Her Pompa için Otomatik - Manuel Test Butonu,
- Haftalık Programlı Kendini Test Özelliği (Opsiyonel)

Not:

- Emiş Yapan Hidroforlarda Emiş Kollektörü Kullanılmaz. Her Pompaya ayrı emiş borusu ve dip klapesi olmalıdır.
- Motorlarınızın sorunsuz çalışabilmesi ancak Motor Koruma Sistemli Panoların kullanımı ile mümkündür.

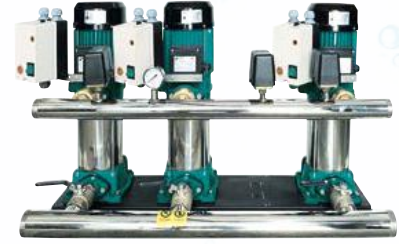

TİP TYPE	Boyutlar - Dimensions (mm)			Ağırlık Weight Kg.
	EN-W	Yük-H	Boy-L	
	Width	Height	Length	
PVM2-7x3 HİD.	905	973	440	98
PVM2-9x3 HİD.	905	1021	440	113
PVM4-4x3 HİD.	905	865	440	95
PVM4-6x3 HİD.	905	949	440	101
PVM4-8x3 HİD.	905	997	440	110
PVM12-6x3 HİD.	905	1075	440	125
PVM12-8x3 HİD.	905	1195	440	134
PVM14-4x3 HİD.	905	987	440	141
PVM14-5x3 HİD.	905	1018	440	149
PVM14-7x3 HİD.	905	1084	440	167

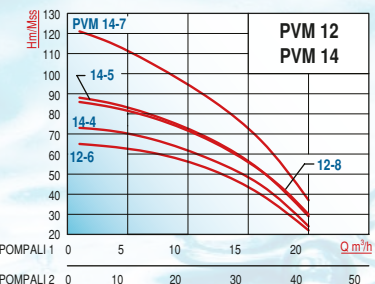
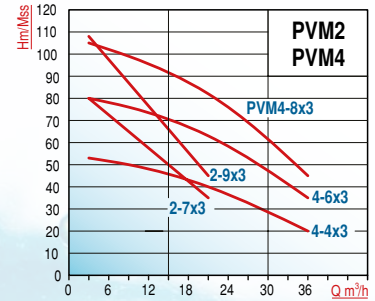
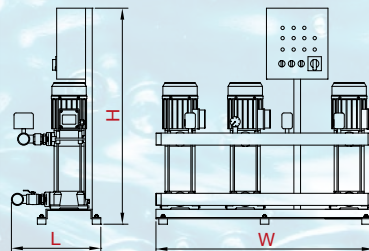

CVL

PASLANMAZ POMPALI PAKET HİDROFORLAR (Tank ve Bağlantı Hortumu Hariçtir)

PACKAGED BOOSTER SETS (Excluding pressure tank and flexible hose)

BİR POMPALI HİDROFORLAR / SINGLE-PUMP BOOSTER SETS

TİP TYPE	MOTOR		KADEME STAGE	KOLLEKTÖR		m ³ /h	DEBİ (Q) - CAPACITY						FİYAT PRICE (USD)
	HP	kW		Giriş Inlet	Çıkış Outlet		1	2	2,5	3	3,5	4	
CVL3-10x1 HİD.	1	0,75	10	1¼"	1¼"	Hm	60	55	50	43	36	28	\$1.695
CVL3-12x1 HİD.	1,5	1,1	12				72	66	59	52	44	34	\$1.725
CVL3-15x1 HİD.	1,5	1,1	15				90	82	77	69	60	44	\$1.770
CVL3-19x1 HİD.	2	1,5	19				113	104	98	88	77	58	\$1.915
CVL3-29x1 HİD.	3	2,2	29				170	156	147	132	118	93	\$2.130
CVL5-10x1 HİD.	2	1,5	10	1¼"	1¼"	Hm	2	3	4	5	6,5	8	\$1.830
CVL5-12x1 HİD.	3	2,2	12				62	59	55	50	41	30	\$1.895
CVL5-16x1 HİD.	3	2,2	16				75	73	68	62	49	36	\$1.985
CVL5-20x1 HİD.	4	3	20				103	100	94	85	69	48	\$2.165
CVL5-29x1 HİD.	5,5	4	29				129	122	115	105	86	60	\$2.485
CVL10-6x1 HİD.	3	2,2	6	1½"	1½"	Hm	2	6	8	10	12	14	\$2.075
CVL10-7x1 HİD.	4	3	7				62	58	53	46	38	28	\$2.175
CVL10-9x1 HİD.	4	3	9				73	67	61	54	43	32	\$2.270
CVL10-12x1 HİD.	5,5	4	12				93	87	81	71	59	42	\$2.480
CVL10-16x1 HİD.	7,5	5,5	16				123	117	108	95	78	55	\$2.910
CVL15-5x1 HİD.	5,5	4	5	2"	2"	Hm	8	12	15	18	20	24	\$2.340
CVL15-7x1 HİD.	7,5	5,5	7				68	61	56	50	45	33	\$2.725
CVL15-9x1 HİD.	10	7,5	9				94	88	80	71	64	50	\$2.905
CVL15-12x1 HİD.	15	11	12				122	115	106	95	87	66	\$3.725
CVL15-14x1 HİD.	15	11	14				158	150	140	126	116	89	\$3.815
CVL20-5x1 HİD.	7,5	5,5	5	2"	2"	Hm	8	12	16	20	24	28	\$2.855
CVL20-7x1 HİD.	10	7,5	7				68	65	61	55	46	33	\$3.085
CVL20-10x1 HİD.	15	11	9				96	92	86	77	65	47	\$3.945
CVL20-14x1 HİD.	20	15	14				137	132	124	112	98	73	\$4.480
							191	186	176	161	140	110	\$4.480



TEKNİK ÖZELLİKLER

Pompa:

- Pompa Gövdesi: AISI 304 Çelik
- Kademe Gömleği: AISI 304 Çelik
- Çark, Difüzör: AISI 304 Çelik
- Pompa Mil: AISI 304 Çelik
- Mekanik Salmastra sızdırmazlık (Karbon/Seramik/Viton)
- Çok Sesiz çalışma, düşük sarfiyat.
- Sıvı sıcaklığı: +5 °C ~ +90 °C
- Kollektör: AISI304 Çelik
- Şase: Çelik Sac (Titreşim önleyici kauçuk ayaklı)
- Susuz Çalışma Önleyici Seviye Flatörü
- Monometre ve Basınç Şalterli.
- Çek-Valf: Yaylı, sessiz
- Vana: Küresel (Bir Pompalı Hidroforlarda opsiyonel)

Pano:

- Motor & Faz Koruma Rölesi,
- Termik Manyetik Şalter,
- Kumanda Sigortası Donanımı
- Sıralı Çalıştırma Sistemi (Eş yaşlandırma)
- Susuz çalışma önleyici
- İkaz Ledleri (Susuz - Voltaj - Faz - Çalışma-Arıza)

KULLANIM ALANLARI

- Apartmanlar, siteler
- Okul, iş ve alışveriş merkezleri
- Sosyal tesisler
- Yangın söndürme sistemleri
- Su dağıtım istasyonları
- Filtre sistemleri (Ters ozmoz)

Not:

- Emiş Yapan Hidroforlarda Emiş Kollektörü Kullanılmaz. Her Pompaya ayrı emiş borusu ve dip klapesi olmalıdır.
- Motorlarınızın sorunsuz çalışabilmesi ancak Motor Koruma Sistemli Panoların kullanımı ile mümkündür.

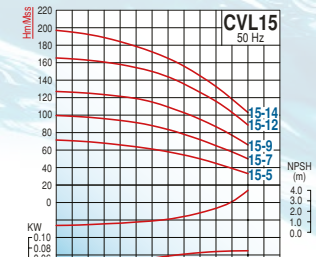
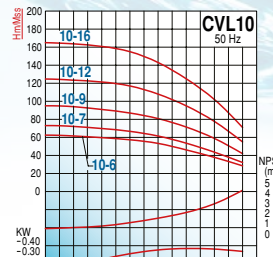
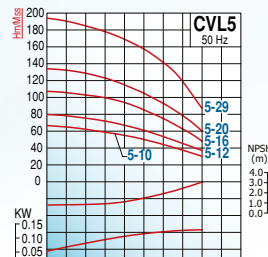
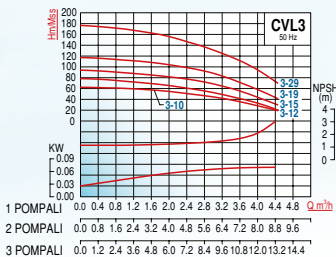
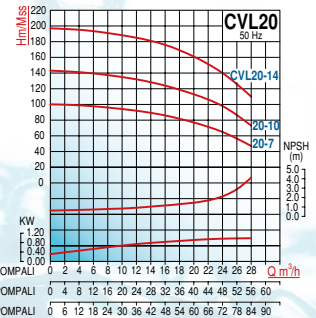

CVL

PASLANMAZ POMPALI PAKET HİDROFORLAR (Tank ve Bağlantı Hortumu Hariçtir)

PACKAGED BOOSTER SETS (Excluding pressure tank and flexible hose)

İKİ POMPALI HİDROFORLAR / TWO-PUMP BOOSTER SETS

TİP TYPE	MOTOR		KADEME STAGE	KOLLEKTÖR		m ³ /h	DEBİ (Q) - CAPACITY						FİYAT PRICE (USD)
	HP	kW		Giriş Inlet	Çıkış Outlet		2	4	5	6	7	8	
CVL3-10x2 HİD.	1	0,75	10	1,5"	1,5"	Hİ	60	55	50	43	36	28	\$3.475
CVL3-12x2 HİD.	1,5	1,1	12				72	66	59	52	44	34	\$3.535
CVL3-15x2 HİD.	1,5	1,1	15				90	82	77	69	60	44	\$3.620
CVL3-19x2 HİD.	2	1,5	19				113	104	98	88	77	58	\$3.910
CVL3-29x2 HİD.	3	2,2	29				170	156	147	132	118	93	\$4.340
CVL5-10x2 HİD.	2	1,5	10	2"	2"	Hİ	4	6	8	10	13	16	\$3.745
CVL5-12x2 HİD.	3	2,2	12				62	59	55	50	41	30	\$3.880
CVL5-16x2 HİD.	3	2,2	16				75	73	68	62	49	36	\$4.055
CVL5-20x2 HİD.	4	3	20				103	100	94	85	69	48	\$4.410
CVL5-29x2 HİD.	5,5	4	29				129	122	115	105	86	60	\$5.060
CVL10-6x2 HİD.	3	2,2	6	2,5"	2,5"	Hİ	4	12	16	20	24	28	\$4.295
CVL10-7x2 HİD.	4	3	7				62	58	53	46	38	28	\$4.500
CVL10-9x2 HİD.	4	3	9				73	67	61	54	43	32	\$4.690
CVL10-12x2 HİD.	5,5	4	12				93	87	81	71	59	42	\$5.110
CVL10-16x2 HİD.	7,5	5,5	16				123	117	108	95	78	55	\$5.970
CVL15-5x2 HİD.	5,5	4	5	3"	3"	Hİ	16	24	30	36	40	48	\$4.955
CVL15-7x2 HİD.	7,5	5,5	7				68	61	56	50	45	33	\$5.730
CVL15-9x2 HİD.	10	7,5	9				94	88	80	71	64	50	\$6.075
CVL15-12x2 HİD.	15	11	12				122	115	106	95	87	66	\$8.075
CVL15-14x2 HİD.	15	11	14				158	150	140	126	116	89	\$8.250
CVL20-5x2 HİD.	7,5	5,5	5	3"	3"	Hİ	16	24	32	40	48	56	\$6.015
CVL20-7x2 HİD.	10	7,5	7				68	65	61	55	46	33	\$6.460
CVL20-10x2 HİD.	15	11	9				96	92	86	77	65	47	\$8.580
CVL20-14x2 HİD.	20	15	14				137	132	124	112	98	73	\$9.400
							191	186	176	161	140	110	\$9.400



Sıralama rölesi (Eş Yaşlandırma) ilavesi: 60 USD

TEKNİK ÖZELLİKLER

Pompa:

- Pompa Gövdesi: AISI 304 Çelik
- Kademe Gömleği: AISI 304 Çelik
- Çark, Difüzör: AISI 304 Çelik
- Pompa Mili: AISI 304 Çelik
- Mekanik Salmastra sızdırmazlık (Karbon/Seramik/Viton)
- Çok Sesiz çalışma, düşük sarfiyat.
- Sıvı sıcaklığı: +5 °C ~ +90 °C
- Kollektör: AISI304 Çelik
- Şase: Çelik Sac (Titreşim önleyici kauçuk ayaklı)
- Susuz Çalışma Önleyici Seviye Flatörü
- Monometre ve Basınç Şalterli.
- Çek-Valf: Yaylı, sessiz
- Vana: Küresel (Bir Pompalı Hidroforlarda opsiyonel)

Pano:

- Motor & Faz Koruma Rölesi,
- Termik Manyetik Şalter,
- Kumanda Sigortası Donanımı
- Sıralı Çalıştırma Sistemi (Eş yaşlandırma)
- Susuz çalışma önleyici
- İkaz Ledleri (Susuz - Voltaj - Faz - Çalışma-Arıza)

KULLANIM ALANLARI

- Apartmanlar, siteler
- Okul, iş ve alışveriş merkezleri
- Sosyal tesisler
- Yangın söndürme sistemleri
- Su dağıtım istasyonları
- Filtre sistemleri (Ters ozmoz)

Not:

- Emiş Yapan Hidroforlarda Emiş Kollektörü Kullanılmaz. Her Pompaya ayrı emiş borusu ve dip klapsi olmalıdır.
- Motorlarınızın sorunsuz çalışabilmesi ancak Motor Koruma Sistemli Panoların kullanımı ile mümkündür.

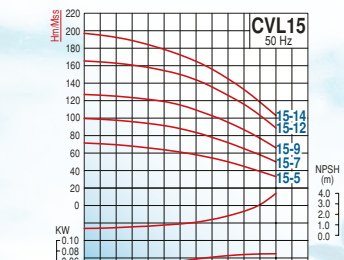
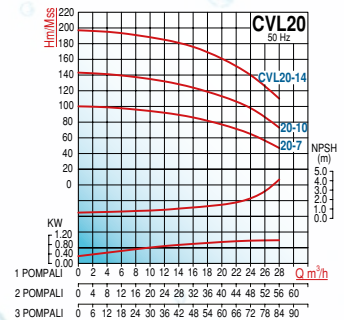
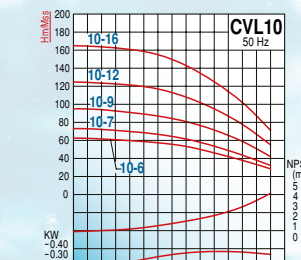
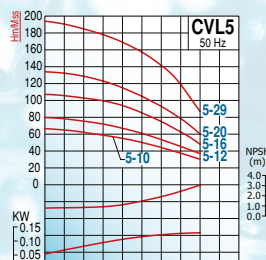
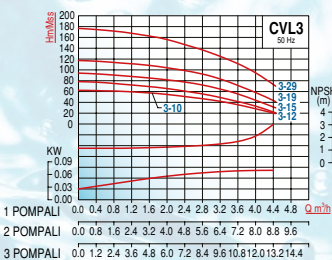

CVL

PAKET HİDROFORLAR (Tank ve Bağlantı Hortumu Hariçtir)

PACKAGED BOOSTER SETS (Excluding pressure tank and flexible hose)

ÜÇ POMPALI HİDROFORLAR / THREE-PUMP BOOSTER SETS

TİP TYPE	MOTOR		KADEME STAGE	KOLLEKTÖR		m ³ /h	DEBİ (Q) - CAPACITY						FİYAT PRICE (USD)
	HP	kW		Giriş Inlet	Çıkış Outlet		3	6	7,5	9	10,5	12	
CVL3-10x3 HİD.	1	0,75	10	2"	2"	Hm	60	55	50	43	36	28	\$5.560
CVL3-12x3 HİD.	1,5	1,1	12				72	66	59	52	44	34	\$5.655
CVL3-15x3 HİD.	1,5	1,1	15				90	82	77	69	60	44	\$5.780
CVL3-19x3 HİD.	2	1,5	19				113	104	98	88	77	58	\$6.215
CVL3-29x3 HİD.	3	2,2	29				156	147	132	118	93	\$6.860	
CVL5-10x3 HİD.	2	1,5	10	2.5"	2.5"	Hm	6	9	12	15	19,5	24	\$5.960
CVL5-12x3 HİD.	3	2,2	12				62	59	55	50	41	30	\$6.165
CVL5-16x3 HİD.	3	2,2	16				75	73	68	62	49	36	\$6.430
CVL5-20x3 HİD.	4	3	20				103	100	94	85	69	48	\$6.965
CVL5-29x3 HİD.	5,5	4	29				129	122	115	105	86	60	\$7.935
CVL10-6x3 HİD.	3	2,2	6	3"	3"	Hm	6	18	24	30	36	42	\$6.950
CVL10-7x3 HİD.	4	3	7				62	58	53	46	38	28	\$7.255
CVL10-9x3 HİD.	4	3	9				73	67	61	54	43	32	\$7.540
CVL10-12x3 HİD.	5,5	4	12				93	87	81	71	59	42	\$8.170
CVL10-16x3 HİD.	7,5	5,5	16				123	117	108	95	78	55	\$9.460
CVL15-5x3 HİD.	5,5	4	5	3"	3"	Hm	24	36	45	54	60	72	\$8.210
CVL15-7x3 HİD.	7,5	5,5	7				68	61	56	50	45	33	\$9.375
CVL15-9x3 HİD.	10	7,5	9				94	88	80	71	64	50	\$9.890
CVL15-12x3 HİD.	15	11	12				122	115	106	95	87	66	\$12.925
CVL15-14x3 HİD.	15	11	14				158	150	140	126	116	89	\$13.185
CVL20-5x3 HİD.	7,5	5,5	5	4"	4"	Hm	24	36	48	60	72	84	\$9.875
CVL20-7x3 HİD.	10	7,5	7				68	65	61	55	46	33	\$10.545
CVL20-10x3 HİD.	15	11	9				96	92	86	77	65	47	\$13.755
CVL20-14x3 HİD.	20	15	14				137	132	124	112	98	73	\$14.930
							191	186	176	161	140	110	\$14.930



Sıralama rölesi (Eş Yaşlandırma) ilavesi: 60 USD

TEKNİK ÖZELLİKLER

Pompa:

- Pompa Gövdesi: AISI 304 Çelik
- Kademe Gömleği: AISI 304 Çelik
- Çark, Difüzör: AISI 304 Çelik
- Pompa Mil: AISI 304 Çelik
- Mekanik Salmastra sızdırmazlık (Karbon/Seramik/Viton)
- Çok Sesiz çalışma, düşük sarfiyat.
- Sıvı sıcaklığı: +5 °C ~ +90 °C
- Kollektör: AISI304 Çelik
- Şase: Çelik Sac (Titreşim önleyici kauçuk ayaklı)
- Susuz Çalışma Önleyici Seviye Flatörü
- Monometre ve Basınç Şalterli.
- Çek-Valf: Yaylı, sessiz
- Vana: Küresel (Bir Pompalı Hidroforlarda opsiyonel)

Pano:

- Motor & Faz Koruma Rölesi,
- Termik Manyetik Şalter,
- Kumanda Sigortası Donanımı
- Sıralı Çalıştırma Sistemi (Eş yaşlandırma)
- Susuz çalışma önleyici
- İkaz Ledleri (Susuz - Voltaj - Faz - Çalışma-Arıza)

KULLANIM ALANLARI

- Apartmanlar, siteler
- Okul, iş ve alışveriş merkezleri
- Sosyal tesisler
- Yangın söndürme sistemleri
- Su dağıtım istasyonları
- Filtre sistemleri (Ters ozmoz)

Not:

- Emiş Yapan Hidroforlarda Emiş Kollektörü Kullanılmaz. Her Pompaya ayrı emiş borusu ve dip klapesi olmalıdır.
- Motorlarınızın sorunsuz çalışabilmesi ancak Motor Koruma Sistemli Panoların kullanımı ile mümkündür.

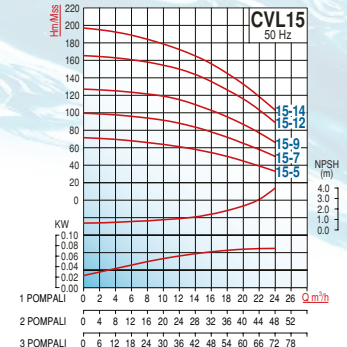
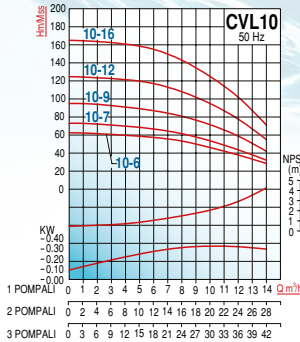
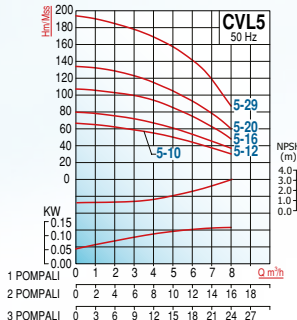
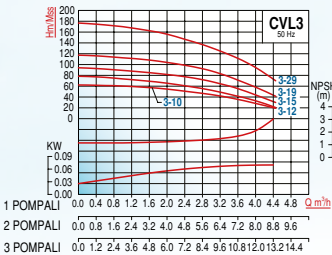
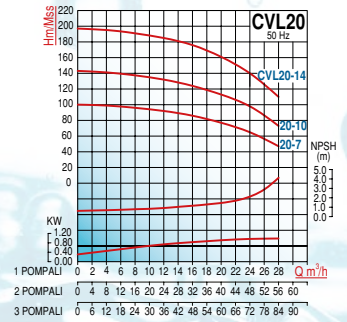

CVF

PAKET HİDROFORLAR (Tank ve Bağlantı Hortumu Hariçtir)

PACKAGED BOOSTER SETS (Excluding pressure tank and flexible hose)

BİR POMPALI HİDROFORLAR / TWO-PUMP BOOSTER SETS

TİP TYPE	MOTOR		KADEME STAGE	KOLLEKTÖR		m ³ /h	DEBİ (Q) - CAPACITY						FİYAT PRICE (USD)
	HP	kW		Giriş Inlet	Çıkış Outlet		12	20	24	30	36	40	
CVF32-4x1 HİD.	10	7,5	4	2½"	2½"	Hm	72	66	62	53	42	34	\$3.750
CVF32-5x1 HİD.	15	11	5				91	83	78	66	53	42	\$4.675
CVF32-6x1 HİD.	15	11	6				109	101	95	83	65	52	\$4.795
CVF32-8x1 HİD.	20	15	8				143	134	126	111	88	70	\$5.390
CVF32-10x1 HİD.	25	18,5	10				179	169	162	142	114	88	\$5.845
CVF32-12x1 HİD.	30	22	12				214	203	194	171	137	107	\$6.755
CVF45-3x1 HİD.	15	11	3	3"	3"	Hm	25	30	35	45	50	55	\$4.670
CVF45-4x1 HİD.	20	15	4				72	70	67	58	53	45	\$5.110
CVF45-5x1 HİD.	25	18,5	5				98	94	87	77	70	61	\$5.470
CVF45-6x1 HİD.	30	22	6				123	118	112	97	88	77	\$6.280
CVF45-9-2x1 HİD.	40	30	9				147	141	135	118	107	94	\$8.095
CVF64-3-1x1 HİD.	20	15,0	3	4"	4"	Hm	30	40	50	64	70	80	\$6.780
CVF64-4-2x1 HİD.	25	18,5	4				73	69	63	53	48	39	\$7.145
CVF64-4x1 HİD.	30	22	4				92	87	80	66	60	49	\$7.820
CVF64-6-2x1 HİD.	40	30	6				107	101	94	80	74	61	\$9.450
CVF90-2x1 HİD.	20	15,0	2	4"	4"	Hm	50	70	80	90	100	110	\$6.670
CVF90-3-2x1 HİD.	25	18,5	3				56	49	45	40	35	30	\$7.110
CVF90-3x1 HİD.	30	22	3				68	60	55	49	41	33	\$7.785
CVF90-4-2x1 HİD.	40	30	4				83	73	67	61	54	47	\$9.280



TEKNİK ÖZELLİKLER

Pompa:

- Pompa Gövdesi: AISI 304 Döküm Çelik
- Kademe Gömleği: AISI 304 Çelik
- Çark, Difüzör: AISI 304 Çelik
- Pompa Mili: AISI 304 Çelik
- Mekanik Salmastra sızdırmazlık (Karbon/Seramik/Viton)
- Çok Sesiz çalışma, düşük sarfiyat.
- Sıvı sıcaklığı: +5 °C ~ +90 °C
- Çelik Çek-Valf ve Vana donanımı (Opsiyonel)
- Şase: Çelik Sac (Titreşim önleyici kauçuk ayaklı)
- Susuz Çalışma Önleyici Seviye Flatürü
- Monometre ve Basınç Şalteri.
- Çek-Valf: Yaylı, sessiz
- Vana: Küresel (Bir Pompalı Hidrofor- lar da opsiyonel)

Pano:

- Motor & Faz Koruma Rölesi,
- Termik Manyetik Şalter,
- Kumanda Sigortası Donanımı
- Sıralı Çalıştırma Sistemi (Eş yağlandırma)
- Susuz çalışma önleyici
- İkaz Ledleri (Susuz - Voltaj - Faz - Çalışma-Arıza)

KULLANIM ALANLARI

- Apartmanlar, siteler
- Okul, iş ve alışveriş merkezleri
- Sosyal tesisler
- Yangın söndürme sistemleri
- Su dağıtım istasyonları
- Filtre sistemleri (Ters ozmoz)

Not:

- Emiş Yapan Hidroforlarda Emiş Kollektörü Kullanılmaz. Her Pompaya ayrı emiş borusu ve dip klape olmalıdır.
- Motorlarınızın sorunsuz çalışabilmesi ancak Motor Koruma Sistemli Pano ların kullanımı ile mümkündür.

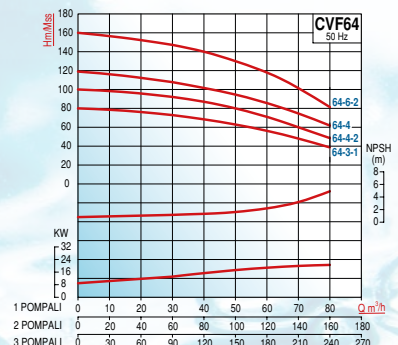
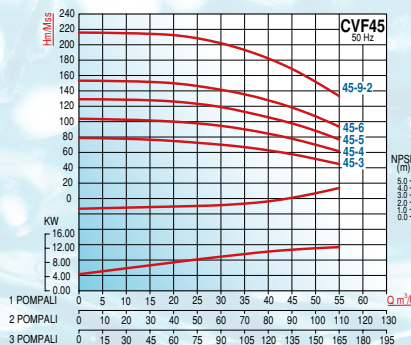
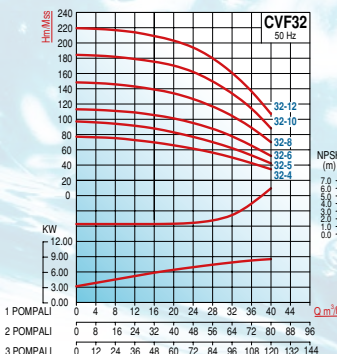
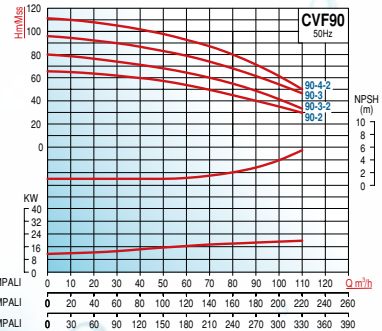

CVF

PAKET HİDROFORLAR (Tank ve Bağlantı Hortumu Hariçtir)

PACKAGED BOOSTER SETS (Excluding pressure tank and flexible hose)

İKİ POMPALI HİDROFORLAR / TWO-PUMP BOOSTER SETS

TİP TYPE	MOTOR		KADEME STAGE	KOLLEKTÖR		m ³ /h	DEBİ (Q) - CAPACITY						FİYAT PRICE (USD)
	HP	kW		Giriş Inlet	Çıkış Outlet		24	40	48	60	72	80	
CVF32-4x2 HİD.	10	7,5	4	3"	3"	Hm	72	66	62	53	42	34	\$7.955
CVF32-5x2 HİD.	15	11	5				91	83	78	66	53	42	\$10.200
CVF32-6x2 HİD.	15	11	6				109	101	95	83	65	52	\$10.435
CVF32-8x2 HİD.	20	15	8				143	134	126	111	88	70	\$11.385
CVF32-10x2 HİD.	25	18,5	10				179	169	162	142	114	88	\$12.330
CVF32-12x2 HİD.	30	22	12				214	203	194	171	137	107	\$14.160
CVF45-3x2 HİD	15	11	3	4"	4"	Hm	50	60	70	90	100	110	\$11.175
CVF45-4x2 HİD.	20	15	4				72	70	67	58	53	45	\$11.815
CVF45-5x2 HİD.	25	18,5	5				98	94	87	77	70	61	\$12.560
CVF45-6x2 HİD.	30	22	6				123	118	112	97	88	77	\$14.175
CVF45-9-2x2 HİD.	40	30	9				147	141	135	118	107	94	\$17.995
CVF64-3-1x2 HİD.	20	15,0	3	5"	5"	Hm	60	80	100	128	140	160	\$16.595
CVF64-4-2x2 HİD.	25	18,5	4				73	69	63	53	48	39	\$17.360
CVF64-4x2 HİD.	30	22	4				92	87	80	66	60	49	\$18.705
CVF64-6-2x2 HİD.	40	30	6				107	101	94	80	74	61	\$22.155
CVF90-2x2 HİD.	20	15,0	2	5"	5"	Hm	100	140	160	180	200	220	\$16.380
CVF90-3-2x2 HİD.	25	18,5	3				56	49	45	40	35	30	\$17.290
CVF90-3x2 HİD.	30	22	3				68	60	55	49	41	33	\$18.625
CVF90-4-2x2 HİD.	40	30	4				83	73	67	61	54	47	\$21.815



Sıralama rölesi (Eş Yaşlandırma) ilavesi: 60 USD

TEKNİK ÖZELLİKLER

Pompa:

- Pompa Gövdesi: AISI 304 Döküm Çelik
- Kademe Gömleği: AISI 304 Çelik
- Çark, Difüzör: AISI 304 Çelik
- Pompa Mili: AISI 304 Çelik
- Mekanik Salmastra sızdırmazlık (Karbon/Seramik/Viton)
- Çok Sesiz çalışma, düşük sarfiyat.
- Sıvı sıcaklığı: +5 °C ~ +90 °C
- Çelik Çek-Valf ve Vana donanımı (Opsiyonel)
- Sase: Çelik Sac (Titreşim önleyici kauçuk ayaklı)
- Susuz Çalışma Önleyici Seviye Flatörü
- Monometre ve Basınç Şalteri.
- Çek-Valf: Yaylı, sessiz
- Vana: Küresel (Bir Pompalı Hidroforlarda opsiyonel)

Pano:

- Motor & Faz Koruma Rölesi,
- Termik Manyetik Şalter,
- Kumanda Sigortası Donanımlı
- Sıralı Çalıştırma Sistemi (Eş Yaşlandırma)
- Susuz çalışma önleyici
- İkaz Ledleri (Susuz - Voltaj - Faz - Çalışma-Arıza)

KULLANIM ALANLARI

- Apartmanlar, siteler
- Okul, iş ve alışveriş merkezleri
- Sosyal tesisler
- Yangın söndürme sistemleri
- Su dağıtım istasyonları
- Filtre sistemleri (Ters ozmoz)

Not:

- Emiş Yapan Hidroforlarda Emiş Kollektörü Kullanılmaz. Her Pompaya ayrı emiş borusu ve dip klapesi olmalıdır.
- Motorlarınızın sorunsuz çalışabilmesi ancak Motor Koruma Sistemi Panoların kullanımı ile mümkündür.

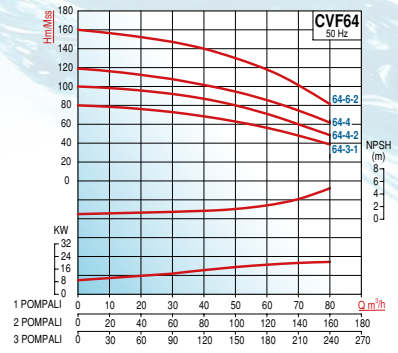
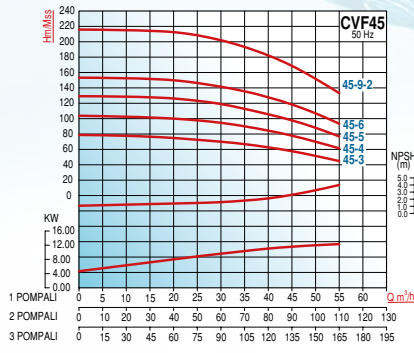
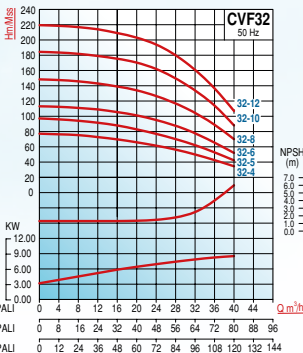
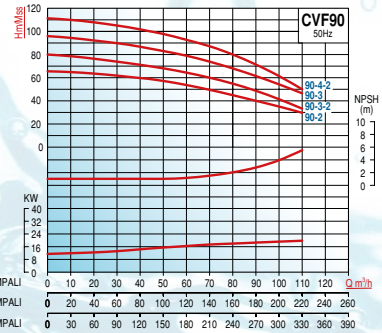

CVF

PAKET HİDROFORLAR (Tank ve Bağlantı Hortumu Hariçtir)

PACKAGED BOOSTER SETS (Excluding pressure tank and flexible hose)

ÜÇ POMPALI HİDROFORLAR / THREE-PUMP BOOSTER SETS

TİP TYPE	MOTOR		KADEME STAGE	KOLLEKTÖR		m ³ /h	DEBİ (Q) - CAPACITY						FİYAT PRICE (USD)
	HP	kw		Giriş Inlet	Çıkış Outlet		36	60	72	90	108	120	
CVF32-4x3 HİD.	10	7,5	4	4"	4"	Hm	72	66	62	53	42	34	\$13.005
CVF32-5x3 HİD.	15	11	5				91	83	78	66	53	42	\$16.405
CVF32-6x3 HİD.	15	11	6				109	101	95	83	65	52	\$16.760
CVF32-8x3 HİD.	20	15	8				143	134	126	111	88	70	\$18.125
CVF32-10x3 HİD.	25	18,5	10				179	169	162	142	114	88	\$19.510
CVF32-12x3 HİD.	30	22	12				214	203	194	171	137	107	\$22.425
CVF45-3x3 HİD	15	11	3	5"	5"	Hm	75	90	105	135	150	165	\$17.505
CVF45-4x3 HİD.	20	15	4				72	70	67	58	53	45	\$18.405
CVF45-5x3 HİD.	25	18,5	5				98	94	87	77	70	61	\$19.490
CVF45-6x3 HİD.	30	22	6				123	118	112	97	88	77	\$22.075
CVF45-9-2x3 HİD.	40	30	9				147	141	135	118	107	94	\$27.615
							209	202	193	169	152	133	\$27.615
CVF64-3-1x3 HİD.	20	15,0	3	6"	6"	Hm	90	120	150	192	210	240	\$25.335
CVF64-4-2x3 HİD.	25	18,5	4				73	69	63	53	48	39	\$26.440
CVF64-4x3 HİD.	30	22	4				92	87	80	66	60	49	\$28.625
CVF64-6-2x3 HİD.	40	30	6				107	101	94	80	74	61	\$33.610
				147	140	130	112	101	81	\$33.610			
CVF90-2x3 HİD.	20	15,0	2	6"	6"	Hm	150	210	240	270	300	330	\$25.005
CVF90-3-2x3 HİD.	25	18,5	3				56	49	45	40	35	30	\$26.340
CVF90-3x3 HİD.	30	22	3				68	60	55	49	41	33	\$28.510
CVF90-4-2x3 HİD.	40	30	4				83	73	67	61	54	47	\$33.095
				98	87	80	72	62	50	\$33.095			



Sıralama rölesi (Eş Yaşlandırma) ilavesi: 60 USD

TEKNİK ÖZELLİKLER

Pompa:

- Pompa Gövdesi: AISI 304 Döküm Çelik
- Kademe Gömleği: AISI 304 Çelik
- Çark, Difüzör: AISI 304 Çelik
- Pompa Mili: AISI 304 Çelik
- Mekanik Salmastra sızdırmazlık (Karbon/Seramik/Viton)
- Çok Sesiz çalışma, düşük sarfiyat.
- Sıvı sıcaklığı: +5 °C ~ +90 °C
- Çelik Çek-Valf ve Vana donanımı (Opsiyonel)
- Şase: Çelik Sac (Titreşim önleyici kauçuk ayaklı)
- Susuz Çalışma Ölçleyici Seviye Flatürü
- Monometre ve Basınç Şalteri.
- Çek-Valf: Yaylı, sessiz
- Vana: Küresel (Bir Pompalı Hidroforlarda opsiyonel)

Pano:

- Motor & Faz Koruma Rölesi,
- Termik Manyetik Şalter,
- Kumanda Sigortası Donanımlı
- Sıralı Çalıştırma Sistemi (Eş yaşlandırma)
- Susuz çalışma önleyici
- İlk Ledleri (Susuz - Voltaj - Faz - Çalışma-Arıza)

KULLANIM ALANLARI

- Apartmanlar, siteler
- Okul, iş ve alışveriş merkezleri
- Sosyal tesisler
- Yangın söndürme sistemleri
- Su dağıtım istasyonları
- Filtre sistemleri (Ters ozmoz)

Not:

- Emiş Yapan Hidroforlarda Emiş Kollektörü Kullanılmaz. Her Pompaya ayrı emiş borusu ve dip klapesi olmalıdır.
- Motorlarınızın sorunsuz çalışabilmesi ancak Motor Koruma Sistemli Panoların kullanımı ile mümkündür.

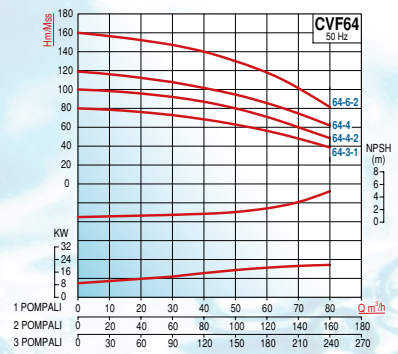
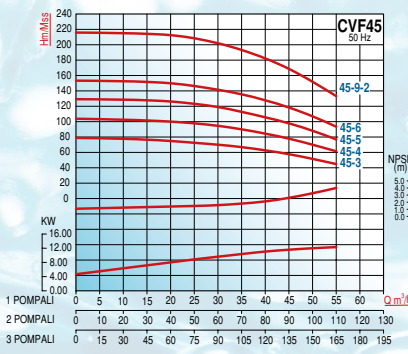
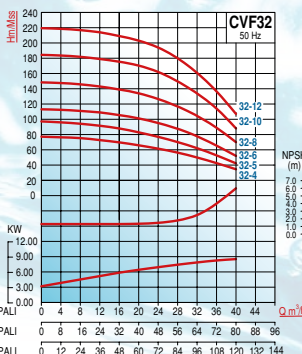
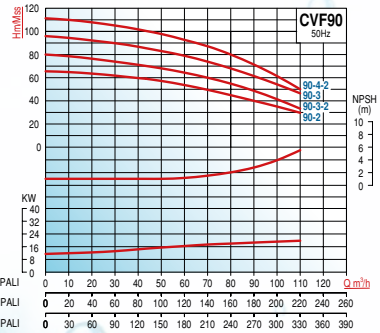

HİDROFOR TANKLARI (Membranlı)

TİP	AĞIZ	ÇALIŞMA BASINCI BAR	ÇAP (mm)	YÜKSEKLİK (mm)	AĞIRLIK (kg)	FİYAT (USD)	16 BAR FİYAT (USD)
24 LT (KÜRE)	1"	6	350	380	3,6	\$40	-
50 LT (YATIK)		8	370	405	8,4	\$95	-
50 LT (DİKEY)		8	370	695	8,8	\$70	\$110
80 LT (YATIK)		8	460	490	13,6	\$155	-
100 LT (YATIK)		8	460	490	14,8	\$170	-
100 LT (DİKEY)		8	460	840	14,9	\$135	\$190
150 LT (DİKEY)		8	460	1120	26,2	\$195	\$225
200 LT (DİKEY)		10	600	1030	35,2	\$235	\$400
300 LT (DİKEY)		10	640	1160	44,2	\$290	\$460
500 LT (DİKEY)		11/4"	10	750	1430	69,4	\$475
750 LT (DİKEY)*	10	750	1920	86	\$660	\$1.190	
1000 LT (DİKEY)*	2"	10	800	2120	153,4	\$865	\$1.555
1500 LT (DİKEY)*	2"	10	960	2430	267	\$1.465	\$2.245
2000 LT (DİKEY)*	2"	10	1100	2520	380	\$1.980	\$2.995

* İşaretili ürünler sadece fabrikamızdan teslim edilir.



FLEX HORTUM

BAĞLANTI	AÇIKLAMA	FİYAT (USD)
1"-1"	Paslanmaz Çelik örgü, 70 cm	\$12
1"-1"	Paslanmaz Çelik örgü, 80 cm	\$13
1"-1"	Paslanmaz Çelik örgü, 150 cm	\$18
1 1/4" - 1"	Paslanmaz Çelik örgü, 80 cm	\$25
1 1/4" - 1 1/4"	Paslanmaz Çelik örgü, 80cm	\$25
1 1/4" - 1 1/4"	Paslanmaz Çelik örgü, 150cm	\$32
2" - 2"	Paslanmaz Çelik örgü, 150 cm	\$62

NOT: 16 BAR VE ÜSTÜNE ÖNERİLMEZ



ELEKTRONİK HİDROFOR KİTLERİ

TİP TYPE	GİRİŞ	V	MAX AMP	MAX DEBİ	ÖZELLİK	FİYAT (USD)
	ÇIKIŞ					
PC-13A	1"	220	10 A	10 m ³ /h	Maximum 1 HP Pompalar içindir.	\$67



PC-13A

YANGIN POMPALARI ve HİDROFORLARI

FIRE FIGHTING PUMPS AND BOOSTER SYSTEMS

YANGIN POMPALARI

NFPA 20'ye uygun pompa özellikleri

- Her pompa için ayrı kumanda panosu kullanılır.
- Anma debisinde, emme borusundaki akış hızı 3 m/sn den küçük olacak şekilde boru sistemi tasarlanmalıdır.
- Sıfır debide max. basınç anma basıncının %140'ından fazla olmamalıdır.
- Pompa anma debisinin 1.5 katı değerinde basınç, anma değerinin %65'inden az olamaz.
- Debi, %150 olduğunda basınç, anma değerinin %65 altına düşmez
- Elektrik motorlarının servis faktörü (aşırı yüklenebilme çarpanı) 1.15'i geçmemelidir.
- Yataklama: Rulmanın ömrü en az 5000 saat
- Pompa çarkı: Bronz
- Pompa mili: AISI 316 veya AISI 304
- Pompa gövdesi: GG 25 Pik döküm
- Sızdırmazlık: 5 kat yumuşak salmastra
- Flanş: DIN 2533 PN16

Pompa ekipmanları

- Girişte ve Çıkışta basınç göstergeleri (monometre, vakummetre)
- Otomatik hava tahliye vanası
- Esnek kaplin
- Donmaya karşı sızdırma vanası
- Gövde soğutma vanası (casing relief valve)
- Hız düşürücü ekipmanlar

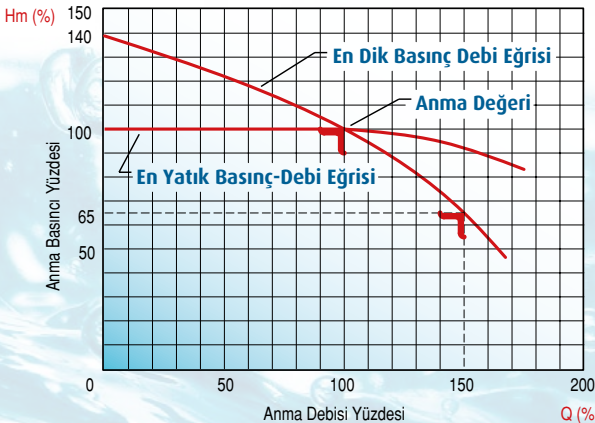

Yangın Hidroforları

(Elektrik ve Dizel Motorlu)

Fire Fighting Booster Sets

(Electric Motor ve Diesel Engine)

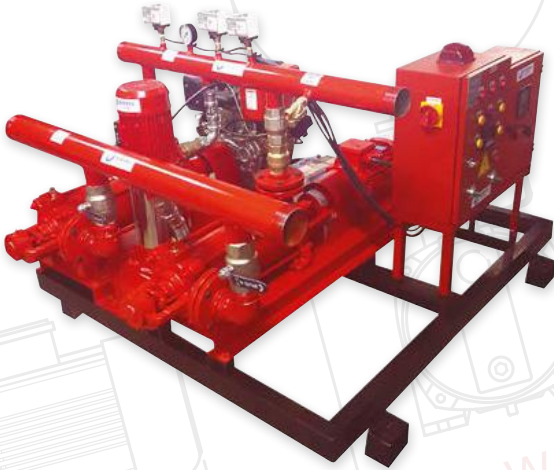

TEKNİK ÖZELLİKLER

Elektrikli gruplarda 30 - 130 mSS anma basıncı aralığında 5.7 m³/h - 340 m³/h (25 - 1500 gpm) anma debilerini sağlamaktadır. Kendini test edebilme özellikli panolu, jokey pompalı ve ışık-ses alarm donanımlı imal edilmektedir.

TECHNICAL DATA

These type of electrical fire fighting boosters have 5.7 - 340 m³/h (25 - 1500 gpm) capacity range at 30 - 130 m head range. These boosters are produced with Jokey Pump and Control panel (automatic-test function and fire alarm siren integrated.)

PVM

SERİSİ YANGIN HİDROFORLARI (Test Programlı, Siren-Işık Alarmlı)

SERIES FIRE FIGHTING BOOSTERS (Auto-Test Function and Fire Alarm equipped)

BİR POMPALI HİDROFORLAR / SINGLE-PUMP BOOSTER SETS

TİP TYPE	MOTOR (HP)	POMPA MODELİ	KADEME STAGE	KOLLEKTÖR GirişÇıkış InletxOutlet	m ³ /h	DEBİ (Q) - CAPACITY						FİYAT (USD)		
						Basınç (Bar)						Mono	Tri	
						1	4	6	12	18	24	220 V	380 V	
PVM4-4x1 Y.HİD.	1.5	VM4-4	4	2"	2"	5,3	4,9	4,5	2			\$1.015	\$1.020	
PVM2-7x1 Y.HİD.	1.5	VM2-7	7			8	6,5	4,5					\$1.100	\$1.090
PVM2-9x1 Y.HİD.	2	VM2-9	9			10,8	8	5,5					\$1.150	\$1.125
PVM4-6x1 Y.HİD.	2	VM4-6	6			8	7,5	6,8	3,5					\$1.090
PVM4-8x1 Y.HİD.	3	VM4-8	8			10,5	9,5	8,6	4,5					\$1.135
PVM12-6x1 Y.HİD.	4	VM12-6	6			6,6	6,3	6	5,2	4	2,5			\$1.230
PVM12-8x1 Y. HİD.	6.3	VM 12-8	8			8,7	8,5	7,7	6,6	4,2	3			\$1.420
PVM14-4x1 Y.HİD.	4	VM14-4	4			7,8	7,7	7,1	6,1	4,6	2,9			\$1.695
PVM14-5x1 Y.HİD.	5.5	VM14-5	5			9,7	9,4	9	7,2	5,2	3,4			\$1.835
PVM14-7x1 Y.HİD.	7.5	VM14-7	7			12,7	12,2	11,6	9,1	6,7	4,2			\$1.935



İKİ POMPALI HİDROFORLAR / TWO-PUMP BOOSTER SETS

TİP TYPE	MOTOR (HP)	POMPA MODELİ	KADEME STAGE	KOLLEK. GirişÇıkış InletxOutlet	m ³ /h	DEBİ (Q) - CAPACITY						FİYAT (USD)		
						Basınç (Bar)						Mono	Tri	
						2	8	12	24	36	48	220 V	380 V	
PVM4-4x2 Y.HİD.	1.5	VM4-4	4	2.5" x 2"	2.5"	5,3	4,9	4,5	2			\$1.820	\$1.840	
PVM2-7x2 Y.HİD.	1.5	VM2-7	7			8	6,5	4,5					\$2.000	\$1.980
PVM2-9x2 Y.HİD.	2	VM2-9	9			10,8	8	5,5					\$2.095	\$2.040
PVM4-6x2 Y.HİD.	2	VM4-6	6			8	7,5	6,8	3,5					\$1.975
PVM4-8x2 Y.HİD.	3	VM4-8	8			10,5	9,5	8,6	4,5					\$2.070
PVM12-6x2 Y.HİD.	4	VM12-6	6			6,6	6,3	6	5,2	4	2,5			\$2.290
PVM12-8x2 Y.HİD.	6.3	VM 12-8	8			8,7	8,5	7,7	6,6	4,2	3			\$2.670
PVM14-4x2 Y.HİD.	4	VM14-4	4			7,8	7,7	7,1	6,1	4,6	2,9			\$3.225
PVM14-5x2 Y.HİD.	5.5	VM14-5	5			9,7	9,4	9	7,2	5,2	3,4			\$3.500
PVM14-7x2 Y.HİD.	7.5	VM14-7	7			12,7	12,2	11,6	9,1	6,7	4,2			\$3.700



ÜÇ POMPALI HİDROFORLAR / THREE-PUMP BOOSTER SETS

TİP TYPE	MOTOR (HP)	POMPA MODELİ	KADEME STAGE	KOLLEK. GirişÇıkış InletxOutlet	m ³ /h	DEBİ (Q) - CAPACITY						FİYAT (USD)		
						Basınç (Bar)						Mono	Tri	
						3	12	18	36	54	72	220 V	380 V	
PVM4-4x3 Y.HİD.	1.5	VM4-4	4	2" x 2"	2"	5,3	4,9	4,5	2			\$2.600	\$2.625	
PVM2-7x3 Y.HİD.	1.5	VM2-7	7			8	6,5	4,5					\$2.865	\$2.835
PVM2-9x3 Y.HİD.	2	VM2-9	9			10,8	8	5,5					\$3.010	\$2.930
PVM4-6x3 Y.HİD.	2	VM4-6	6			8	7,5	6,8	3,5					\$2.830
PVM4-8x3 Y.HİD.	3	VM4-8	8			10,5	9,5	8,6	4,5					\$2.970
PVM12-6x3 Y.HİD.	4	VM12-6	6			6,6	6,3	6	5,2	4	2,5			\$3.305
PVM12-8x2 Y.HİD.	6.3	VM 12-8	8			8,7	8,5	7,7	6,6	4,2	3			\$3.875
PVM14-4x3 Y.HİD.	4	VM14-4	5			7,8	7,7	7,1	6,1	4,6	2,9			\$4.710
PVM14-5x3 Y.HİD.	5.5	VM14-5	5			9,7	9,4	9	7,2	5,2	3,4			\$5.125
PVM14-7x3 Y.HİD.	7.5	VM14-7	7			12,7	12,2	11,6	9,1	6,7	4,2			\$5.480

NOT:JOKEY POMPA FARKI = VM2-9x7= 855 USD, VM2-9x9= 890 USD, VM4-9x8= 900 USD

*HİDROFOR TANKI VE BAĞLANTI FLEKS HORTUMU HARİÇTİR.

-(*) 10 Bar üzeri sistemler 16 Bar'lık Tank ile kullanılmalıdır,

TEKNİK ÖZELLİKLER

Pano:

- Haftalık Test Programlı (Selonoid Valf Kontrollü)
- Siren-Işık Alarmlı
- Dijital Ayar Ekranı,
- Faz Gerilim Koruma özelliği,
- Motor Koruma (Ampermetrik)
- Yüksek Akıma Karşı Hassas Motor Koruma,
- Akım & Gerilim vs Değerlerin Ayarlanabildiği Menü Butonları
- Voltmetre & Ampermetre & Pompa Çalışma Süreleri, Koruma Gecikme Süreleri (Dijital Göstergeli)
- Sistem İkaz Ledleri (Susuz - Voltaj - Faz - Çalışma-Arıza)
- Sıralı veya Süreli Çalıştırma Yöntemi ile Eş Yaşlandırma
- Her Pompa için Otomatik - Manuel Test Butonu,

Pompa:

- Emiş & Basış Gövdesi: GG-25 PİK
- Kademe Gömleği: AISI 304 Çelik
- Çark , Difüzör Noryl (PPO)
- Pompa Mili AISI 304
- Sızdırmazlık: Mekanik Salmastra(Karbon/Seramik/NBR)
- Emiş ve Basış Kollektörü Dahil (Bir Pompalı Hidroforlarda Opsiyonel) (AISI 304 Çelik, 2" üzeri Demir Kollektör)
- Solonoid Valf (Çıkış Kollektörü Üzerinde)
- Çek-Valf: Yaylı, sessiz
- Vana: Küresel (Bir Pompalı Hidroforlarda opsiyonel)
- Şasi: Çelik sac(Titreşim önleyici kauçuk ayaklı)
- Manometre ve Basınç Şalterli.

KULLANIM ALANLARI

- Apartmanlar, siteler
- Okul, iş ve alışveriş merkezleri
- Sosyal tesisler

Not:

Emiş Yapan Hidroforlarda Emiş Kollektörü Kullanılmaz.
Her Pompaya ayrı emiş borusu ve dip klapesi olmalıdır.

VARAN YEDEK PARÇA FİYAT LİSTESİ

QB60 TL

Gövde Bronz Yat.	1.171 ₺
Araparça	920 ₺
Çark (Bronz)	686 ₺
Mek. Salmastra Ø 12	234 ₺

CPM158 (1" 1HP) TL

Gövde	1.355 ₺
Araparça	1.104 ₺
Çark (Bronz)	1.104 ₺
Mek. Salmastra Ø 14	234 ₺

THF6C-1 (2" 1.5HP) TL

Gövde	1.539 ₺
Araparça	1.171 ₺
Çark (Bronz)	1.355 ₺
Mek. Salmastra Ø 18	318 ₺

HFM-80 (3" 2HP) TL

Gövde	1.589 ₺
Araparça	1.104 ₺
Çark (Bronz)	1.489 ₺
Mek. Salmastra Ø 18	318 ₺

HFM-95 (4" 4HP) TL

Gövde	2.409 ₺
Araparça	1.589 ₺
Çark (Bronz)	2.091 ₺
Mek. Salmastra Ø 19	318 ₺

HFM-105 (4" 5.5HP) TL

Gövde	2.844 ₺
Araparça	1.823 ₺
Çark (Bronz)	2.476 ₺
Mek. Salmastra Ø 22	368 ₺

WQK (Bıçaklı Drenaj) TL

Tutma Kolu	418 ₺
Motor Üst Kapak	1.355 ₺
Motor Alt Kapak	686 ₺
Ara Parça	2.409 ₺
Pompa Gövde	4.784 ₺
Çark	1.706 ₺
Mek. Salmastra	4.784 ₺
Kablo 10 Mt)	2.559 ₺
Dirsek	1.706 ₺
Bıçak	1.890 ₺
Parçalayıcı Çember	1.890 ₺

Jet-100 TL

Gövde	1.890 ₺
Araparça	1.355 ₺
Difizör(Tk)	786 ₺
Enjektör (Tk)	686 ₺
Çark (Bronz)	1.104 ₺
Mek. Salmastra Ø 14	234 ₺

JET-180 TL

Gövde	2.258 ₺
Araparça	1.489 ₺
Difizör(Tk)	786 ₺
Enjektör (Tk)	686 ₺
Çark (Bronz)	1.355 ₺
Mek. Salmastra Ø 16	318 ₺

S JET Paslanmaz Jet TL

Gövde	2.024 ₺
Disk (Mek. Salmastra Yatağı)	1.104 ₺
Difizör(Tk)	786 ₺
Enjektör (Tk)	686 ₺
Çark (Bronz)	1.355 ₺
Motor Flanşı (Ara Parça)	970 ₺
Mek. Salmastra Ø 14	318 ₺

2TCP & 2HCP (Çift Kademe) TL

Gövde+Araparça	1.890 ₺
Kapak	1.355 ₺
Çark (Bronz)	1.355 ₺
Mek. Salmastra Ø 17	318 ₺
Disk	786 ₺

STM 5"DALGIÇ (Dipten Emişli) TL

Üst Kapak	1.355 ₺
Gövde	2.409 ₺
Emiş Süzgeçi	786 ₺
Motor Alt Flanşı	970 ₺
Kademe+Difizör	686 ₺
Çark	418 ₺
Mek. Salmastra(2 TK)	1.087 ₺
Alt Yatak	786 ₺
Mil	970 ₺
Mil Burcu	234 ₺
Motor Bağ.Halkası	234 ₺
Flatör	686 ₺
Kablo(20m)	1.589 ₺
Kumanda Kutusu	786 ₺

QDP Drenaj (Plastik) TL

Üst Gövde	719 ₺
Orta Gövde	719 ₺
Alt Gövde	686 ₺
Çark	569 ₺
Mek. Salmastra Ø 12	368 ₺
Flatör	686 ₺
Kablo(10 Mt)	1.355 ₺

QDS Drenaj (Paslanmaz) TL

Üst Gövde	1.489 ₺
Orta Gövde	1.489 ₺
Alt Gövde	719 ₺
Çark	686 ₺
Mek. Salmastra Ø 12	368 ₺
Flatör	686 ₺
Kablo(10 Mt)	1.355 ₺

QDX Drenaj Yüksek İrtifa TL

Kapak	686 ₺
Gövde	786 ₺
Emiş	786 ₺
Süzgeç	602 ₺
Kulp	234 ₺
Çark	1.489 ₺
Mek. Salmastra Ø 14	368 ₺
Flatör	686 ₺
Kablo (10 Mt)	1.355 ₺

Drenaj Pik 2" (WQD) Pis su TL

Üst Kapak	1.355 ₺
Motor Gövde	1.489 ₺
Pompa Gövde	1.489 ₺
Emiş	920 ₺
Çark	920 ₺
Mek. Salmastra Ø 14	920 ₺
Flatör	686 ₺
Kablo (10 Mt)	1.355 ₺
Dirsek	686 ₺
Bıçak	1.104 ₺
Parçalayıcı	786 ₺

CUT (Bıçaklı Drenaj) TL

Üst Kapak	786 ₺
Motor Gövde	1.489 ₺
Pompa Gövde	1.489 ₺
Emiş	970 ₺
Çark	970 ₺
Mek. Salmastra	920 ₺
Kablo 10 Mt)	1.355 ₺
Dirsek	719 ₺
Bıçak	1.104 ₺
Parçalayıcı	786 ₺
Flatör	686 ₺

VARAN YEDEK PARÇA FİYAT LİSTESİ

Mini TL

Gövde	1.037 ₺
Ara Parça	887 ₺
Çark(Bronz)	602 ₺
Saplama Tk	251 ₺
Tek Pompa	2.777 ₺
Mek. Salmastra Ø 12	Syf.115

SP-1

Gövde	1.188 ₺
Ara Parça	1.037 ₺
Çark(Bronz)	669 ₺
Saplama Tk	251 ₺
Tek Pompa	3.479 ₺
Mek. Salmastra Ø 12	Syf.115

SP-215

Gövde	1.857 ₺
Ara Parça	1.455 ₺
Çark(Bronz)	920 ₺
Tek Pompa	4.349 ₺
Mek. Salmastra Ø19 Burgman	Syf.115

S-105

Gövde	1.740 ₺
Ara Parça	1.455 ₺
Çark(Plastik)	351 ₺
Çark(Alum.)	1.087 ₺
Tek Pompa	4.349 ₺
Mek. Salmastra Ø19 Burgman	Syf.115

S-134

Gövde	1.890 ₺
Ara Parça	1.673 ₺
Çark(Plastik)	351 ₺
Çark(Alum.)	1.087 ₺
Tek Pompa	3.763 ₺
Mek. Salmastra Ø19 Burgman	Syf.115

CS-11,CS-151 S-11,S-151

Gövde	4.433 ₺
Ara Parça	3.245 ₺
Çark(Plastik)	401 ₺
Çark(Alum.)	1.706 ₺
Tek Pompa	8.581 ₺
Mek. Salmastra Ø19 Burgman	Syf.115

CS-115,CS-155 S-115,S-155

Gövde	2.810 ₺	4.433 ₺
Ara Parça	3.529 ₺	3.245 ₺
Çark(Plastik)	401 ₺	401 ₺
Çark(Alum.)	1.706 ₺	1.706 ₺
Tek Pompa	7.243 ₺	8.581 ₺
Mek. Salmastra Ø19 Burgman	Syf.115	

CS-12,CS-152 CS-153,S12 S-152,S-153

Gövde	2.810 ₺	4.433 ₺
Ara Parça	3.529 ₺	3.245 ₺
Çark(Plastik)	502 ₺	502 ₺
Çark(Alum.)	1.706 ₺	1.706 ₺
Tek Pompa	7.243 ₺	8.581 ₺
Mek. Salmastra Ø19 Burgman	Syf.115	

CS-21,S-21

Gövde	2.894 ₺	4.433 ₺
Ara Parça	3.529 ₺	3.479 ₺
Çark(Pik)	856 ₺	856 ₺
Tek Pompa	7.795 ₺	9.250 ₺
Mek. Salmastra Ø19 Burgman	Syf.115	

CS-215,CS-22 S-215,S-22

Gövde	2.894 ₺	4.433 ₺
Ara Parça	3.529 ₺	3.479 ₺
Çark(Pik)	966 ₺	966 ₺
Tek Pompa	7.795 ₺	9.250 ₺
Mek. Salmastra Ø19 Burgman	Syf.115	

CS-23,S-23

Gövde	2.894 ₺	4.433 ₺
Ara Parça	3.529 ₺	3.479 ₺
Çark(Pik)	966 ₺	966 ₺
Tek Pompa	7.795 ₺	9.250 ₺
Mek. Salmastra Ø19 Burgman	Syf.115	

CS-315,CS-32 S-315,S-32

Gövde	3.881 ₺	5.386 ₺
Ara Parça	3.529 ₺	4.433 ₺
Çark(Pik)	1.166 ₺	1.166 ₺
Tek Pompa	8.631 ₺	11.357 ₺
Mek. Salmastra Ø19 Burgman	Syf.115	

CS-33,S-33

Gövde	3.881 ₺	5.386 ₺
Ara Parça	3.529 ₺	4.433 ₺
Çark(Pik)	1.166 ₺	1.166 ₺
Tek Pompa	8.631 ₺	11.357 ₺
Mek. Salmastra Ø19 Burgman	Syf.115	

S-34

Gövde	5.386 ₺
Ara Parça	4.700 ₺
Çark(Pik)	1.166 ₺
Tek Pompa	11.876 ₺
Mek. Salmastra Ø25 Burgman	Syf.115

VS-253

Gövde	4.048 ₺
Ara Parça	2.660 ₺
Çark(Pik)	1.896 ₺
Tek Pompa	9.501 ₺
Mek. Salmastra Ø19 Burgman	Syf.115

VS-254

Gövde	4.048 ₺
Ara Parça	2.660 ₺
Çark(Pik)	1.896 ₺
Tek Pompa	9.501 ₺
Mek. Salmastra Ø25 Burgman	Syf.115

VS-324, VS-325

Gövde	4.667 ₺
Ara Parça	2.743 ₺
Çark(Pik)	2.170 ₺
Tek Pompa	10.170 ₺
Mek. Salmastra Ø25 Burgman	Syf.115

Not: Mekanik salmastra fiyatları için 115. sayfaya bakınız.

VARAN YEDEK PARÇA FİYAT LİSTESİ

KS-115

Kapak	2.241 ₺
Gövde	3.412 ₺
Ara Parça	3.128 ₺
Çark(Plastik)	351 ₺
Çark(Alum.)	1.271 ₺
Saplama Tk.	251 ₺
O-ring	100 ₺
Tek Pompa	10.688 ₺
Mek. salmas. Ø19 Burgman	Syf.115

KS-12

Kapak	2.241 ₺
Gövde	3.412 ₺
Ara Parça	3.128 ₺
Çark(Plastik)	351 ₺
Çark(Alum.)	1.271 ₺
Saplama Tk.	251 ₺
O-ring	100 ₺
Tek Pompa	10.688 ₺
Mek. salmas. Ø19 Burgman	Syf.115

KS-142

Kapak	2.609 ₺
Gövde	4.483 ₺
Ara Parça	3.128 ₺
Çark(Plastik)	351 ₺
Çark(Alum.)	1.271 ₺
Saplama Tk.	251 ₺
O-ring	100 ₺
Tek Pompa	11.591 ₺
Mek. salmas. Ø19 Burgman	Syf.115
Burç	113 ₺

KS-143

Kapak	2.609 ₺
Gövde	4.483 ₺
Ara Parça	3.128 ₺
Çark(Plastik)	351 ₺
Çark(Alum.)	1.271 ₺
Saplama Tk.	251 ₺
Oring	100 ₺
Tek Pompa	11.709 ₺
Mek. salmas. Ø19 Burgman	Syf.115
Burç	113 ₺

KS-155 / KS-255

KKapak	3.312 ₺
Gövde	5.386 ₺
Ara Parça	2.174 ₺
Disk	1.188 ₺
Çark(Alum.)	1.890 ₺
Saplama Tk.	251 ₺
Klingrit Conta	100 ₺
Tek Pompa	15.288 ₺
Mek. salmas. Ø25 Burgman	Syf.115
Burç	113 ₺

KS-157,KS-27

Kapak	3.312 ₺
Gövde	5.386 ₺
Ara Parça	2.174 ₺
Disk	1.188 ₺
Çark(Alum.)	1.890 ₺
Saplama Tk.	251 ₺
Klingrit Conta	100 ₺
Tek Pompa	16.576 ₺
Mek. salmas. Ø25 Burgman	Syf.115
Burç	113 ₺

CH-11,CH-115

Gövde	4.081 ₺
Ara Parça	3.529 ₺
Dak Difizör	1.238 ₺
C Difizör Tk.	435 ₺
Flanş	251 ₺
Enjektör Tk.	251 ₺
Klape Last	251 ₺
Çark(Plastik)	401 ₺
Çark(Alum.)	920 ₺
Tek Pompa	9.216 ₺
Mek. salmas. Ø19 Burgman	Syf.115

H-11,H-115

Gövde	4.081 ₺
Ara Parça	3.529 ₺
Dak Difizör	1.238 ₺
C Difizör Tk.	435 ₺
Flanş	251 ₺
Enjektör Tk.	251 ₺
Klape Last	251 ₺
Çark(Plastik)	401 ₺
Çark(Alum.)	920 ₺
Tek Pompa	9.216 ₺
Mek. salmas. Ø19 Burgman	Syf.115

H-21, H-215, H-22, H-23

Alıcı	719 ₺
Alıcı Kapak	1.890 ₺
Gövde	7.795 ₺
Çark(Pik)	887 ₺
Klape Lastiği	251 ₺
Tek Pompa	12.629 ₺
Mek. salmas. Ø19 Burgman	Syf.115

Mekanik Salmastra

Ø12	6 €
Ø19 Burgman	11 €
Ø20 Burgman(VM)	69 €
Ø22 Burgman(VF) (Silisyumlu, Çift Takım)	102 €
Ø24 Burgman(CES) (Silisyumlu)	80 €
Ø25 Burgman	17 €
Ø25 (VF) (Silisyumlu, Çift Takım)	90 €
Ø28 Burgman (KD-VKD)	86 €
Ø30 (BS)	29 €
Ø30 (VF) (Silisyumlu, Çift Takım)	97 €
Ø32 Burgman(CES)(Silisyumlu)	91 €
Ø35 (VF) (Silisyumlu, Çift Takım) (10HP)	99 €
Ø40 (VF) (Silisyumlu, Çift Takım) (15HP)	200 €

TAPA

Tapa 1/4	184 ₺
Tapa 3/8	217 ₺
Tapa 1/2	268 ₺

KADEMELİ POMPA MİLİ FİYAT LİSTESİ (AISI420) (TL)

KADEME SAYISI	POMPA TİPİ							
	K40	K50	VK40	VK50	KD40	KD50	VKD40	VKD50
2			5.168 ₺	5.874 ₺			4.759 ₺	5.410 ₺
3	4.796 ₺	4.796 ₺	5.298 ₺	7.752 ₺			4.870 ₺	5.521 ₺
4	4.870 ₺	4.870 ₺	7.027 ₺	8.068 ₺	4.666 ₺	4.666 ₺	4.926 ₺	5.930 ₺
5	6.376 ₺	6.376 ₺	7.231 ₺	8.384 ₺	4.722 ₺	4.722 ₺	5.094 ₺	
6	6.413 ₺	6.413 ₺	7.436 ₺	8.700 ₺	4.759 ₺	4.759 ₺	5.298 ₺	
7	6.469 ₺	6.469 ₺	7.715 ₺	9.016 ₺	4.796 ₺	4.796 ₺		
8	6.488 ₺	6.488 ₺	7.975 ₺	9.443 ₺	4.870 ₺	4.870 ₺		
9	6.618 ₺	6.618 ₺	8.235 ₺	9.871 ₺	6.339 ₺	6.339 ₺		
10	7.789 ₺	7.789 ₺	8.495 ₺		6.376 ₺	6.376 ₺		
11	7.845 ₺	7.845 ₺	8.756 ₺					
12	7.901 ₺	7.901 ₺	9.555 ₺					

VARAN YEDEK PARÇA FİYAT LİSTESİ

K40 & K50

	TL
Alıcı Gövde	7.878 ₺
Verici Gövde	7.878 ₺
Kademe (Difüzörlü)	1.857 ₺
Çark(Pik)	1.421 ₺
Gövde Kapağı	987 ₺
Glend + Saplama Tk.	435 ₺
Verici Gövde Difüzörü	887 ₺
Kademe Difüzörü(K-22)	887 ₺
Mil Somunu Tk.	284 ₺
Kama	117 ₺
Saplama + Somun Adet	351 ₺
Salmastra Tk.(Emiş+Bası)	435 ₺
Dış Rulman Kapağı	435 ₺
İç Rulman Kapağı	251 ₺
Soğutma Borusu Tk.	602 ₺

KD40 & KD50

	TL
Alıcı Gövde	6.507 ₺
Verici Gövde	6.055 ₺
Tabla	3.763 ₺
Kademe (Difüzörlü)	1.857 ₺
Verici Gövde Difüzörü	887 ₺
Çark(Pik)	1.421 ₺
Ara Parça	6.507 ₺
Rulman Kapağı	435 ₺
Mek.Salmastra Ø28	Syf.115
Mek.Salmastra Baskısı	435 ₺
Bronz Yatak(burç)	2.500 ₺
Bronz Yatak Kapağı	569 ₺
Saplama + Somun Tk.	351 ₺
Mil Somunu Tk.	284 ₺
Soğutma Borusu Tk.	602 ₺
Kama	117 ₺

AS,CAS SERİSİ

	TL
Gövde	12.428 ₺
Ara Parça	4.633 ₺
Yatak	4.081 ₺
Çark(Pik)	3.154 ₺
Rulman Kapağı	435 ₺
Glend + Saplama Tk.	435 ₺
Mil	4.901 ₺
Mil Somunu	251 ₺
O-Ring	201 ₺
Salmastra (Teflon)	351 ₺
Tek Pompa(CAS)	21.571 ₺
Mek. Salmastra Ø25 Burgman	Syf.115
Kama	100 ₺

FLANŞ

	TL
1.5"	736 ₺
2"	803 ₺
3"	1.070 ₺
4"	1.472 ₺
5"	1.766 ₺

VK32

	TL
Alıcı Gövde	7.443 ₺
Verici Gövde	6.280 ₺
Ayak Alıcı Tarafı	3.610 ₺
Ayak Verici Tarafı	3.610 ₺
Kademe	2.608 ₺
Gövde Difüzörü	713 ₺
Çark(Pik)	1.482 ₺
Glend + Saplama Tk.	435 ₺
Rulman Kapağı	435 ₺
Salmastra Tk.(Emiş+Bası)	669 ₺
Kama	117 ₺
Saplama + Somun Adet	351 ₺
Mil Somunu Tk.	284 ₺
Soğutma Borusu	602 ₺
O-ring	134 ₺

VKD32

	TL
Alıcı Gövde	7.443 ₺
Verici Gövde	6.280 ₺
Tabla	3.893 ₺
Kademe	2.608 ₺
Gövde Difüzörü	713 ₺
Çark(Pik)	1.482 ₺
Ara Parça	6.360 ₺
Rulman Kapağı	435 ₺
Mek.Salmastra Ø28	Syf.115
M.Salmastra Baskısı	369 ₺
Bronz Yatak	2.500 ₺
Bronz Yatak Kapağı	482 ₺
Saplama + Somun Adet	340 ₺
Mil Somunu Tk.	241 ₺
Soğutma Borusu Tk.	510 ₺
O-ring	113 ₺
Kama	99 ₺

VK40

	TL
Alıcı Gövde	9.250 ₺
Verici Gövde	7.443 ₺
Ayak Alıcı Tarafı	3.763 ₺
Ayak Verici Tarafı	3.763 ₺
Kademe	2.241 ₺
Gövde Difüzörü	1.305 ₺
Çark(Pik)	1.896 ₺
Glend + Saplama Tk.	435 ₺
Rulman Kapağı	435 ₺
Salmastra Tk.(Emiş+Bası)	669 ₺
Kama	117 ₺
Saplama + Somun Adet	351 ₺
Mil Somunu Tk.	284 ₺
Soğutma Borusu	602 ₺
O-ring	134 ₺

VKD40

	TL
Alıcı Gövde	9.250 ₺
Verici Gövde	7.443 ₺
Tabla	3.763 ₺
Kademe	3.312 ₺
Gövde Difüzörü	1.305 ₺
Çark(Pik)	1.896 ₺
Ara Parça	7.995 ₺
Rulman Kapağı	435 ₺
Mek.Salmastra Ø28	Syf.115
M.Keçe Baskısı	435 ₺
Bronz Yatak	2.500 ₺
Bronz Yatak Kapağı	569 ₺
Saplama + Somun Adet	401 ₺
Mil Somunu Tk.	284 ₺
Soğutma Borusu Tk.	602 ₺
O-ring	134 ₺
Kama	117 ₺

VK50

	TL
Alıcı Gövde	11.959 ₺
Verici Gövde	8.397 ₺
Ayak Alıcı Tarafı	5.620 ₺
Ayak Verici Tarafı	5.620 ₺
Kademe	4.867 ₺
Gövde Difüzörü	1.673 ₺
Çark(Pik)	2.372 ₺
Glend + Saplama Tk.	636 ₺
Rulman Kapağı	435 ₺
Salmastra Tk.(Emiş+Bası)	669 ₺
Kama	117 ₺
Saplama + Somun Adet	351 ₺
Mil Somunu Tk.	669 ₺
Soğutma Borusu	602 ₺
O-ring	134 ₺

VKD50

	TL
Alıcı Gövde	11.959 ₺
Verici Gövde	8.397 ₺
Tabla	3.998 ₺
Kademe	4.901 ₺
Gövde Difüzörü	1.673 ₺
Çark(Pik)	2.372 ₺
Ara Parça 160 & 180 Tip	7.510 ₺
Ara Parça 200 Tip	11.240 ₺
Rulman Kapağı	435 ₺
Mek.Salmastra Ø28	Syf.115
M.Keçe Baskısı	786 ₺
Bronz Yatak	2.500 ₺
Bronz Yatak Kapağı	887 ₺
Saplama + Somun Adet	401 ₺
Mil Somunu Tk.	669 ₺
Soğutma Borusu Tk.	602 ₺
O-ring	134 ₺
Kama	117 ₺

BS SERİSİ

	TL
Gövde	14.686 ₺
Ara Parça	6.122 ₺
Yatak	3.763 ₺
Çark(Pik)	4.356 ₺
Rulman Kapağı	435 ₺
Glend + Saplama Tk.	435 ₺
Mil	5.152 ₺
Mil Somunu	251 ₺
O-ring	134 ₺
Salmastra (Teflon)	351 ₺
Mek.Salmastra Ø30	Syf.115
Kama	100 ₺

KAPLIN Ø/Mot. Tipi Adet Fiy.

Ø 80 Kaplin (100-112 Tip)	548 ₺
Ø 95 Kaplin (132 Tip)	765 ₺
Ø 110 Kaplin (160 Tip)	1.030 ₺
Ø 125 Kaplin (200-225 Tip)	1.465 ₺
Ø 140 Kaplin (250 Tip)	1.635 ₺
Ø 180 Kaplin (280 Tip)	3.175 ₺
Kaplin Lastiği Ø 80	213 ₺
Kaplin Lastiği Ø 95	250 ₺
Kaplin Lastiği Ø 110	269 ₺
Kaplin Lastiği Ø 125	340 ₺
Kaplin Lastiği Ø 140	425 ₺
Kaplin Lastiği Ø 180	836 ₺

Not: Mekanik salmastra fiyatları için 115. sayfaya bakınız.

VARAN YEDEK PARÇA FİYAT LİSTESİ

CM4 / CMI4 USD

Alıcı Gövde	94 \$
Verici Gövde	94 \$
Kademe (Difüzörlü)	43 \$
Çark (316)	36 \$
Çark(304)	12 \$
Araparça	29 \$
(Mot.Ön Kapak)	
Mot.Ayağı (Şase)	22 \$
Saplama (Adedi)	7 \$
Mek. Salmastra Ø16	29 \$
O-Ring	7 \$

CM8/CMI8/CMI10 USD

Alıcı Gövde	101 \$
Verici Gövde	101 \$
Kademe (Difüzörlü)	50 \$
Çark (316)	43 \$
Çark(304)	14 \$
Araparça	43 \$
(Mot.Ön Kapak)	
Mot.Ayağı (Şase)	22 \$
Saplama (Adedi)	7 \$
Mek. Salmastra Ø19	36 \$
O-Ring	7 \$

CMF USD

Gövde	108 \$
Ara Parça	58 \$
Difüzör	43 \$
Emiş Difüzörü	43 \$
Çıkış Difüzörü	43 \$
Pompa Kapağı	22 \$
Çark	50 \$
Mek. Salmastra (CMF4:Ø15)	36 \$
(CMF8, CMF12, CMF16:Ø15)	
Motor Ayağı (Şase)	22 \$
Gövde Çemberi	22 \$
Araparça Diski	43 \$
Motor Arka Flanş	43 \$

CVL3 USD

Gövde	303 \$
Çark	29 \$
Kademe (Difüzörlü)	36 \$
Çıkış Difüzörlü	36 \$
Gömlek	151 \$
Mil	130 \$
Alt Tabla	43 \$
Ara Parça	94 \$
Pompa Kapağı	65 \$
Mekanik Salmastra (Ø12)	188 \$
Hava Alma Tapası	22 \$
Tahliye Tapası	22 \$
O-ring	7 \$
Saplama (Adet)	22 \$

CVL5 USD

Gövde	303 \$
Çark	29 \$
Kademe (Difüzörlü)	36 \$
Çıkış Difüzörlü	36 \$
Gömlek	216 \$
Mil	180 \$
Alt Tabla	43 \$
Ara Parça	94 \$
Pompa Kapağı	94 \$
Mekanik Salmastra (Ø12)	188 \$
Hava Alma Tapası	22 \$
Tahliye Tapası	22 \$
O-ring	7 \$
Saplama (Adet)	29 \$

CVL10 USD

Gövde	303 \$
Çark	29 \$
Kademe (Difüzörlü)	36 \$
Çıkış Difüzörlü	36 \$
Gömlek	216 \$
Mil	180 \$
Alt Tabla	43 \$
Ara Parça	94 \$
Pompa Kapağı	94 \$
Mekanik Salmastra (Ø16)	188 \$
Hava Alma Tapası	22 \$
Tahliye Tapası	22 \$
O-ring	7 \$
Saplama (Adet)	29 \$

CVL15 USD

Gövde	303 \$
Çark	29 \$
Kademe (Difüzörlü)	36 \$
Çıkış Difüzörlü	36 \$
Gömlek	216 \$
Mil	180 \$
Alt Tabla	43 \$
Ara Parça	94 \$
Pompa Kapağı	94 \$
Mekanik Salmastra (Ø16)	188 \$
Hava Alma Tapası	22 \$
Tahliye Tapası	22 \$
O-ring	7 \$
Saplama (Adet)	29 \$

CVL20 USD

Gövde	303 \$
Çark	50 \$
Kademe (Difüzörlü)	36 \$
Çıkış Difüzörlü	36 \$
Gömlek	216 \$
Mil	180 \$
Alt Tabla	43 \$
Ara Parça	94 \$
Pompa Kapağı	94 \$
Mekanik Salmastra (Ø16)	188 \$
Hava Alma Tapası	22 \$
Tahliye Tapası	22 \$
O-ring	7 \$
Saplama (Adet)	29 \$

CVF32 USD

Gövde	1.872 \$
Çark	58 \$
Kademe (Difüzörlü)	127 \$
Çıkış Difüzörlü	127 \$
Gömlek	538 \$
Mil	262 \$
Alt Tabla	172 \$
Ara Parça	360 \$
Pompa Kapağı	942 \$
Mekanik Salmastra (Ø22)	188 \$
Hava Alma Tapası	22 \$
Tahliye Tapası	22 \$
O-ring	7 \$
Saplama (Adet)	29 \$

CVF45 USD

Gövde	2.064 \$
Çark	64 \$
Kademe (Difüzörlü)	151 \$
Çıkış Difüzörlü	151 \$
Gömlek	538 \$
Mil	262 \$
Alt Tabla	172 \$
Ara Parça	360 \$
Pompa Kapağı	1.027 \$
Mekanik Salmastra (Ø22)	188 \$
Hava Alma Tapası	22 \$
Tahliye Tapası	22 \$
O-ring	7 \$
Saplama (Adet)	29 \$

CVF64 USD

Gövde	2.070 \$
Çark	67 \$
Kademe (Difüzörlü)	162 \$
Çıkış Difüzörlü	162 \$
Gömlek	370 \$
Mil	182 \$
Alt Tabla	300 \$
Ara Parça	600 \$
Pompa Kapağı	1.036 \$
Mekanik Salmastra (Ø22)	188 \$
Hava Alma Tapası	22 \$
Tahliye Tapası	22 \$
O-ring	7 \$
Saplama (Adet)	29 \$

CVF90 TL

Gövde	2.442 \$
Çark	79 \$
Kademe (Difüzörlü)	276 \$
Çıkış Difüzörlü	276 \$
Gömlek	294 \$
Mil	160 \$
Alt Tabla	319 \$
Ara Parça	638 \$
Pompa Kapağı	1.224 \$
Mekanik Salmastra (Ø22)	188 \$
Hava Alma Tapası	22 \$
Tahliye Tapası	22 \$
O-ring	7 \$
Saplama (Adet)	29 \$

VM 2 TL

Alıcı Gövde	1.990 ₺
Verici Gövde	1.990 ₺
Kademe (Difüzörlü)	452 ₺
V.Gövde Difüzörü	452 ₺
Çark	268 ₺
Kapak (Disk)	0 ₺
Saplama (Ad)	268 ₺
Mek. Salmastra Ø19	318 ₺
Flanş(Ad)	318 ₺
Kademe Gömleği(çelik)	1.589 ₺

VM 4 TL

Alıcı Gövde	1.990 ₺
Verici Gövde	1.990 ₺
Kademe (Difüzörlü)	452 ₺
V.Gövde Difüzörü	452 ₺
Çark	268 ₺
Kapak (Disk)	0 ₺
Saplama (Ad)	268 ₺
Mek.Salmastra (VM4-4:Ø16), (VM4-6,VM4-8 :Ø19)	318 ₺
Flanş (Adet)	318 ₺
Kademe Gömleği(çelik)	1.589 ₺

VM 12 TL

Alıcı Gövde	2.375 ₺
Verici Gövde	2.158 ₺
Kademe (Difüzörlü)	485 ₺
V.Gövde Difüzörü	485 ₺
Çark	318 ₺
Şaplama (Ad)	401 ₺
Mek. Salmastra Ø19	703 ₺
Flanş (Adet)	318 ₺
Kademe Gömleği(çelik)	2.108 ₺

VM 14 TL

Alıcı Gövde	2.375 ₺
Verici Gövde	2.375 ₺
Kademe (Difüzörlü)	485 ₺
V.Gövde Difüzörü	485 ₺
Çark	318 ₺
Kapak (Disk)	268 ₺
Saplama (Ad)	401 ₺
Mek. Salmastra Ø20	SYF
Flanş(Ad)	318 ₺
Kademe Gömleği(çelik)	2.108 ₺

VARAN YEDEK PARÇA FİYAT LİSTESİ

DWB	USD
Gövde AISI316	166 \$
Gövde AISI304	130 \$
Ara Parça	58 \$
Pompa Kapağı AISI316	43 \$
Pompa Kapağı AISI304	36 \$
Çark AISI316	65 \$
Çark AISI304	50 \$
Mek. Salmastra Ø19	29 \$

DWK (Açık Çark)	USD
Gövde	166 \$
Ara Parça	58 \$
Pompa Kapağı	43 \$
Çark (Açık Kanat)	65 \$
Mek. Salmastra Ø19	29 \$
Ayak	29 \$

BLC	USD
Gövde AISI316	94 \$
Gövde AISI304	72 \$
Ara Parça	58 \$
Pompa Kapağı AISI316	58 \$
Pompa Kapağı AISI304	43 \$
Çark AISI316	58 \$
Çark AISI304	43 \$
Mek. Salmastra Ø16	29 \$
Soğutma Fan Kapağı	19 \$

CA & CY YEDEK PARÇA

50-32-160	USD
Gövde	469 \$
Araparça (Motor Ön Flanş)	180 \$
CY Yatak	116 \$
CY Mil	361 \$
Kapak	43 \$
Mek. Salmastra Ø25	50 \$
Çark (316)	144 \$
Çark (304)	72 \$
Soğutma Fan Kapağı	25 \$
Motor Arka Kapak	27 \$

50-32-200	USD
Gövde	490 \$
Araparça (Motor Ön Flanş)	180 \$
CY Yatak	156 \$
CY Mil	361 \$
Kapak	65 \$
Mek. Salmastra Ø25	50 \$
Çark (316)	187 \$
Çark (304)	90 \$
Soğutma Fan Kapağı	32 \$
Motor Arka Kapak	48 \$

65-40-125	USD
Gövde	483 \$
Araparça (Motor Ön Flanş)	173 \$
CY Yatak (1.5T / 2.2T)	116 \$
CY Yatak (3.0T)	132 \$
CY Mil	361 \$
Kapak	35 \$
Mek. Salmastra Ø25	48 \$
Çark (316)	158 \$
Çark (304)	78 \$
Soğutma Fan Kapağı	32 \$
Motor Arka Kapak	48 \$

65-40-160	USD
Gövde	469 \$
Araparça (Motor Ön Flanş)	195 \$
CY Yatak	132 \$
CY Mil	361 \$
Kapak	43 \$
Mek. Salmastra Ø25	50 \$
Çark (316)	144 \$
Çark (304)	72 \$
Soğutma Fan Kapağı	25 \$
Motor Arka Kapak	48 \$

65-40-200	USD
Gövde	534 \$
Araparça (Motor Ön Flanş)	188 \$
CY Yatak	156 \$
CY Mil	361 \$
Kapak	65 \$
Mek. Salmastra Ø25	50 \$
Çark (316)	194 \$
Soğutma Fan Kapağı	32 \$
Motor Arka Kapak	48 \$

65-50-125	USD
Gövde	909 \$
Araparça (Motor Ön Flanş)	130 \$
CY Yatak	132 \$
CY Mil	361 \$
Kapak	72 \$
Mek. Salmastra Ø25	50 \$
Çark (316)	120 \$
Çark (304)	66 \$
Soğutma Fan Kapağı	32 \$
Motor Arka Kapak	48 \$

65-50-160	USD
Gövde	1.039 \$
Araparça (Motor Ön Flanş)	180 \$
CY Yatak	156 \$
CY Mil	361 \$
Kapak	72 \$
Mek. Salmastra Ø25	50 \$
Çark (316)	144 \$
Çark (304)	72 \$
Soğutma Fan Kapağı	32 \$
Motor Arka Kapak	58 \$

65-50-200	USD
Gövde	1.140 \$
Araparça (Motor Ön Flanş)	245 \$
CY Yatak	156 \$
CY Mil	361 \$
Kapak	144 \$
Mek. Salmastra Ø25	50 \$
Çark (316)	202 \$
Soğutma Fan Kapağı	48 \$
Motor Arka Kapak	115 \$

80-65-125	USD
Gövde	1.024 \$
Araparça (Motor Ön Flanş)	231 \$
CY Yatak	132 \$
CY Mil	469 \$
Kapak	72 \$
Mek. Salmastra Ø25	50 \$
Çark (316)	312 \$
Çark (304)	156 \$
Soğutma Fan Kapağı	32 \$
Motor Arka Kapak	48 \$

80-65-160	USD
Gövde	1.147 \$
Araparça (Motor Ön Flanş)	296 \$
CY Yatak	156 \$
CY Mil	469 \$
Kapak	144 \$
Mek. Salmastra Ø25	50 \$
Çark (316)	372 \$
Çark (304)	198 \$
Soğutma Fan Kapağı	48 \$
Motor Arka Kapak	115 \$

80-65-200	USD
Gövde	1.190 \$
Araparça (Motor Ön Flanş)	397 \$
CY Yatak	156 \$
CY Mil	469 \$
Kapak	144 \$
Mek. Salmastra Ø30	79 \$
Çark (316)	540 \$
Soğutma Fan Kapağı	101 \$
Motor Arka Kapak	115 \$

100-80-160	USD
Gövde	1.399 \$
Araparça (Motor Ön Flanş)	361 \$
CY Yatak	132 \$
CY Mil	469 \$
Kapak	79 \$
Mek. Salmastra Ø25	50 \$
Çark (316)	372 \$
Soğutma Fan Kapağı	72 \$
Motor Arka Kapak	115 \$

100-80-200	USD
Gövde	1.435 \$
Araparça (Motor Ön Flanş)	483 \$
CY Yatak	156 \$
CY Mil	469 \$
Kapak	130 \$
Mek. Salmastra Ø30	79 \$
Çark (316)	546 \$
Soğutma Fan Kapağı	108 \$
Motor Arka Kapak	115 \$

VARAN YEDEK PARÇA FİYAT LİSTESİ

CES 40-16

Gövde	9.233 ₺
Ara Parça 4-7.5kW (1681)	6.048 ₺
Ara Parça 11kW (1086)	6.072 ₺
Çark(Pik)	1.896 ₺
Mil	4.014 ₺
Mek. salmas. (CA/SIC/VIT) 024 Burgman	Syf.115
O-ring	251 ₺
Mil Somunu	251 ₺
Kama	201 ₺

CES 40-20

Gövde	9.701 ₺
Ara Parça 7.5-11kW (1090)	7.878 ₺
Ara Parça 15kW (1072-1)	10.186 ₺
Çark(Pik)	2.807 ₺
Mil	4.014 ₺
Mek. salmas. (CA/SIC/VIT) 024 Burgman	Syf.115
O-ring	251 ₺
Mil Somunu	251 ₺
Kama	201 ₺

CES 40-26

Gövde	13.615 ₺
Ara Parça 15-22kW 3000 d/d (1081-1)	11.090 ₺
Ara Parça 30kW 3000d/d (1111-1)	12.026 ₺
Ara Parça 1.1-3kW 1500 d/d (1479-1)	6.490 ₺
Çark(Pik)	4.886 ₺
Mil 3000 d/d - 1500 d/d	5.620 ₺
Mek. salmas. (CA/SIC/VIT) 024 Burgman	Syf.115
O-ring	251 ₺
Mil Somunu	251 ₺
Kama	201 ₺

CES 40-32

Gövde	19.954 ₺
Ara Parça 30-37kW 3000 d/d (1141)	15.723 ₺
Ara Parça 2.2-5.5kW 1500 d/d (1231-1)	11.090 ₺
Çark(Pik)	6.781 ₺
Mil 3000 d/d - 1500 d/d	5.888 ₺
Mek. salmas. (CA/SIC/VIT) 032 Burgman	Syf.115
O-ring	251 ₺
Mil Somunu	251 ₺
Kama	201 ₺

CES 50-20

Gövde	12.193 ₺
Ara Parça 11 kW(1090)	7.912 ₺
Ara Parça 15-22kW (1072-1)	10.186 ₺
Ara Parça 3-5.5kW (1601)	7.878 ₺
Çark(Pik)	2.807 ₺
Mil	4.282 ₺
Mek. salmas. (CA/SIC/VIT) 024 Burgman	Syf.115
O-ring	251 ₺
Mil Somunu	251 ₺
Kama	201 ₺

CES 50-26

Gövde	15.522 ₺
Ara Parça 18.5-22kW 3000 d/d(1081-1)	11.090 ₺
Ara Parça 30-37kW 3000 d/d (1111-1)	19.570 ₺
Ara Parça 2.2-5.5kW 1500 d/d (1479-1)	6.975 ₺
Çark(Pik)	4.705 ₺
Mil 3000 d/d - 1500 d/d	5.620 ₺
Mek. salmas. (CA/SIC/VIT) 024 Burgman	Syf.115
O-ring	251 ₺
Mil Somunu	251 ₺
Kama	201 ₺

CES 50-32

Gövde	22.380 ₺
Ara Parça 30-37kW 3000 d/d (1111-1)	15.723 ₺
Ara Parça 4-11kW 1500 d/d (1231)	10.705 ₺
Çark(Pik)	6.784 ₺
Mil 3000 d/d - 1500 d/d	5.888 ₺
Mek. salmas. (CA/SIC/VIT) 032 Burgman	Syf.115
O-ring	251 ₺
Mil Somunu	251 ₺
Kama	201 ₺

CES 65-13

Gövde	11.090 ₺
Ara Parça 4-11kW (1065)	4.667 ₺
Çark(Pik)	2.334 ₺
Mil	3.613 ₺
Mek. salmas. (CA/SIC/VIT) 024 Burgman	Syf.115
O-ring	251 ₺
Mil Somunu	251 ₺
Kama	201 ₺

CES 65-16

Gövde	14.017 ₺
Ara Parça 7.5-11kW (1086)	5.536 ₺
Ara Parça 15-18.5kW (1067)	9.233 ₺
Çark(Pik)	2.807 ₺
Mil	4.014 ₺
Mek. salmas. (CA/SIC/VIT) 024 Burgman	Syf.115
O-ring	251 ₺
Mil Somunu	251 ₺
Kama	201 ₺

CES 65-20

Gövde	15.121 ₺
Ara Parça 15-22kW (1072-1)	10.186 ₺
Ara Parça 30kW (1068-1)	11.642 ₺
Ara Parça 3-5.5kW (1601)	6.072 ₺
Çark(Pik)	3.756 ₺
Mil	5.620 ₺
Mek. salmas. (CA/SIC/VIT) 024 Burgman	Syf.115
O-ring	251 ₺
Mil Somunu	251 ₺
Kama	201 ₺

CES 65-26

Gövde	17.011 ₺
Ara Parça 22kW 3000 d/d(1081-2)	11.642 ₺
Ara Parça 30-37kW 3000 d/d (1111-1)	12.562 ₺
Ara Parça 3-5.5kW 1500 d/d (1479-2)	6.490 ₺
Ara Parça 7.5kW (1506)	7.427 ₺
Çark(Pik)	6.218 ₺
Mil 3000 d/d - 1500 d/d	6.022 ₺
Mek. salmas. (CA/SIC/VIT) 032 Burgman	Syf.115
O-ring	251 ₺
Mil Somunu	251 ₺
Kama	201 ₺

CES 65-32

Gövde	28.569 ₺
Ara Parça 5,5-11kW 1500 d/d (1231)	10.705 ₺
Çark(Pik)	8.188 ₺
Mil 1500 d/d	4.014 ₺
Mek. salmas. (CA/SIC/VIT) 032 Burgman	Syf.115
O-ring	251 ₺
Mil Somunu	251 ₺
Kama	201 ₺

CES 80-16

Gövde	16.108 ₺
Ara Parça 11kW (1086)	6.072 ₺
Ara Parça 15-22kW (1067)	9.802 ₺
Çark(Pik)	3.062 ₺
Mil	4.014 ₺
Mek. salmas. (CA/SIC/VIT) 024 Burgman	Syf.115
O-ring	251 ₺
Mil Somunu	251 ₺
Kama	201 ₺

CES 80-20

Gövde	17.496 ₺
Ara Parça 3-5.5kW (1601)	6.072 ₺
Ara Parça 18.5-22kW (1072-2)	10.638 ₺
Ara Parça 30-37kW (1068-2)	12.026 ₺
Çark(Pik)	4.230 ₺
Mil	5.888 ₺
Mek. salmas. (CA/SIC/VIT) 032 Burgman	Syf.115
O-ring	251 ₺
Mil Somunu	251 ₺
Kama	201 ₺

CES 80-26

Gövde	21.928 ₺
Ara Parça 30-37kW 3000 d/d (1111-2)	12.562 ₺
Ara Parça 4-5.5kW 1500 d/d (1479-2)	6.975 ₺
Ara Parça 7.5-11kW 1500 d/d (1506)	7.912 ₺
Çark(Pik)	6.217 ₺
Mil 3000 d/d - 1500 d/d	6.155 ₺
Mek. salmas. (CA/SIC/VIT) 032 Burgman	Syf.115
O-ring	251 ₺
Mil Somunu	251 ₺
Kama	201 ₺

CES 80-32

Gövde	24.822 ₺
Ara Parça (1231)	10.186 ₺
Ara Parça (1653)	15.723 ₺
Çark(Pik)	8.586 ₺
Mil 3000 d/d - 1500 d/d	4.817 ₺
Mek. salmas. (CA/SIC/VIT) 032 Burgman	Syf.115
O-ring	251 ₺
Mil Somunu	251 ₺
Kama	201 ₺

CES 100-20

Gövde	23.317 ₺
Ara Parça 30-45kW (1068-2)	12.026 ₺
Çark(Pik)	4.523 ₺
Mil	6.022 ₺
Mek. salmas. (CA/SIC/VIT) 032 Burgman	Syf.115
O-ring	251 ₺
Mil Somunu	251 ₺
Kama	201 ₺

CES 100-26

Gövde	26.712 ₺
Ara Parça 5.5kW 1500 d/d (1479-2)	6.490 ₺
Ara Parça 7.5-11kW 1500 d/d (1506)	7.510 ₺
Ara Parça 15kW 1500 d/d (1081-2)	11.090 ₺
Çark(Pik)	6.507 ₺
Mil 1500 d/d	4.817 ₺
Mek. salmas. (CA/SIC/VIT) 032 Burgman	Syf.115
O-ring	251 ₺
Mil Somunu	251 ₺
Kama	201 ₺

CES 100-32

Gövde	26.712 ₺
Ara Parça 5.5kW 1500 d/d (1479-2)	6.490 ₺
Ara Parça 7.5-11kW 1500 d/d (1506)	7.510 ₺
Ara Parça 15kW 1500 d/d (1081-2)	11.090 ₺
Çark(Pik)	6.507 ₺
Mil 1500 d/d	4.817 ₺
Mek. salmas. (CA/SIC/VIT) 032 Burgman	Syf.115
O-ring	251 ₺
Mil Somunu	251 ₺
Kama	201 ₺

Not: Mekanik salmastra fiyatları için 115. sayfaya bakınız.

VARAN YEDEK PARÇA FİYAT LİSTESİ

CES-i 40-13

Gövde	9.199 ₺
Ara Parça 2308	3.587 ₺
Çark(Pik)	2.419 ₺
Mil 3000 d/d	2.612 ₺
Mil 1500 d/d	1.698 ₺
Mek. Salmastra (CA/SIC/VIT)	
Ø24 Burgman	Syf.115
O-ring	272 ₺
Mil Somunu	272 ₺
Kama	218 ₺

CES-i 40-16

Gövde	9.199 ₺
Ara Parça 1681	6.654 ₺
Çark(Pik)	2.419 ₺
Mil 3000 d/d	3.021 ₺
Mil 1500 d/d	2.613 ₺
Mek. Salmastra (CA/SIC/VIT)	
Ø24 Burgman	Syf.115
O-ring	272 ₺
Mil Somunu	272 ₺
Kama	218 ₺

CES-i 40-20

Gövde	9.662 ₺
Ara Parça 1601	7.022 ₺
Ara Parça 1090 (11 kw - 3000 d/d)	9.362 ₺
Çark(Pik)	2.552 ₺
Mil 3000 d/d	4.001 ₺
Mil 1500 d/d	2.449 ₺
Mek. Salmastra (CA/SIC/VIT)	
Ø24 Burgman	Syf.115
O-ring	272 ₺
Mil Somunu	272 ₺
Kama	218 ₺

CES-i 50-16

Gövde	7.859 ₺
Ara Parça 1681	5.868 ₺
Ara Parça 1086	5.868 ₺
Çark(Pik)	2.595 ₺
Mil 3000 d/d - 1500 d/d	4.082 ₺
Mek. Salmastra (CA/SIC/VIT)	
Ø24 Burgman	Syf.115
O-ring	272 ₺
Mil Somunu	272 ₺
Kama	272 ₺

CES-i 50-20

Gövde	9.866 ₺
Ara Parça 1601	5.919 ₺
Ara Parça 1090	7.927 ₺
Ara Parça 1072	10.869 ₺
Çark(Pik)	2.725 ₺
Mil 3000 d/d - 1500 d/d	4.287 ₺
Mek. Salmastra (CA/SIC/VIT)	
Ø24 Burgman	Syf.115
O-ring	272 ₺
Mil Somunu	272 ₺
Kama	272 ₺

CES-i 50-26

Gövde	12.843 ₺
Ara Parça 1479	6.923 ₺
Ara Parça 1506	7.927 ₺
Ara Parça 1081	11.839 ₺
Ara Parça 1111	12.843 ₺
Çark(Pik)	5.211 ₺
Mil 3000 d/d - 1500 d/d	5.715 ₺
Mek. Salmastra (CA/SIC/VIT)	
Ø24 Burgman	Syf.115
O-ring	272 ₺
Mil Somunu	272 ₺
Kama	221 ₺

CES-i 65-13

Gövde	11.788 ₺
Ara Parça 2308	3.587 ₺
Çark(Pik)	2.854 ₺
Mil 3000 d/d	3.274 ₺
Mil 1500 d/d	2.095 ₺
Mek. Salmastra (CA/SIC/VIT)	
Ø24 Burgman	Syf.115
O-ring	272 ₺
Mil Somunu	272 ₺
Kama	218 ₺

CES-i 65-16

Gövde	11.788 ₺
Ara Parça 1681	5.477 ₺
Ara Parça 1086	5.868 ₺
Çark(Pik)	2.854 ₺
Mil	4.082 ₺
Mek. Salmastra (CA/SIC/VIT)	
Ø24 Burgman	Syf.115
O-ring	272 ₺
Mil Somunu	272 ₺
Kama	221 ₺

CES-i 65-20

Gövde	15.377 ₺
Ara Parça 1090	7.927 ₺
Ara Parça 1072	10.869 ₺
Ara Parça 1601	5.868 ₺
Çark(Pik)	2.854 ₺
Mil	4.355 ₺
Mek. Salmastra (CA/SIC/VIT)	
Ø24 Burgman	Syf.115
O-ring	272 ₺
Mil Somunu	272 ₺
Kama	221 ₺

CES-i 65-26

Gövde	15.377 ₺
Ara Parça 1081	11.788 ₺
Ara Parça 1111	12.809 ₺
Ara Parça 1479	6.923 ₺
Çark(Pik)	4.171 ₺
Mil 3000 d/d - 1500 d/d	5.715 ₺
Mek. Salmastra (CA/SIC/VIT)	
Ø32 Burgman	Syf.115
O-ring	272 ₺
Mil Somunu	272 ₺
Kama	221 ₺

CES-i 80-16

Gövde	14.254 ₺
Ara Parça 1086	5.868 ₺
Ara Parça 1067	9.866 ₺
Ara Parça 1681	5.868 ₺
Çark(Pik)	3.468 ₺
Mil	4.355 ₺
Mek. Salmastra (CA/SIC/VIT)	
Ø24 Burgman	Syf.115
O-ring	272 ₺
Mil Somunu	272 ₺
Kama	221 ₺

CES-i 80-20

Gövde	16.789 ₺
Ara Parça 1072	10.869 ₺
Ara Parça 1068	12.400 ₺
Ara Parça 1601	5.868 ₺
Çark(Pik)	3.468 ₺
Mil	5.579 ₺
Mek. Salmastra (CA/SIC/VIT)	
Ø24 Burgman	Syf.115
O-ring	272 ₺
Mil Somunu	272 ₺
Kama	221 ₺

CES-i 80-26

Gövde	21.739 ₺
Ara Parça 1081	10.920 ₺
Ara Parça 1111	12.809 ₺
Ara Parça 1479	6.923 ₺
Ara Parça 1506	7.927 ₺
Çark(Pik)	6.322 ₺
Mil 3000 d/d - 1500 d/d	6.124 ₺
Mekanik Salmastra (silisyum)	
Ø32	Syf.115
O-ring	272 ₺
Mil Somunu	272 ₺
Kama	221 ₺

CES-i 100-16

Gövde	17.792 ₺
Ara Parça 1086	5.868 ₺
Ara Parça 1067	9.866 ₺
Ara Parça 1681	5.868 ₺
Çark(Pik)	2.725 ₺
Mil	4.355 ₺
Mek. Salmastra (CA/SIC/VIT)	
Ø24 Burgman	Syf.115
O-ring	272 ₺
Mil Somunu	272 ₺
Kama	221 ₺

CES-i 100-20

Gövde	22.759 ₺
Ara Parça 1072	10.869 ₺
Ara Parça 1068	12.400 ₺
Ara Parça 1601	5.868 ₺
Çark(Pik)	4.171 ₺
Mil	5.988 ₺
Mek. Salmastra (CA/SIC/VIT)	
Ø32 Burgman	Syf.115
O-ring	272 ₺
Mil Somunu	272 ₺
Kama	221 ₺

CES-i 100-26

Gövde	26.655 ₺
Ara Parça 1111	12.809 ₺
Ara Parça 1479	6.923 ₺
Ara Parça 1506	8.726 ₺
Çark(Pik)	6.322 ₺
Mil 1500 d/d	6.124 ₺
Mekanik Salmastra (silisyum)	
Ø32	Syf.115
O-ring	272 ₺
Mil Somunu	272 ₺
Kama	272 ₺

Not: Mekanik salmastra fiyatları için 115. sayfaya bakınız.

VARAN YEDEK PARÇA FİYAT LİSTESİ

ES 40-16

Gövde	9.233 ₺
Ara Parça (1075-1)	4.871 ₺
Yatak (1076)	4.871 ₺
Çark(Pik)	1.896 ₺
Yumuşak salmastra	351 ₺
Glend + Saplama Tk.	636 ₺
Rulman kapağı Ad.	569 ₺
O-ring	268 ₺
Mil Somunu	268 ₺
Mil	3.332 ₺
Kama	217 ₺
Yatak Ayağı	318 ₺

ES 40-20

Gövde	9.701 ₺
Ara Parça (1075-1)	4.399 ₺
Yatak (1076)	4.867 ₺
Çark(Pik)	2.807 ₺
Yumuşak salmastra	351 ₺
Glend + Saplama Tk.	636 ₺
Rulman kapağı Ad.	569 ₺
O-ring	268 ₺
Mil Somunu	268 ₺
Mil	3.332 ₺
Kama	217 ₺
Yatak Ayağı	318 ₺

ES 40-26

Gövde	13.615 ₺
Ara Parça (1127-1)	9.701 ₺
Yatak (1035)	4.700 ₺
Çark(Pik)	4.886 ₺
Yumuşak salmastra	351 ₺
Glend + Saplama Tk.	636 ₺
Rulman kapağı Ad.	569 ₺
O-ring	268 ₺
Mil Somunu	268 ₺
Mil	3.345 ₺
Kama	217 ₺

ES 40-32

Gövde	19.955 ₺
Ara Parça (1146-1)	13.197 ₺
Yatak (1104)	7.326 ₺
Çark(Pik)	6.781 ₺
Yumuşak salmastra	351 ₺
Glend + Saplama Tk.	636 ₺
Rulman kapağı Ad.	569 ₺
O-ring	268 ₺
Mil Somunu	268 ₺
Mil	4.095 ₺
Kama	217 ₺

ES 50-20

Gövde	12.194 ₺
Ara Parça (1075-1)	4.867 ₺
Yatak (1076)	5.336 ₺
Çark(Pik)	2.807 ₺
Yumuşak salmastra	351 ₺
Glend + Saplama Tk.	636 ₺
Rulman kapağı Ad.	569 ₺
O-ring	268 ₺
Mil Somunu	268 ₺
Mil	3.345 ₺
Kama	217 ₺

ES 50-26

Gövde	15.522 ₺
Ara Parça (1127-2)	9.701 ₺
Yatak (1135)	5.336 ₺
Çark(Pik)	4.704 ₺
Yumuşak salmastra	351 ₺
Glend + Saplama Tk.	636 ₺
Rulman kapağı Ad.	569 ₺
O-ring	268 ₺
Mil Somunu	268 ₺
Mil	3.345 ₺
Kama	217 ₺

ES 50-32

Gövde	22.380 ₺
Ara Parça (1146-2)	12.595 ₺
Yatak (1104)	7.326 ₺
Çark(Pik)	6.783 ₺
Yumuşak salmastra	351 ₺
Glend + Saplama Tk.	636 ₺
Rulman kapağı Ad.	569 ₺
O-ring	268 ₺
Mil Somunu	268 ₺
Mil	4.148 ₺
Kama	217 ₺

ES 65-16

GGövde	14.017 ₺
Ara Parça (1775-1)	4.399 ₺
Yatak (1774)	4.867 ₺
Çark(Pik)	2.807 ₺
Yumuşak salmastra	351 ₺
Glend + Saplama Tk.	636 ₺
Rulman kapağı Ad.	569 ₺
O-ring	268 ₺
Mil Somunu	268 ₺
Mil	3.345 ₺
Kama	217 ₺

ES 65-20

Gövde	15.121 ₺
Ara Parça (1075-2)	4.867 ₺
Yatak (1076)	5.336 ₺
Çark(Pik)	3.755 ₺
Yumuşak salmastra	351 ₺
Glend + Saplama Tk.	636 ₺
Rulman kapağı Ad.	569 ₺
O-ring	268 ₺
Mil Somunu	268 ₺
Mil	3.345 ₺
Kama	217 ₺

ES 65-26

Gövde	17.011 ₺
Ara Parça (1127-3)	9.250 ₺
Yatak (1136)	8.313 ₺
Çark(Pik)	6.218 ₺
Yumuşak salmastra	351 ₺
Glend + Saplama Tk.	636 ₺
Rulman kapağı Ad.	569 ₺
O-ring	268 ₺
Mil Somunu	268 ₺
Mil	4.095 ₺
Kama	217 ₺

ES 65-32

Gövde	28.569 ₺
Ara Parça (1146-3)	12.595 ₺
Yatak (1136)	8.313 ₺
Çark(Pik)	8.187 ₺
Yumuşak salmastra	351 ₺
Glend + Saplama Tk.	636 ₺
Rulman kapağı Ad.	569 ₺
O-ring	268 ₺
Mil Somunu	268 ₺
Mil	4.095 ₺
Kama	217 ₺

ES 80-16

Gövde	16.108 ₺
Ara Parça (1775-1)	4.399 ₺
Yatak (1774)	4.867 ₺
Çark(Pik)	3.062 ₺
Yumuşak salmastra	351 ₺
Glend + Saplama Tk.	636 ₺
Rulman kapağı Ad.	569 ₺
O-ring	268 ₺
Mil Somunu	268 ₺
Mil	3.345 ₺
Kama	217 ₺

ES 80-20

Gövde	17.496 ₺
Ara Parça (1075-3)	4.867 ₺
Yatak (1104)	7.326 ₺
Çark(Pik)	4.230 ₺
Yumuşak salmastra	351 ₺
Glend + Saplama Tk.	636 ₺
Rulman kapağı Ad.	569 ₺
O-ring	268 ₺
Mil Somunu	268 ₺
Mil	4.095 ₺
Kama	217 ₺

ES 80-26

GGövde	24.822 ₺
Ara Parça (1146-7)	12.595 ₺
Yatak (1136-1)	8.313 ₺
Çark(Pik)	8.586 ₺
Yumuşak salmastra	351 ₺
Glend + Saplama Tk.	636 ₺
Rulman kapağı Ad.	569 ₺
O-ring	268 ₺
Mil Somunu	268 ₺
Mil	4.095 ₺
Kama	217 ₺

ES 100-20

Gövde	23.317 ₺
Ara Parça (1075-4)	4.867 ₺
Yatak (1104)	7.326 ₺
Çark(Pik)	4.523 ₺
Yumuşak salmastra	351 ₺
Glend + Saplama Tk.	636 ₺
Rulman kapağı Ad.	569 ₺
O-ring	268 ₺
Mil Somunu	268 ₺
Mil	4.095 ₺
Kama	217 ₺

ES 100-26

Gövde	26.712 ₺
Ara Parça (1127-3)	9.250 ₺
Yatak (1136)	8.313 ₺
Çark(Pik)	6.507 ₺
Yumuşak salmastra	351 ₺
Glend + Saplama Tk.	636 ₺
Rulman kapağı Ad.	569 ₺
O-ring	268 ₺
Mil Somunu	268 ₺
Mil	4.095 ₺
Kama	217 ₺

ES 100-32

Gövde	25.826 ₺
Ara Parça (1146-7)	12.595 ₺
Yatak (1136-1)	8.313 ₺
Çark(Pik)	8.968 ₺
Yumuşak salmastra	351 ₺
Glend + Saplama Tk.	636 ₺
Rulman kapağı Ad.	569 ₺
O-ring	268 ₺
Mil Somunu	268 ₺
Mil	4.095 ₺
Kama	217 ₺

VARAN YEDEK PARÇA FİYAT LİSTESİ

HİDROFORLAR

TANK FLANŞI	USD
24 Lt-150 Lt 1"	\$17
300 Lt-500 Lt 1 1/4"	\$52
750 Lt-2000 Lt 2"	\$76

BEŞYOLLU (T) BAĞL.	USD
1"	\$16
1 1/4"	\$40

ŞALTER	USD
Yerli	\$36
Hidrokit Kartı	\$55

MONOMETRE	TL
0 - 10	180₺
0 - 16	180₺

MEBRAN	USD
24 Lt	\$10
50 Lt	\$22
80 Lt	\$38
100 Lt	\$38
150 Lt	\$71
200 Lt	\$71
300 Lt	\$84
500 Lt	\$144
750 Lt	\$233
1000 Lt	\$233

FLATÖR (Şamandıra)	USD
5 MT KABLÖLÜ	\$35
10 MT KABLÖLÜ	\$57
ATIK SU 5 MT. (Armut tip)	\$66
ATIK SU 10 MT. (Armut tip)	\$91

PVM HİDROF. SAC ŞASE	TL
Tekli	274₺
İkili	652₺
Üçlü	1.002₺
Takoz Ayak / adet	34₺

VF 20 (3")	TL
Üst Kapak	870₺
Mot.Gövde	3.479₺
Pompa Gövde	3.914₺
Emici	1.606₺
Çark	1.606₺
Kablo(Tk)	1.572₺
Keçe Ø 22(Silisyumlu)	2.844₺
Flanş	1.037₺
Araparça	987₺

4" DALGIÇ YEDEK PARÇA TL

	1 1/4" & 1.5"	2"
Çark	100₺	217₺
Difüzör Kademe	201₺	251₺
Kademe Kapağı	100₺	100₺
Orta Denge Yatağı	134₺	217₺
Klape Gövde	987₺	1.204₺
Klape Sübap Gövdesi	234₺	251₺
Klape	100₺	100₺
Denge Burcu	100₺	100₺
Kablo Muhafazası	301₺	301₺
Lastik Burç Yatağı	100₺	100₺
Burç	151₺	151₺
Kablo	569₺	569₺
Kaplin	418₺	418₺
Filtre	335₺	335₺
Emiş Gövdesi	1.054₺	1.321₺
Kumanda Kutusu	1.622₺	1.622₺
Mil (TL/cm)	23₺	23₺

ENDÜSTRİYEL DRENAJLAR TL

VF15-275, VF25-275, VF50-455, VF48-475, VF65-410, VF100-610

Üst Kapak	3.245₺
Alt Mot.Kapak (Araparça):	3.245₺
Pom.Gövde	6.824₺
Emici	2.844₺
Çark	2.844₺

Mekanik Salmastra

VF50,VF48,VF25 (Ø25) :	6.222₺
VF15 (Ø30)	8.631₺
VF65, VF100 (10HP) (Ø35)	8.631₺
Kablo(Tk)	2.743₺
Dirsek	2.108₺

VF100-415 & VF150-615

Üst Kapak	3.379₺
Alt Mot.Kapak	3.379₺
Pompa Gövde	7.795₺
Emici	3.245₺
Çark	3.245₺

Mekanik Salmastra

(Ø40)	10.370₺
Kablo(Tk)	3.094₺
Kablo Kapak	1.857₺
Dirsek	4.165₺

MANUEL TİP HİDROFOR PANOLARI (USD)

(Termik+Motor Koruma+Hidrofor sıralı çalışma rölesi çok pompalı gruplarda + arıza ikaz ledleri)

	1 Pompa	2 Pompa	3 Pompa
5.5 HP (380V)	\$244	\$438	\$570
7.5 HP (380V)	\$250	\$450	\$592
10 HP (380V)	\$261	\$494	\$678
15 HP (380/660V)	\$357	\$689	\$1.013
20 HP (380/660V)	\$379	\$765	\$1.114
25 HP (380/660V)	\$408	\$840	\$1.199
30 HP (380/660V)	\$413	\$848	\$1.379
40 HP (380/660V)	\$713	\$1.659	\$2.389
50 HP (380/660V)	\$713	\$1.659	\$2.389
60 HP (380/660V)	\$899	\$2.053	\$2.902
75 HP (380/660V)	\$999	\$2.251	\$3.447
100 HP (380/660V)	\$1.186	\$3.108	\$4.071
125 HP (380/660V)	\$1.615		
150 HP (380/660V)	\$1.993		
SSR İLAVESİ	\$47		

ELEKTRONİK PANOLAR

(HİDROFOR & DALGIÇ & DRENAJ PANOLARI)

LED EKRANLI

1 POMPALI	EURO
1-3 HP (220V)	\$93
1-7.5 HP (380V)	\$93

LCD EKRANLI OTO-TEST ÖZELLİKLİ

1 POMPALI	EURO
1-3 HP (220V)	\$126
1-7.5 HP (380V)	\$126
10 HP (380V) KONT.	\$251
15 HP (380V) KONT.	\$265

2 POMPALI

1-3 HP (220V) KONT.	\$252
1-7.5 HP (380V) KONT.	\$265
10 HP (380V) KONT.	\$279
15 HP (380V) KONT.	\$318

3 POMPALI

1-3 HP (220V) KONT.	\$318
1-7.5 HP (380V) KONT.	\$331
10 HP (380V) KONT.	\$351
15 HP (380V) KONT.	\$397

SU BORULARINDAKİ SÜRTÜNME KAYBI HESAP CETVELİ

PLASTİK BORU DIŞ ÇAPI		25	32	40	50	63	75	90	110	140	160	200	225	280		
PLASTİK BORU ANMA ÇAPI		20	25	32	40	50	65	80	100	125	150	175	200	250		
METAL SU BORULARI		3/4"	1"	1"1/4"	1"1/2"	2"	2"1/2"	3"	4"	5"	6"	7"	8"	10"		
m ³ /h	l/min	l/s	DÜZ DÖKÜM BORULARIN HER 100 METRESİNDEKİ SÜRTÜNME KAYBI (metre)													
1,2	20	0,3	10,4	3,7	1	0,3										
1,5	25	0,4	15,8	5,7	1,5	0,5										
1,8	30	0,5	22,3	8	2,1	0,7										
2,1	35	0,6	29,8	10,8	2,8	0,9	0,3		PVC boru için çarpan					0,65		
2,4	40	0,7	38,2	13,8	2,7	1,2	0,4		Alüminyum boru için çarpan					0,70		
3	50	0,8	58,2	21,1	8	1,8	0,6		Yeni çelik boru için çarpan					0,80		
3,6	60	1	82	30	10,8	2,5	0,9		Az paslı çelik boru için çarpan					1,25		
4,2	70	1,2		40	13,9	3,3	1,1									
4,8	80	1,3		51,5	17,5	4,3	1,5									
5,4	90	1,5		64	21,4	5,4	1,8	0,5								
6	100	1,7		79	33	6,6	2,2	0,6								
7,5	125	2,1			47	10	3,4	0,9								
9	150	2,5			63	14,2	4,7	1,2	0,4							
10,5	175	2,9			82	19	6,3	1,6	0,6							
12	200	3,3				24,5	8,1	2,1	0,7							
15	250	4,2				37,5	12,3	3,2	1,1	0,4						
18	300	5				53	17,3	4,5	1,6	0,5						
24	400	6,7					29,5	7,8	2,7	0,9						
30	500	8,3					44,8	12	4,1	1,4	0,5					
36	600	10						16,9	5,8	1,9	0,7					
42	700	11,7						22,6	7,8	2,6	0,9					
48	800	13,3						29	10	3,4	1,2	0,4				
54	900	15						36	12,5	4,2	1,5	0,5				
60	1000	16,7							15,2	5,1	1,8	0,7				
75	1250	20,8							23	7,9	2,7	1	0,5			
90	1500	25							32,6	11,2	3,8	1,4	0,7			
105	1750	29,2								15	5	1,9	0,9	0,5		
120	2000	33,3								19,4	6,5	2,4	1,2	0,6		
150	2500	41,7								30	9,8	3,8	1,8	0,9		
180	3000	50									13,8	5,3	2,5	1,3		
240	4000	66,7									23,8	9,1	4,4	2,2	0,7	
300	5000	83,3										13,9	6,6	3,3	1,1	
360	6000	100										20	9,5	4,7	1,6	
420	7000	116,7											12,8	6,4	2,1	
480	8000	133,3												21	10,5	3,5

KAT VE DAİRE SAYISINA GÖRE PRATİK HİDROFOR SEÇİM TABLOSU
KAT SAYISINA GÖRE BASINÇ TAYİNİ

Kat Sayısı	Basınç (bar)
1	2.4
2	2.8
3	3.1
4	3.5
5	3.8
6	4.1
7	4.5
8	4.8
9	5.2
10	5.5
11	5.9
12	6.2
13	6.6
14	6.9
15	7.3
16	7.6
17	7.9
18	8.3
19	8.6
20	9
21	9.3
22	9.7
23	10
24	10.4
25	10.7
26	11.5
27	11.4
28	11.7
29	12.1
30	12.4

DAİRE SAYISINA GÖRE DEBİ TAYİNİ

Daire Sayısı	Q (m ³ /h)	Daire Sayısı	Q (m ³ /h)
1	0.4	31	6.5
2	0.8	32	6.7
3	1.2	33	6.9
4	1.6	34	7.2
5	1.2	35	7.4
6	1.44	36	7.6
7	1.7	37	7.8
8	2	38	8
9	2.2	39	8.2
10	2.4	40	8.4
11	2.3	41	8.6
12	2.5	42	8.8
13	2.7	43	9
14	2.9	44	9.3
15	3.2	45	9.5
16	3.4	46	9.7
17	3.6	47	9.9
18	3.8	48	10.1
19	4	49	10.3
20	4.2	50	10.5
21	4.4	51	10.7
22	4.6	52	10.9
23	4.8	53	11.1
24	5	54	11.3
25	5.3	55	11.6
26	5.5	56	11.8
27	5.7	57	12
28	5.9	58	12.2
29	6.1	59	12.4
30	6.3	60	12.6

UYGUN HİDROFORUN SEÇİLMESİ İÇİN BİLİNMESİ GEREKENLER

- 1- Birden çok kullanıcının aynı sistemden faydalandığı, kullanım miktarının günün değişik zaman dilimlerine göre değiştiği uygulamalarda, toplam hesap edilen debi gereksiniminin birden çok pompa ile karşılanması daha doğrudur. Örneğin hesap edilen toplam debi gereksinimi 30 m³/h ise burada tek pompalı hidrofor sistemi seçimi yerine beheri 15 m³/h kapasiteli 2 pompalı veya beheri 10 m³/h kapasiteli 3 pompalı sistemler tercih edilmelidir.
- 2- Pompalardan birinin arızasından dolayı devre dışı kalması gibi durumunda eğer yedek pompa bulunması arzu ediliyor ise sistemi oluşturan pompaların her birinin debisindeki başka bir pompa kullanılmalıdır. Örneğin böyle bir durumda toplam debi gereksinimi 30 m³/h ise, beheri 30 m³/h kapasiteli 2 pompalı bir sistem veya beheri 15m³/h kapasiteli 3 pompalı bir sistem kurulmalıdır.
- 3- Seçilen pompaların istenen debide çalışacağı alt ve üst basınç noktaları pompa eğrisinin verimli noktasına yakın olmalıdır.
- 4- Hidroforda kullanılan pompaların emiş yapacağı depo veya rezerv, pompa montaj seviyesinden aşağıda ise sipariş esnasında bu konu mutlaka belirtilmelidir.
- 5- Eğer pompalanacak suda fiziksel ve kimyasal aşındırıcılar bulunuyor ise sipariş esnasında bu durum mutlaka bildirilmelidir. Pompa ve tesisat oluşturan parçaların bu tip işlerde özel olarak seçilmesi gerekir.
- 6- Kullanılacak membranlı basınç takınlarının seçimi önemlidir. Mümkün olduğunca büyük hacimli tankların kullanılması uygun olacaktır. Ayrıca tanklar için üreticilerin verdiği maksimum basınç değeri hidrofor sisteminde kullanılan pompaların kapalı vana basınçlarından yüksek olmalıdır.

Tablo-1

Örnek Mekanlar İçin Kişi Başına Su Tüketimi	
Yerleşim Tipi	Kişi Başına Günlük Tüketim (lt/kişi)
Konut (lavabolu)	60 - 80
Konut (Duşlu)	80 - 115
Konut (Küvetli)	120 - 200
Otel (Duşlu)	100
Otel (Küvetli)	150 - 200
Hastane	200 - 500
Okul	5
Çocuk Yuvası	80 - 100
Kreş	100 - 150
Kışla	60 - 80
Lokanta	10 - 20
Bahçe Sulama	1,5 lt/m ² bir seferde
Araba Yıkama	100 lt/gün

Tablo-2

Kişi Başına Su Tüketimi İçin Çarpma Faktörü	
Yerleşim Tipi	(K) Faktörü
Konutlar (1 - 5 daire)	0,66
Konutlar (6 - 10 daire)	0,45
Konutlar (11 - 20 daire)	0,40
Konutlar (21 - 50 daire)	0,35
Konutlar (51 - 100 daire)	0,30
Konutlar (100 daire üstü)	0,25
Oteller (1 - 20 yataklı)	0,40
Oteller (21 - 50 yataklı)	0,40 - 0,30
Oteller (50 yatak üstü)	0,30 - 0,20
Hastaneler (50 - 500 yataklı)	0,30 - 0,20
Hastaneler (501 - 1000 Yataklı)	0,20 - 0,15
Hasaneler (1001 - 2000 Yataklı)	0,15 - 0,10
Okullar	0,30
Çocuk Yuvaları	0,40
Kışlalar	0,40 - 0,30
İş Hanları	0,30

UYGUN HİDROFOR SEÇİMİ

Yandaki tabolardaki daire sayısı ve kat adedi altında belirtilen değerler esas alınarak örnekler hesaplanmıştır. Ancak değişik kullanım amaçları ve yerleri için uygun hidrofor seçimi aşağıda açıklandığı şekilde yapılabilir.

GEREKLİ BASINCIN HESABI

$$H_{min} (mss) = h + hk + hc$$

h Hidroforun yerleştirildiği yer ile binanın su basılacak en üst noktası arasındaki kot farkı (mt) (Kat sayısı x Kat yüksekliği)

hk Tesisattaki vana, dirsek, su sayacı, boru vs. kayıpları toplamı (Bu değer genellikle toplam h yüksekliğinin % 20 si olarak alınır) (mt)

hc Binaının en üst seviyesinde olması istenen çıkış basıncıdır. Genellikle 10 - 15 mt arası alınır.

GEREKLİ DEBİNİN HESABI

$$Q_{min} (m^3/h) = \text{Daire Sayısı} \times \text{Dairedeki Kişi Sayısı} \times \text{Kişi başı günlük tüketim} \times K/1000$$

Kişi başı günlük tüketim: Tablo 1'den seçilir. (lt/gün)
K: Eş zamanlı faktörü (Tablo 2'den seçilir.)

Örnek Hesaplama

6 Kat, 21 daireli bir bina (konut) için basınç, debi tayini ve pompa seçimi:

$$h = 6 \text{ kat} \times 2,8 \text{ (tek kat yüksekliği)} = 16,8 \text{ mss}$$

$$hk = 0,2 \times h = 0,2 \times 16,8 = 3,4 \text{ mss}$$

$$hc = 10 \text{ mss}$$

$$H_{min} = h + hk + hc = 16,8 + 3,4 + 10 = 30,2 \text{ mss}$$

Daire Sayısı: 21

Dairedeki kişi sayısı: 5 kişi

Kişi başı günlük tüketim : 100 lt (Tablo 1)

Eş zamanlı kullanım fak. K:0,35 (Tablo 2)

$$\text{Debi, } Q = 21 \times 5 \times 100 \times 0,35 / 1000 = 3,7 \text{ m}^3/\text{saat}$$

- Hidrofora alt seviyeden emiş yaptırılmamalıdır. Depo hidroforun yanında veya üst seviyesinde olmalıdır.
- Pompaların su emişinde zorlanmalarını gerekir. Bu nedenle, hidrofor emiş çapları kesinlikle küçültülmemelidir.
- Tek pompalı hidroforlarda pompa su giriş çapı değerinden bir boy büyük, iki ve üç pompalı hidroforlarda ise emiş kollektörü çapında emiş tesisatı çekilmelidir.

KABLO SEÇİM CETVELİ

GERİLİM	MOTOR GÜCÜ		Kablo kesidi 4* mm											
	VOLTAJ	kW	Hp	1,5	2,5	4	6	10	16	25	35	50	70	95
220	0,37	0,55		80	130									
	0,55	0,75		55	90	140								
	0,75	1		40	80	105	160							
	1,1	1,5		30	50	75	115	190						
	1,5	2		20	35	60	90	145	235					
	2,2	3			30	50	70	120	185					
380	0,37	0,55		570										
	0,55	0,75		379										
	0,75	1		230										
	1,1	1,5		180	235									
	1,5	2		135	225	360								
	2,2	3		100	165	285	390							
	3	4		65	110	180	225	420						
	4	5,5		50	85	135	195	330	500					
	5,5	7,5		40	70	110	165	270	420					
	7,5	10			60	100	150	250	410					
	9	12,5			50	80	120	205	330	560				
11	15				60	160	170	280	440					
380 Yıldız Üçgen	16	20				80	110	260	310	490				
	18,5	25				60	90	160	250	400	450			
	22	30				50	70	130	210	340	470			
	26	35				45	65	110	180	290	410			
	30	40					60	100	160	250	360	500		
	37	50					40	80	130	200	290	410		
	45	60						70	110	170	240	350	450	
	55,5	75							80	130	180	260	360	500
	66	90								110	160	230	320	450
	75	100								100	140	200	250	330
	92	125									120	170	230	300

%3 Gerilim düşümü 25 C ortam sıcaklığı

Motor gücüne ve montaj derinliğine göre kablo çapının seçildiği tablo yukarıdadır. Daha büyük beygir gücündeki motorlar için firmamızla temas kurun.

İRTİFA (KOT FARKI) HESABI

EĞİM %	AÇI (a)	SİN a DEĞERİ
5%	3°	0,052
7%	4°	0,07
10%	6°	0,104
15%	8°	0,139
20%	11°	0,19
25%	14°	0,241
30%	17°	0,292
35%	19°	0,325
40%	22°	0,374
45%	24°	0,406
50%	27°	0,453
55%	29°	0,484
60%	31°	0,515
65%	33°	0,544
70%	35°	0,573
75%	37°	0,601

FORMÜL: İrtifa (Kot Farkı) = Sin a x Mesafe

ÖRNEK:

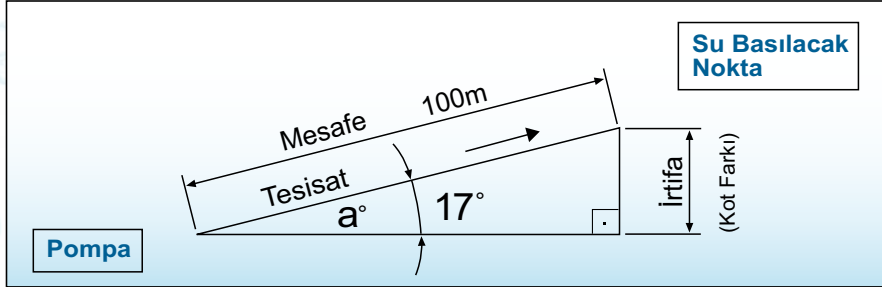

Mesafe= 100 m.

Eğim = %30

Tablodan => 17°

Tablodan => Sin 17°

=0,292

İrtifa (Kot Farkı) = 100 m. x 0.292 = 29.2 Metre

(Pompanın su basacağı noktanın irtifası 29.2 Metredir.)

Not: Akıllı telefonunuza yükleyebileceğiniz "Altimetre" uygulamalarıyla rakımı bulup kot farkı hesaplayabilirsiniz.

Sertifikalarımız



Sertifikalarımız

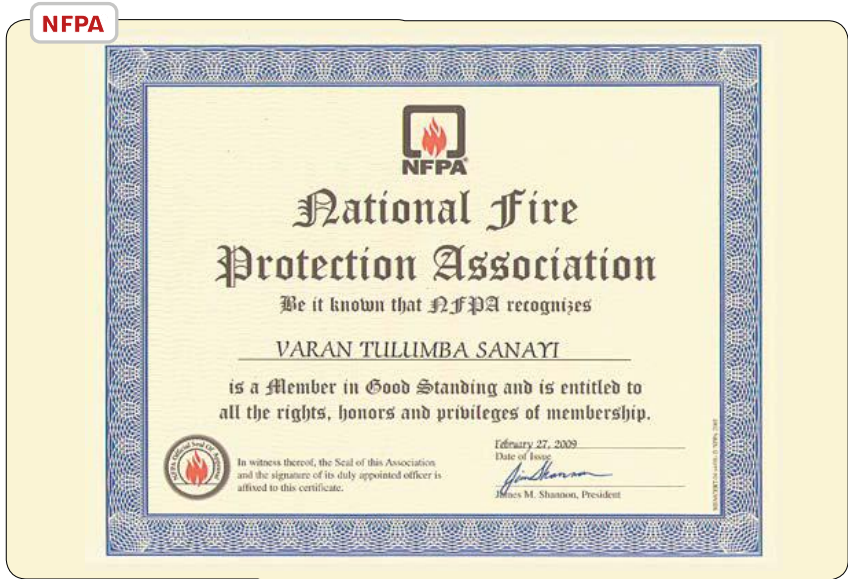

Sertifikalarımız

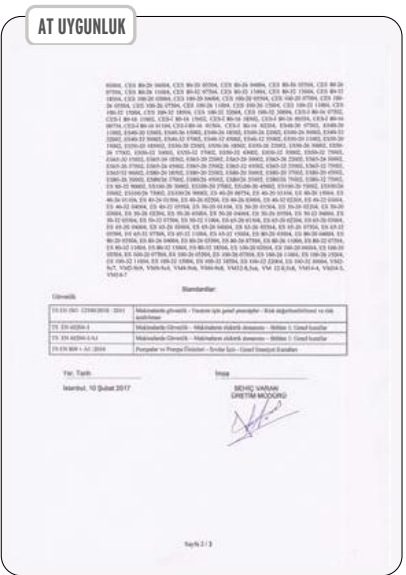
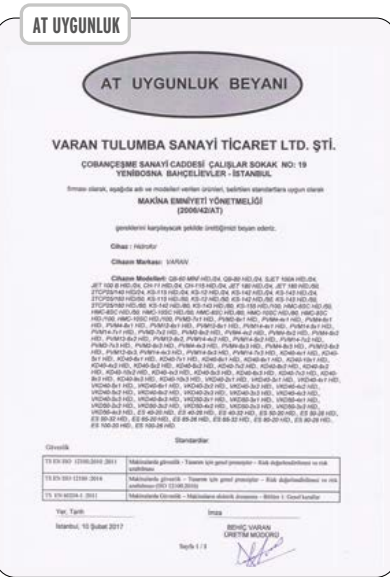

Fabrika ve Üretim Bölümleri



Fabrika ve Üretim Bölümleri



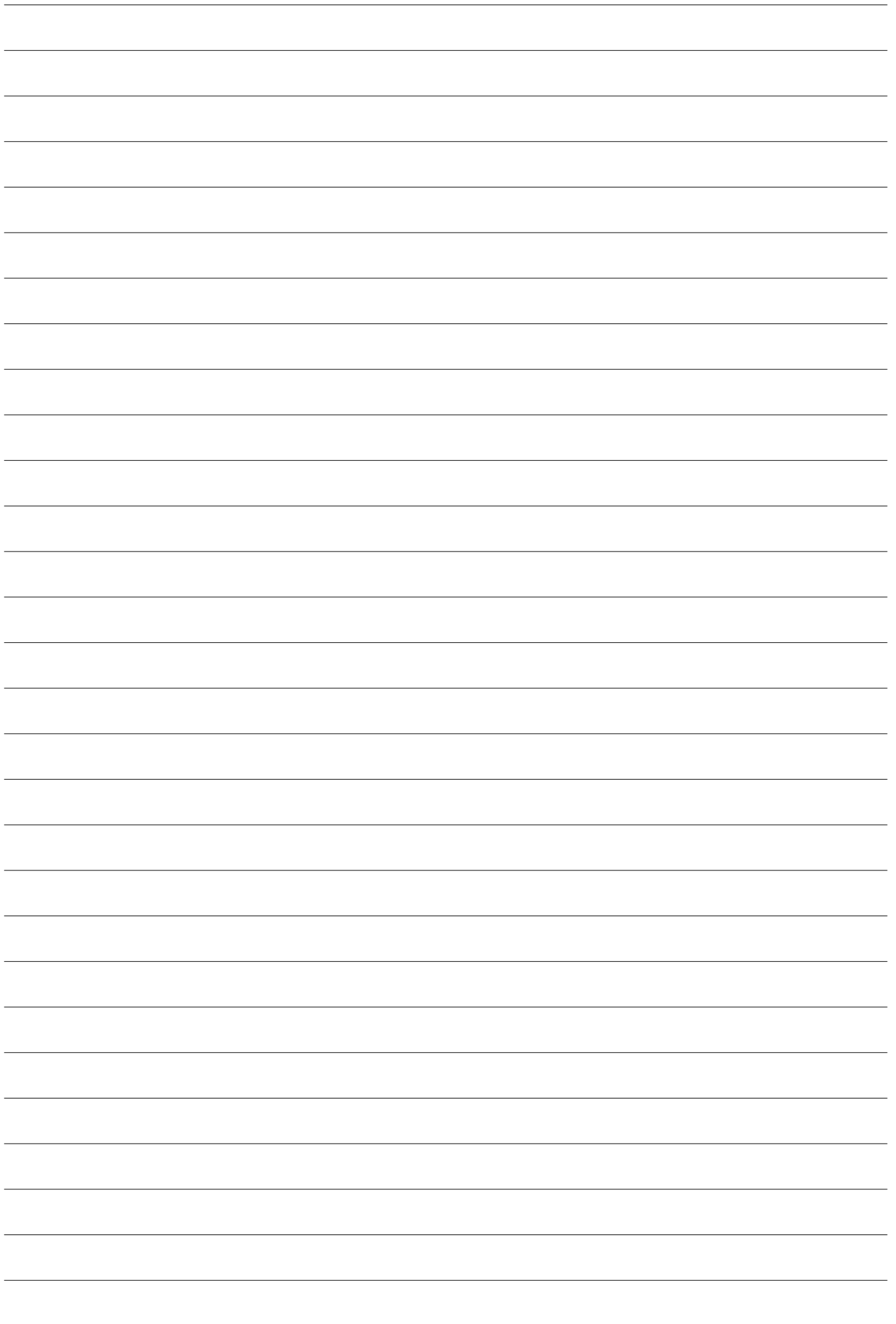



VARAN
POMPA



Whatsapp Destek Hattı
0533 930 34 85

VARAN Tulumba San. ve Tic. Ltd. Şti.

Çobançeşme Mah. Sanayi Cad. Çalışlar 1 Sok. No: 19
Yenibosna-Bahçelievler-İstanbul-TÜRKİYE

Tel : (+90 212) 551 15 30 - 652 60 54 - 503 25 20 - 552 74 55

Fax : (+90 212) 552 97 69

E-mail : varanpompa@varanpompa.com

www.varanpompa.com